

73

June, 1961

37¢

2 for 73¢



NEW! GSB-201

GONSET'S LITTLE POWERHOUSE!



Now at your distributor

RF LINEAR AMPLIFIER

BIG ... with a husky, go-places power rating of 1500 watts PEP ...

SMALL ... only a foot across the front—less than one-and-a-half feet in depth!
No space problem here—these are true “table-top” dimensions.

Fine looking—modern industrial designer styling—finished in durable, attractive light colors. Blends well with existing equipment.

Features and features ...

Full bandswitching 80-40-20-15 and 10 meters • pi network output • stable, efficient grounded grid circuitry • Power input rating: 1500 watts PEP SSB • 1000 watts CW • 400 watts AM • can be driven by exciters in the 65-150 watt category, GSB-100 and similar units • Low cost Type 811A tubes used in amplifier • long life silicon rectifiers replace older vacuum tube rectifiers in high voltage power supply • Antenna changeover relay is built in • panel switch allows tune up at low power • full vision panel instrument is switchable to indicate amplifier plate current or relative RF output • Dimensions, 8½" high, 12⅝" wide, 17" deep.

Model #3340

399⁵⁰



GONSET

Division of Young Spring & Wire Corporation
801 SOUTH MAIN ST., BURBANK, CALIFORNIA

EXPORT SALES: WESTREX CORP., 540 WEST 58TH ST. NEW YORK 19, N. Y.

Amateur Crystals

**1000 KC to
137 MC - .01%
TOLERANCE**

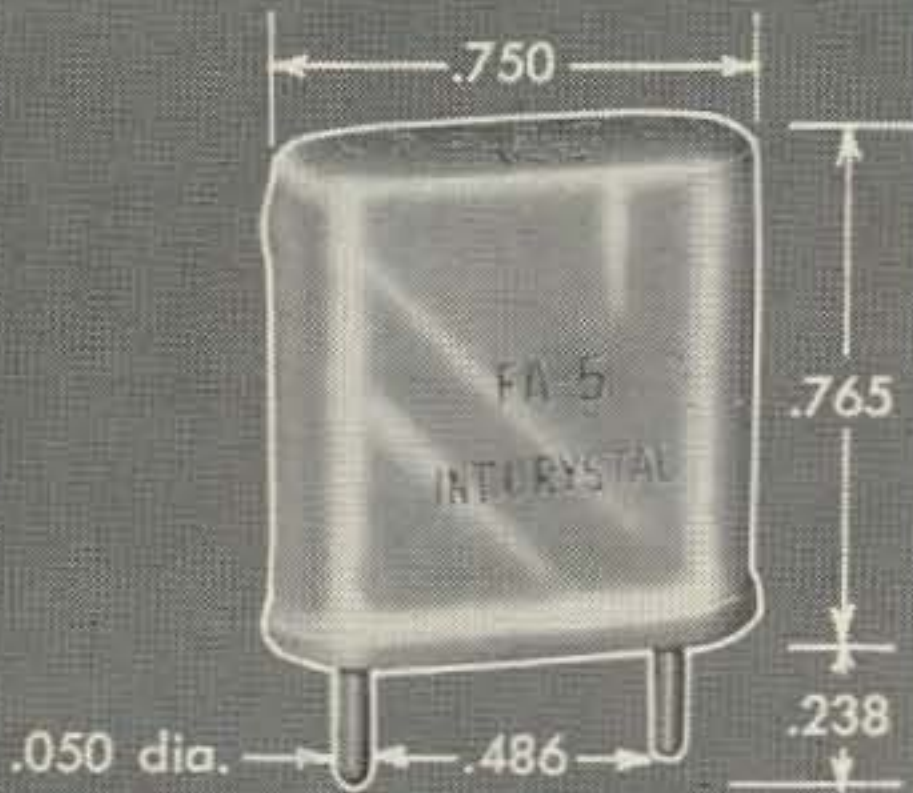

New!
MINIATURIZED
FM-9 SERIES

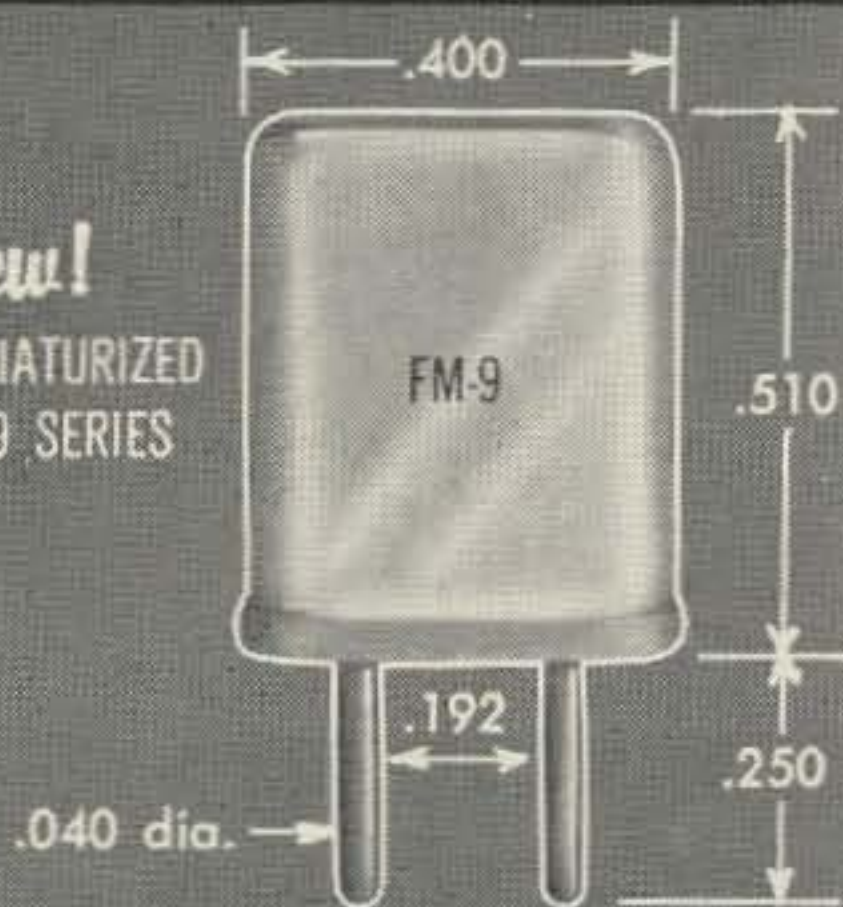

Wire mounted, plated crystals for use by amateurs and experimenters where tolerances of .01% are permissible and wide-range temperatures are not encountered.

Just any crystal in any oscillator will NOT combine to produce spot frequencies. These crystals are designed to operate into a 32 mmf load on their fundamental between 1000 kc and 15000 kc. Overtone crystals operate at anti-resonance on 3rd mode and series resonance on 5th and 7th mode crystals.

- **HOLDERS:** Metal, hermetically sealed. FA-5 and FA-9 are HC/6U pin type while the FM-9 is an HC/18U pin type.
- **FREQUENCIES** (Specify crystal type and frequency when ordering.)

	FA-5 and FA-9	Price	FM-9	Price
Fundamental	1000 - 1499 kc	\$ 5.75	Not available	
	1500 - 1799 kc	\$ 4.95	Not available	
	1800 - 1999 kc	\$ 4.40	Not available	
	2000 - 9999 kc	\$ 3.30	8000 - 9999.999 kc	\$ 5.00
	10000 - 14999 kc	\$ 4.40	10000 - 15000 kc	\$ 5.50
	15000 - 20000 kc	\$ 5.50	15001 - 19999.999 kc	\$ 6.50
Overtone (3rd)	10 - 14.99 mc	\$ 4.40	Not available	
	15 - 29.99 mc	\$ 3.30	20 - 39.99 mc	\$ 5.00
	30 - 59.99 mc	\$ 4.40	40 - 59.99 mc	\$ 5.50
Overtone (5th)	60 - 75.99 mc	\$ 4.95	60 - 89.99 mc	\$ 6.50
	76 - 99.99 mc	\$ 7.15	90 - 100 mc	\$ 8.50
	Not available		101 - 110 mc	\$10.00
Overtone (7th)	100 - 137 mc	\$ 9.35	Not available	

Overtone crystals are calibrated on their overtone frequency. They are valuable for receiver-converter applications and are **NORMALLY NOT UTILIZED IN TRANSMITTERS**, since only a small amount of power is available under stable operating conditions.

- **CALIBRATION TOLERANCE:** $\pm .01\%$ of nominal at 30° C.
- **TEMPERATURE RANGE:** -40° to +70° C. $\pm .01\%$ of frequency at 30° C.
- **DRIVE LEVEL:** Recommended, maximum 3 milliwatts for overtones; up to 80 milliwatts for fundamentals, depending on frequency.

ONE DAY PROCESSING . . .

Orders for less than five crystals will be processed and shipped in one day. Orders received on Monday through Thursdays will be shipped on the day following. Orders received on Friday will be shipped the following Monday.

WRITE FOR 1961 CATALOG FREE!

**INTERNATIONAL
CRYSTAL MANUFACTURING CO., INC.**

18 NORTH LEE • OKLAHOMA CITY, OKLA.



NEW Clegg 99'er 6 METER TRANSCEIVER

A Compact, Top Quality Station for just \$119.⁹⁹!

CHECK THESE EXCLUSIVE 99'er FEATURES:

- Dual Conversion SUPERHET with Squelch, Noise Limiter, S Meter, AVC.
- Low Noise RF Preamplifier.
- Stable — Selective — Vernier Tuning — Built-In Speaker.
- 8 Watt Crystal-Controlled Transmitter.
- 9 Tubes and Rectifier — 14 Tube Performance.
- Completely Wired and Tested with AC Power Supply.
- 6/12 Volt Mobile Adapters Available.

Clegg LABORATORIES

RT. 53, MT. TABOR, N. J. • OAKWOOD 7-6800

Ask your Clegg Distributor (listed below) for full information. He'll be glad to serve you.

Arizona

Southwest Electronic Devices, Phoenix

California

Henry Radio, Los Angeles, Severns, Hemet

Western Radio & TV Supply, San Diego

Mission Ham Supply Co., Riverside

Connecticut

Kaufman Electronics, Bridgeport

Delaware

Delaware Electronics Sup., Wilmington

Florida

Amateur Radio Center, Inc., Miami

Illinois

Allied Radio, Chicago

Indiana

Brown Distributors, Fort Wayne

Van Sickle Radio Supply, Indianapolis

Iowa

World Radio, Council Bluffs

Kansas

Acme Radio & T. V., Hutchinson

Maryland

Key Electronics, Wheaton

Massachusetts

De Mambro Radio Supply, Boston

Radio Shack, Boston

Graham Radio Co., Reading

Michigan

Purchase Radio Supply, Ann Arbor

Radio Parts, Inc., Grand Rapids

Missouri

Henry Radio, Butler

Walter Ashe, St. Louis

New Mexico

Car Parts Depot, Roswell

Valley Engineering, Los Alamos

New Jersey

Federated Purchaser, Mountainside

Terminal-Hudson, Newark

New York

Terminal Electronics, New York

Harrison Radio Corp., New York

North Carolina

Dalton-Hege, Winston-Salem

Ohio

Universal Service, Columbus

Sternbergs, Inc., Cincinnati

Oklahoma

Radio, Inc., Tulsa

Pennsylvania

Tydings Company, Pittsburgh

Eugene G. Wile, Philadelphia

South Carolina

Dixie Radio Supply Company, Sumter

South Dakota

Dakota Supply, Yankton

Virginia

Key Electronics, Arlington

Washington

Radio Supply Company, Seattle

Abe Lincoln	Bill Ashby K2TKN	8
Two meter antenna for mobile or fixed. Looks awful, works great!		
75M Transistorized Converter	Harold Johnson WA6DZL	12
Nice little one evening construction project.		
Precision Capacity Measuring	John Reinartz K6BJ	14
Right down to a fraction of a mmfd.		
Propagation, Part II	Dave Brown K2IGY	16
When the sun spot null will really come and what it will be like.		
73 Tests the M-100 Modulator	Charles Spitz W4API	20
Just how good is that gate modulator put out by Electrotone?		
AM Modulation Monitor	James Tonne W5SUC	24
A bit complicated, but great for perfectionists.		
Modifying the KT-200 Receiver	Bill Orr W6SAI	30
Bill claims this is a real good deal with these few changes.		
Pandapting Adaptor, Part I	John Ellison W6AOI	33
Moderately simple device connects your receiver to your 'scope.		
Automatic Drive Control	Vernon Trexler W5IUR	38
Transistor device keeps you from overmodulation. Clever.		
Dear Sir	Allie Peed K2DHA	39
On writing to manufacturers about your miseries.		
FCC Notice	Wells Chapin W8ONL	41
Thought you'd get a kick out of this bit of antiquity.		
Do-It-Yourself IBM	Jim Kyle K5JKX/6	44
Punch a few holes and get some real mileage out of a card file.		
Power House Pros	Staff	51
Part I, all about power supplies.		
Propagation Chart	Dave Brown K2IGY	54
DX men please note that this is the most accurate forecast in print.		
The DX Hunter	Ken Johnson W6NKE	56
Do's and don'ts of DX hunting.		

Misc.:

Staff:

Table of Contents	3
de W2NSD (editorial)	4
Subscription Rates	6
Whipping Things Up	13
Don't Break Those Good Taps	29
Meter Insulation	32
Field Day Power Source	42
AF MARS Technical Net	43
Subscription Form	post card

editor-publisher	Wayne Green W2NSD
publications manager	David Fish
associate editor	Don Smith W3UZN
associate editor	Jim Kyle K5JKX/6
associate editor	Marvin Lipton VE3DQX
associate editor	Charles Spitz W4API
photographer	Joe Schimmel W2QDM
subscriptions	Virginia
transportation	Old, Beat-Up Porsche
printing	Ye Olde O'briene Presse
Western Representative: Jim Morissett WA6EXU	
Box 847, Reseda, California, Ph: DI 5-2077	

COVER: Couldn't think of anything so we made it bright red!

73 Magazine is published monthly by Amateur Radio Publishing, Inc., 116 Main Street, Norwalk, Connecticut. Business Office, 1379 East 15th Street, Brooklyn 30, New York. Telephone: DE 6-8880. Subscription rates: U.S.A. and possessions, APO, FPO, Canada and Mexico; one year \$3.00; two years \$5.00; three years \$7.00. Foreign: one year \$4.00; two years \$7.00. Second-class postage paid at Norwalk, Connecticut. Printed in the U.S.A. Entire contents copyright 1961 by Amateur Radio Publishing, Inc. Postmaster: Please send form 3579 to 73 Magazine, 1379 East 15th Street, Brooklyn 30, New York.

... de W2NSD

(never say die)

The cards from the May issue have been coming in quite satisfactorily. They've kept me up to all hours hacking the information requests out for advertisers and toting up the article votes. The addition of the "Message to the editor" to the card this time resulted in a slightly puffed ego from all of the kind words. Some few suggested things they'd like to see in print. It struck me that this might act as a spur to fellows who may have just what these chaps want, but haven't written it up yet. So how about making a note of something you'd particularly like to see in print on the card this month . . . and don't forget to fill in some of the information request blanks.

Some of the items requested this month that stick in my mind are: anything on RTTY, more SSB articles, more VHF construction projects, a converter for the aircraft frequencies from 108-138 mc, how to take good equipment photographs, surplus conversions, etc. One chap wanted a 25 watt 160 meter CW rig to carry him through the next few years of the sunspot cycle. Almost anything transistorized is read avidly, and Nuvistors are still Nu.

April Votes

The card in the April issue just about snowed me under trying to count all the votes. They're still coming in every day, but we have to stop somewhere, and besides, there no longer is any question about which article wins for the month. Here are the votes:

Nuvistor Converter K8BYN	1609
Noise Limiter K5JKX/6	1352
Take Your Pick, Staff	972
Tennessee Indians K2SJN	698
Transistor Modulator KL7DLC	655
Heathkit Twoer W3UZN	489
Modulate Not Crepitate K4ZGM	428
Calibration W4WQT	426
Have Wave Feeders W9HOV	377
Power Meter K8ERV	358
RF Noise Suppression K2TKN	355
Boosting Command Audio K8HDR	307
Big Cannon W6VVZ	297
Write for 73, Staff	272
Automation K5JKX/6	180

When the 14th most popular article in an issue gets 180 votes, I'd say that we're doing pretty well!

Implicit-Explicit

While on my way up to Rochester to give a

talk at the Hamfest (and sell a few subscriptions), I got to mulling over the problem of getting fellows to build equipment and the 73 approach to doing something about it. The more I mulled the more I was aware that my good old New England taciturnity had won out again and that I had said in much too few words what I had intended to communicate way back in the first issue. Bear with me while I elaborate a bit on the general theme.

After leaving my former place of employment I spent a couple weeks kicking myself for not having left a year or two earlier and then decided that the best course of action was to take the bulls horns and put out my own ham magazine. I had been grumbling in my editorials for several years about the decline in home construction, but hadn't figured anything to do about it. Now, with some time for investigation, I started taking a long look at the problem and came up with a theory that seems to be proving correct. A careful inspection of the ham magazines made it obvious to me that *they* were largely responsible for the drop in construction.

A quick riffle through the back issues of ham literature will bring this point home, I believe. I found that there were only a handful of simple construction projects being published each year, and most of these were items for Novices and were of little interest to the bulk of the hams. I noticed that much of the gear being described had obviously been built in a well-equipped lab and had been tuned with lab test equipment that just isn't found in many ham shacks. The very perfection of the gear being described is a psychological stumbling block for the chap who would like to duplicate it.

Looking further in the ham magazines I found that the bulk of them were filled with operating news. It is axiomatic that everyone likes to see his call in print, but when it gets to where this is the major part of our literature then something is wrong. In addition to large segments of the magazines being admittedly devoted to catering to this form of flattery, there are even greater bundles of pages doing the same thing under an assumed name. I had tried, unsuccessfully, to change this course of events in years past, and decided that now was the time to correct this problem. You see, I envisioned special interest columns as devoting their space to a discussion of technical topics, not to an extension of the operating news section of the magazine.

(Turn to page 6)

Ebco

Skysweeper Special

6 METER HORIZON- TALLY POLARIZED ANTENNA FOR "HAM" STATIONS

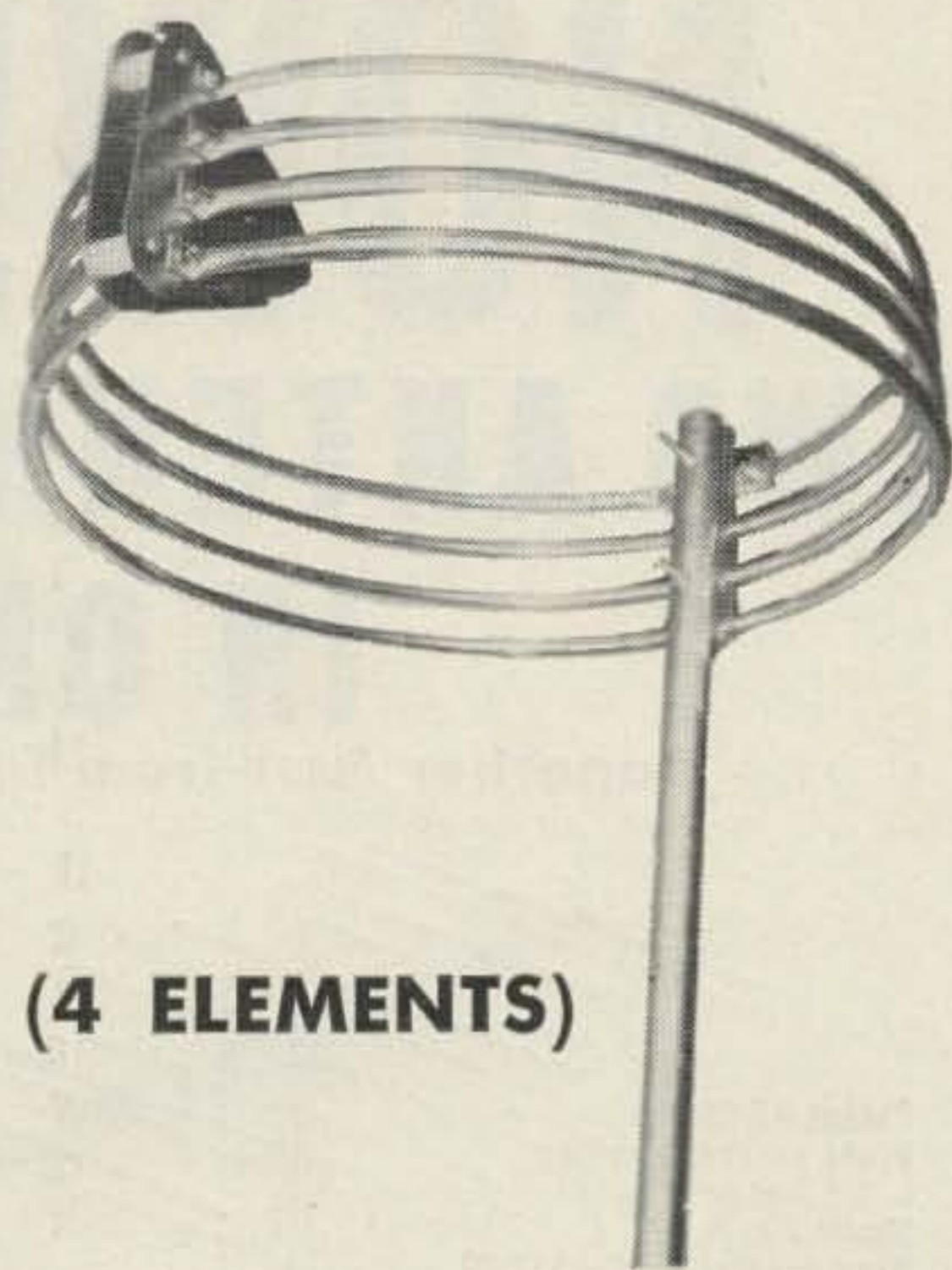

(4 ELEMENTS)

EBCO ASTOUNDS THE EXPERTS—works out of mountain valleys where others could not be heard (Monongahela and Susquehanna Valley VHF Trials).

EBCO OUTPERFORMS THEM ALL—used almost exclusively by Motor City Mobile Club of Detroit and by many others who have "tested them all."

AMAZING low-angle, high-gain performance. Puts the signal right where you want it, with plenty of "Sock!"

200 to 300 miles ground wave on 6 meters with Gonset Communicator—**MOBILE!**

SKYSWEEPER SPECIAL, 4 elements on 6 meters, high gain, perfect low angle radiation, heavy duty aluminum construction with extra duty, high quality polyethylene and teflon insulators\$19.95 amateur net

"NO COMPARISON" reported again and again.

RUGGED construction throughout—can be attached to standard trailer hitch in rear—mounts 6' above rear bumper.

Models also available for 6-and-2 meters and for 11-meter Citizen's Band.

Write for information on special models and adapters for 2- and 3-band operation!

Sold by major amateur dealers throughout the country.

Instructions for coax matching stub included. Or for perfect match without stub, EBCO AUTO-COIL (\$3.95) is now available.



Ebco Manufacturing Co.

30240 CAMPBELL

Box No. 416 Village Station

WARREN, MICH., U.S.A.

Order thru your local dealer, or from EBCO MFG. CO., P. O. Box 416, Village Station, Warren, Michigan, or P. O. Box 895, Los Amigos Station, Downey, California.

Excellent for fixed station, too. (Like a beam pointed in all directions at once!) High gain—no rotator needed.

Neat • Compact • Non-Monstrous Appearance • Corrosion-Resistant • No Maintenance • Built for Life • Unaffected by Moisture • Dimensionally Stable • Non-Breakable Even in Arctic or Tropical Temperatures

Watch future issues of 73 for amazing reports on the EBCO!

Don't miss a minute of mobile fun—order NOW!

You CAN'T be disappointed in an EBCO!

NOW! TWO ANTENNAS IN ONE*

*another *FIRST* from *FINCO*

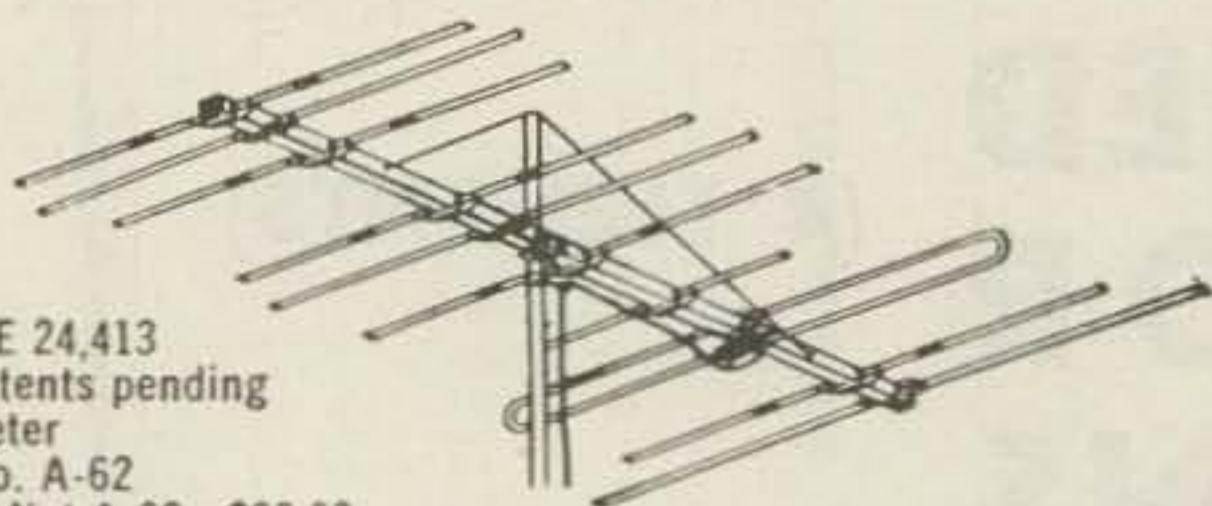

Patent RE 24,413
Other patents pending
6 & 2 Meter
Model No. A-62
Amateur Net A-62 \$33.00
Stacking Kit AS-62 \$2.19

The Only Single Feed Line

**6 & 2 METER
COMBINATION YAGI ANTENNA**

from **FINCO**[®]

- Heavy Duty Square Aluminum Boom, 10 Ft. Long
- All Elements are Sleeve Reinforced And Completely Pre-assembled With "Snap-Out" Lock-Tite Brackets
- Boom Suspension Rods Are Supplied Completely Pre-assembled, Ready To Be Snapped Into Upper End Of Mast

ON 2 METERS:

- 18 Elements
- 1—Folded Dipole Plus Special Phasing Stub
- 1—3 Element Collinear Reflector
- 4—3 Element Collinear Directors

ON 6 METERS:

- Full 4 Elements
- 1—Folded Dipole
- 1—Reflector
- 2—Directors

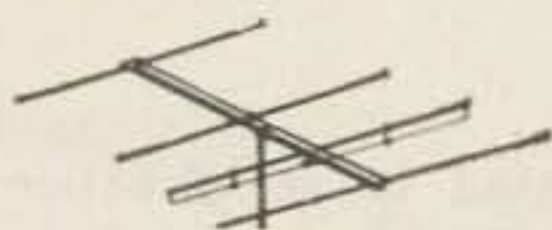

A6-4 6 Meter 4 Element
Amateur Net \$17.16
Stacking Kit AS-6 \$2.19



A2-10 2 Meter 10 Element
Amateur Net \$11.88
Stacking Kit AS-2 \$1.83

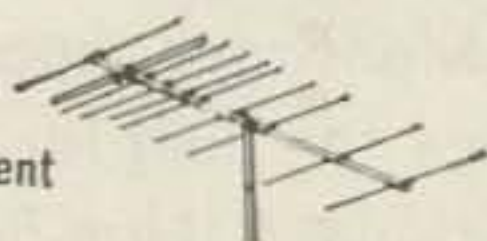

A1 1/4-10 1 1/4 Meter 10 Element
Amateur Net \$11.88
Stacking Kit AS-1 1/4 \$1.26

See Your FINCO Distributor
or write for Catalog 20-226 to:
THE FINNEY COMPANY
Dept. 20, 34 W. Interstate St., Bedford, Ohio

A VHF column could well devote itself to technical topics and continue to be interesting indefinitely without ever mentioning who was working whom and with what rig and antenna. The RTTY column could well continue forever and never exhaust the technical side of this facet of the hobby. Even a DX column could stick to technical topics, with discussions of antennas, low noise pre-amps, antenna switching, feedlines, possible DXpedition sites, etc.

The difficulty with running columns of this nature is that an editor would have to find fellows who are willing to work full time writing them, for they would take many times the effort to prepare that the present columns do. But then, why have columns at all? If something is interesting enough to be printed in a column it can just as well be run as a feature article. And that is what we are doing with 73. The pages of 73 are open to anyone that would like to run a monthly column . . . all you have to do is have enough interesting information and keep sending it in.

Something New

One thing that has bugged me for a long time are the articles that I occasionally have to reject because they are of too limited interest. These may be well worked out conversions of surplus items, modifications of commercial gear, etc. Usually these are long articles and would be of interest to only a small fraction of the readers. I have a solution that should be fine for both author and reader. On these long articles we would publish a short article in 73 describing the equipment or modification and then make the detailed instructions available for \$1.00, half of which would go to the author. The other half would go toward defraying our costs of publishing the article, mailing it and keeping records on the whole operation. This is obviously a loser for us, but it will serve a purpose. And who knows, once we get it started and find out that it is a good idea; we might raise the price just enough to make it break even. If you have any manuscripts that might fit into this category you might consider our proposition.

Subscription Rates

While we do not consider a subscription blank an absolute necessity for starting or renewing your subscription, it may simplify matters for you. We have bound one in his issue so it is not necessary to rip your copy of 73 all to shreds. Rates: \$3 per year; \$5 two years; DX operators \$4 per year. Back issues: 50¢ each. Subscriptions start from current issue only.

the
200V

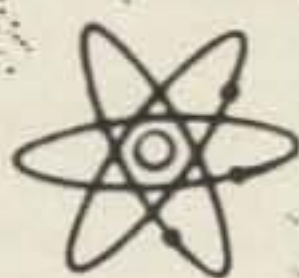

BROAD BAND EXCITER / TRANSMITTER

ONLY ONE TUNING CONTROL - THE VFO

Amateur net . **\$795.00**

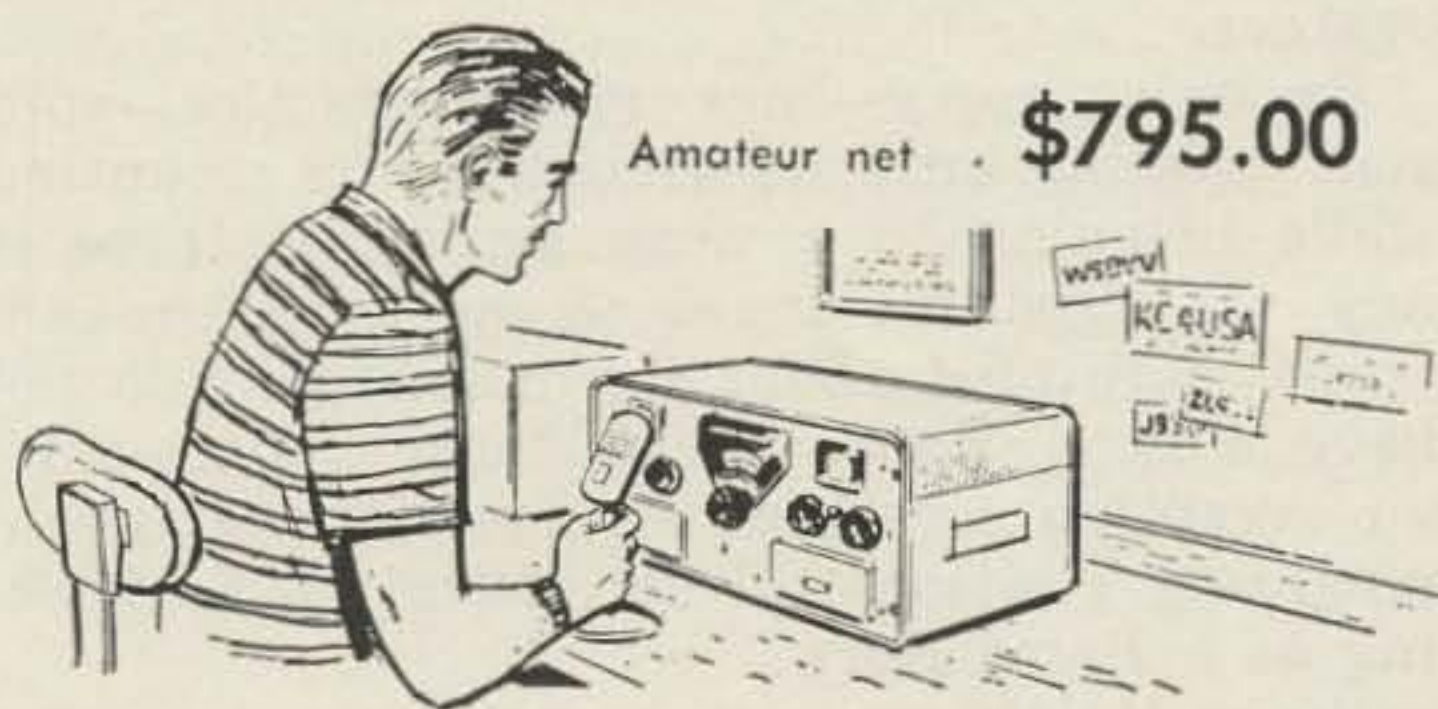

REGARDLESS OF PRICE....

THE 200V IS THE STANDARD OF COMPARISON IN CONSTRUCTION, WORKMANSHIP, EASE OF OPERATION, STABILITY and AUDIO QUALITY.

WRITE FOR NEW BROCHURE

FREQUENCY COVERAGE

- 3.5 - 4.5 MC
- 6.5 - 7.5 MC
- 13.5 - 14.5 MC
- 20.5 - 21.5 MC
- 27.7 - 29.7 MC

YOU DON'T SETTLE FOR "PARTIAL" FREQUENCY COVERAGE WHEN YOU BUY A 200V

POWER INPUT: 200 watts PEP on SSB
175 watts on CW, FSK, PM
100 watts on AM

CHOICE OF: LSB, USB, AM, PM, CW, FSK

- INVERSE AUDIO LIMITER
- PERFECTED AUDIO FILTER
- POWER OUTPUT CONTROL
- SILICON RECTIFIER POWER SUPPLY
- 2" MONITORING SCOPE
- LOAD MISMATCH PROTECTION
- DOUBLE HETERODYNE CIRCUIT
- NEW MIXER CIRCUITS

CARRIER SUPPRESSION: At least 50 DB.
SIDE BAND SUPPRESSION: 50 DB.
CALIBRATION ACCURACY: 1 KC.
UNWANTED MIXER PRODUCTS: Down in excess of 50 DB.

AUDIO RESPONSE: Approx. 200- 3800 Cycles.
OUTPUT inherently matches load impedances of 52 - 72 ohms.

**A
V
A
I
L
A
B
L
E

N
O
W**

Central Electronics, Incorporated

1247 W. BELMONT AVENUE • CHICAGO 13, ILLINOIS



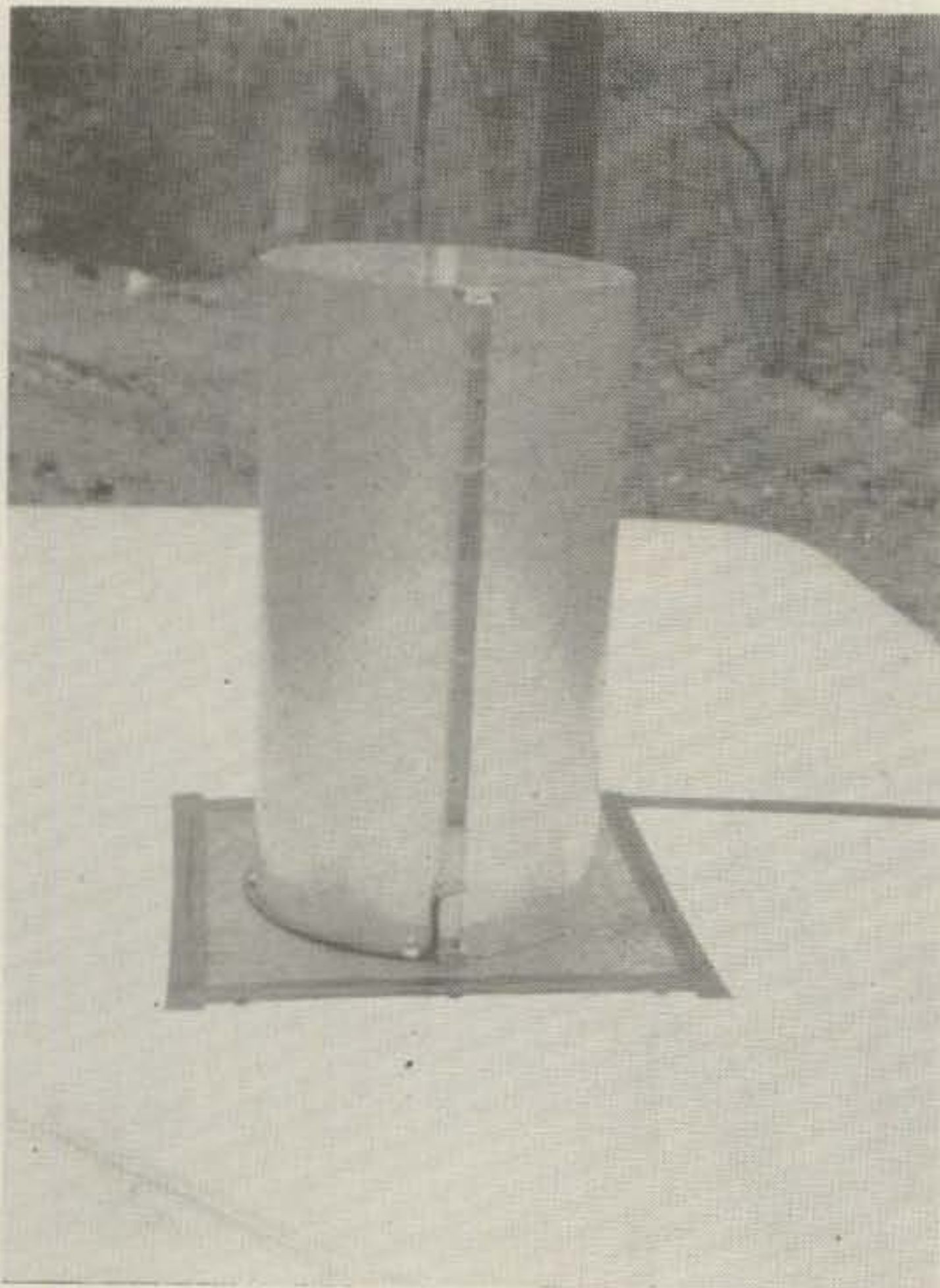

The "Abe Lincoln"

Bill Ashby K2TKN
Box 97
Pluckemin, N. J.

THE second most popular point of discussion, when a group of hams meet, is what form of antenna works best in a restricted space. When a mobile, horizontally polarized solution is required, the theories are many, workable practical answers few. Many years ago the writer, then WØETJ, shook up a few highway travelers by driving all over Missouri, Illinois, Indiana, and Ohio with a pair of 5 element two meter beams, stacked and on a rotor, all mounted on the back bumper of the car. From the ridiculous to the sublime, many wild combinations were used, all good in theory, most poor in actual radiated signal or mechanical monstrosities.

In 1949, I decided the Halo was the best mobile, horizontally polarized compromise—but it had to be designed properly. Most so-called Halo's in use today are actually Ram's Horn antennas. A true Halo is a shortened 8JK flat-top beam, so arranged mechanically that it has end-fire gain in all horizontal directions. Current must be fairly equal in all parts of the radiating portions and 180° out of phase at any two points opposite each other across the circle. Very little energy is radiated up or down; this is why a good Halo works out well in mobile installations, with almost 3db gain over a dipole's best direction.

Few people understand the simple principles of why a Halo works, as evidenced by many commercial versions copied from bad information they have gleaned from VHF articles and columns of other amateur publications. Taking a dipole, folded or otherwise, and bending it into a circle, does not make a Halo an-

tenna. The result is non-directional, in fact it doesn't radiate well in any direction except up when installed near a large chunk of metal. A good 2 meter Halo is small, not over 10 inches in diameter, better if only 8". To resonate to frequency, of course, capacitor loading of the open ends is required, a lot of capacity! Thus, current is almost uniform at any point around the circle, end fire directivity across the circle becomes very evident, and radiation angle is low, very little up or down, most out where it does the most good. Radiation is practically uniform thru the full 360 degrees.

Enough theory—how about practice—spin your existing antenna around on its mounting while listening to a weak signal; if there is any variation in signal strength as the antenna is rotated about its mount, you do not have a good Halo, "picket-fence" phase-shift on reception has been evident, and physical mounting position will be critical; it is working as a Rams Horn.

Since Halo's are not easy to get operating properly in actual practice, further investigation seemed to me to be in order. An antenna type used in commercial FM Broadcasting for many years looked promising—it is the Slotted-Pylon. This antenna is a vertical pipe, 1/10 wave length in diameter, approximately 3/4 wave length high, with uniform horizontal coverage. Of much interest is the fact that both top and bottom of the cylinder are points of zero rf.

A full Pylon-Slot was constructed, mounted on the rear bumper of the car, and then the fun began. On two meters the sizes work out

as follows—10 inches in diameter, 60 inches high, with a 1 inch slot running vertically from top to bottom. The ends of the slot are shorted (the circle is complete), the top and bottom of the main cylinder can be left open or covered with metal with no difference noted in performance.

This antenna was the center of attraction at the Syracuse VHF Roundup in 1959. It was a stand-out in a parking lot famous for real "out" mobile VHF installations. Many XYL's left thanking heaven that their OM had only installed a sensible Halo (?) on their family heap. This antenna really pokes out a signal, approx 6db over a dipole, but a state cop can spot you a mile away—Tony, VE3DIR, almost ran his station wagon off the road when he saw me come over a hill, stove-pipe waving in the breeze!

After cleaning out all country telephone lines in the area, and leaving a few dents in low bridges, I decided to see if the monster

couldn't be reduced in size a bit, without losing too much signal. The "Abe Lincoln" is the result.

This is shortened bottom half of a Pylon-Slot. It is mounted flush in the middle of the roof of the car, secured with wide masking tape, which is renewed occasionally. It can be fabricated out of any conducting material. A word of warning—certain sized holes create a siren-effect at various speeds—the unit pictured has a plexi-glass top, not to keep the rain out, but to keep it from becoming a very loud fog horn at high speeds. Size—10 inch diameter, height 20 inches, slot $\frac{1}{2}$ inch wide, and as mentioned, the slot and top are filled with $\frac{1}{4}$ " plexi-glass. There are 2 x 2 inch tuning tabs across the slot at the top. This keeps the height down to a reasonable level.

Tune up procedure is very simple—bring a grid-dipper coil up close to the shorted bottom of the slot. A good dip will be evident at the resonate frequency—adjust the spacing

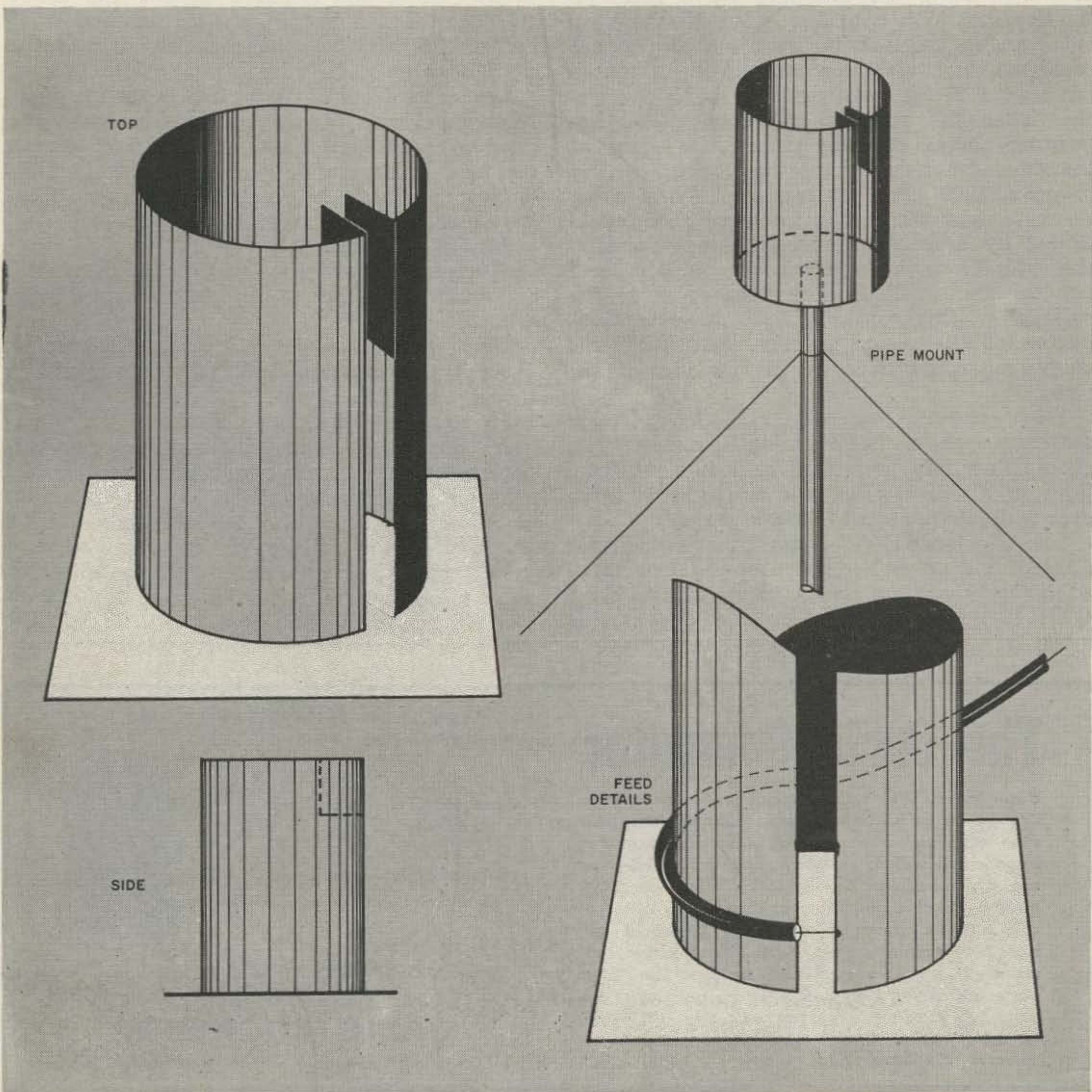



of the tuning tabs for resonance at 146 mc. Attach 52 ohm co-ax—the shield to one side of the slot, the center conductor to the other side—start about 2 inches from the bottom. While checking the standing wave ratio on the feedline with a bridge, move the taps up or down on the slot for best match. Do not re-adjust the tuning tabs, attempting to match the line, for this gets you into a vicious circle. When the antenna is resonant, the impedance across the slot is resistive—zero at the shorted bottom, increasing almost linearly to prox. 1000 ohms at the top. When using co-ax to feed the slot, a balanced feed is obtained by dressing the co-ax snugly around the cylinder to the side opposite the slot, and bonding the shield braid of the co-ax to the cylinder at this point. In fact, the outer conductor of the co-ax may be bonded all the way around the side of the cylinder if desired.

When properly matched, check the radiation pattern with a field strength meter. You should find only horizontal radiation, uniform gain in all directions, and approx 4 db gain over a dipole mounted in the clear.

The shortened Half Pylon Slot is ideal for 2 meter and up mobile operation, and mounted on a mast, well up in the clear, at the home QTH is a real pleasure to use. A beam is

fine for DX, but is a pain in the neck for local operation. You just don't realize how many people are on these VHF bands until you have used a good horizontal non-directional antenna feeding a low-noise converter.

This antenna can be mounted many ways. The entire bottom, closed or open, is at zero rf potential as is the back area up the cylinder opposite the slot. If you fabricate the bottom plate of the cylinder of fairly heavy gauge metal, then a pipe flange or a TV mast clamp may be attached to the center, so that the Abe Lincoln may be top mounted on a pipe. The feed line may be brought down thru the pipe if desired; it can be installed inside the cylinder, slot, etc., just as described for outside. The Slotted Pylon antenna can be mounted with "U" bolts to the side of a mast or tower with some effect on the radiation pattern. The side away from the slot is placed next to the tower leg or mast. If a null in radiated pattern occurs, move the antenna around the tower to place the null in the least used direction.

The full slot version may be stacked for additional gain. Procure a pipe of the desired diameter and cut slots vertically up one side, one wavelength apart between centers, and feed all slots in phase. A 1926 mc. beacon antenna is currently being designed, 13 slots high, material is 1 5/8 inch 52 ohm co-ax. Tentative data, in excess of 15 db gain—

Height—11 feet.

Horizontal directivity— ± 1 db 360 degrees.

Vertical directivity—approx. 15 degree beam width.

Feed Impedance—52 resistive at 1296 mc.

Apply leverage to W2NSD if full info is desired on this antenna.

In summary, the Pylon Slot and the shortened version fill a need in amateur communications systems. Many variations are possible, why not see what it will do for you, after all, a 20 meter unit is only 16 feet high and 6.4 ft. in diameter and set-up in your backyard would give the neighbors something different to discuss—as well as making you top dog in a WAC round table on SSB. . . . K2TKN

The Curta Computer

This, the world's smallest computer, is made in a tiny factory up in the mountains of Liechtenstein. Almost unknown in this country, this is an incredible invention. It will do everything that a big desk type can do, though it is only 2" in diameter (2 1/2" for the "big" Curta). If you have to do a lot of calculating in your business and you would like something smaller or less expensive than the Monroe or Friden, then send for literature. The "big" Curta has eleven keys and will give an answer accurate to 15 digits. You can multiply an 11 digit number times an 8 digit number and get your answer to 15 places. Adds, subtracts, multiplies, di-

vides quickly and accurately. Takes only a few minutes to learn how to use. Rugged.

Curta Model I—(11 places
for result) \$125.00

Curta Model II—(15 places
for result) \$165.00



Further Information?

Write

RADIO BOOKSHOP

1379 East 15th Street

Brooklyn 30, N. Y.

To the hundreds
of Hams who have
taken the time
to write, we at
EICO can only
say . . .

FROM THE BOTTOM OF OUR HEARTS, THANK YOU

We promise to continue
to do all in our power
to merit your approval.

Milton Stanley
3909 High View Rd.
E. Peoria, Illinois

Electronic Instrument Co., Inc.
3300 Northern Blvd.
Long Island City 1, N. Y.

Dear Sir:

When I saw your Model 720 Transmitter on display, it looked so good that I decided to purchase a 720 kit. I put it together in five evenings. The instruction book is so well written that any beginner can build this kit with no trouble at all. When I put the 720 on the air for the first time, I called CQ and a station in Munising, Mich. answered me and gave me a 599 report. In two months I had worked 37 states with a single wire antenna about fifteen feet off the ground. All stations worked gave me a good report. I was so pleased that I purchased an EICO Model 730 Modulator. Results were equally good. I have worked 44 states and Canada on phone with the 720 and 730. All reports I get are very good. The clipping level control and the over modulation indicator helps make the EICO 730 Modulator the best buy for the money and I personally believe the EICO 720 Transmitter is the best 90-watt rig on the market. The EICO 720 and 730 together make an all around rig that is hard to beat. I am so well pleased with the quality of EICO kits that I am looking forward to building more of your products. I highly recommend EICO kits to beginners as well as the old timers.

Sincerely,

Milton Stanley
MILTON STANLEY, K9VJH

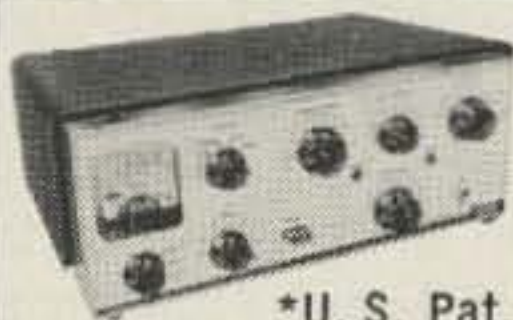

**90-WATT CW
TRANSMITTER***
#720
Kit \$79.95
Wired \$119.95

*U. S. Pat. No. D-184,776
"Top quality" — ELECTRONIC
KITS GUIDE. Ideal for veteran or
novice. 90W CW, 65W external
plate modulation. 80 through 10
meters.



**NEW!
60-WATT CW
TRANSMITTER**
#723
Kit \$49.95
Wired \$79.95

Ideal for novice or advanced ham
needing low-power, stand-by rig.
60W CW, 50W external plate mod-
ulation. 80 through 10 meters.



**CITIZENS
BAND
TRANSCIVERS**

Single and
Multi Channel Models Available.
From Kit \$59.95 Wired \$89.95



**HIGH-LEVEL
UNIVERSAL
MODULATOR-
DRIVER**
#730

Kit \$49.95 Wired \$79.95
Delivers 50W undistorted audio.
Modulates transmitters having
RF inputs up to 100W. Unique
over-modulation indicator. Cover
E-5 \$4.50.



**GRID
DIP
METER**
#710

Kit \$29.95 Wired \$49.95
Includes complete set of coils
for full band coverage. Continu-
ous coverage 400 kc to 250 mc.
500 ua meter.



**PEAK-TO-PEAK
VTVM #232
& *UNI-PROBE®**
Kit \$29.95
Wired \$49.95

VACUUM TUBE VOLTMETER #221
Kit \$25.95 Wired \$39.95

*U. S. Pat. No. 2,790,051



**COLOR &
MONO DC-5MC
LAB & TV 5"
OSCILLOSCOPE**
#460
Wired \$129.50
Kit \$79.95

5" PUSH-PULL OSCILLOSCOPE
#425 Kit \$44.95 Wired \$79.95



**DYNAMIC
CONDUCTANCE
TUBE
& TRANSISTOR
TESTER #666**

Kit \$69.95 Wired \$109.95
TUBE TESTER #625
Kit \$34.95 Wired \$49.95



**RF SIGNAL
GENERATOR
#324
(150kc-435mc)**
Kit \$26.95
Wired \$39.95

**TV-FM SWEEP GENERATOR
& MARKER #368**
Kit \$69.95 Wired \$119.95

EICO®

3300 Northern Blvd.
Long Island City 1, N. Y.

EICO, 3300 N. Blvd., L.I.C. 1, N. Y.

Send free Catalog & name of
neighborhood distributor.
 Send free "Short Course for
Novice License." Send
36-page **STEREO HI-FI GUIDE:**
25c enclosed for postage
& handling.

Name

Address

City

Zone

State

Add 5% in the West.

73F

ENGINEERS: Excellent career opportunities in creative electronics design. Write to the Chief Engineer.

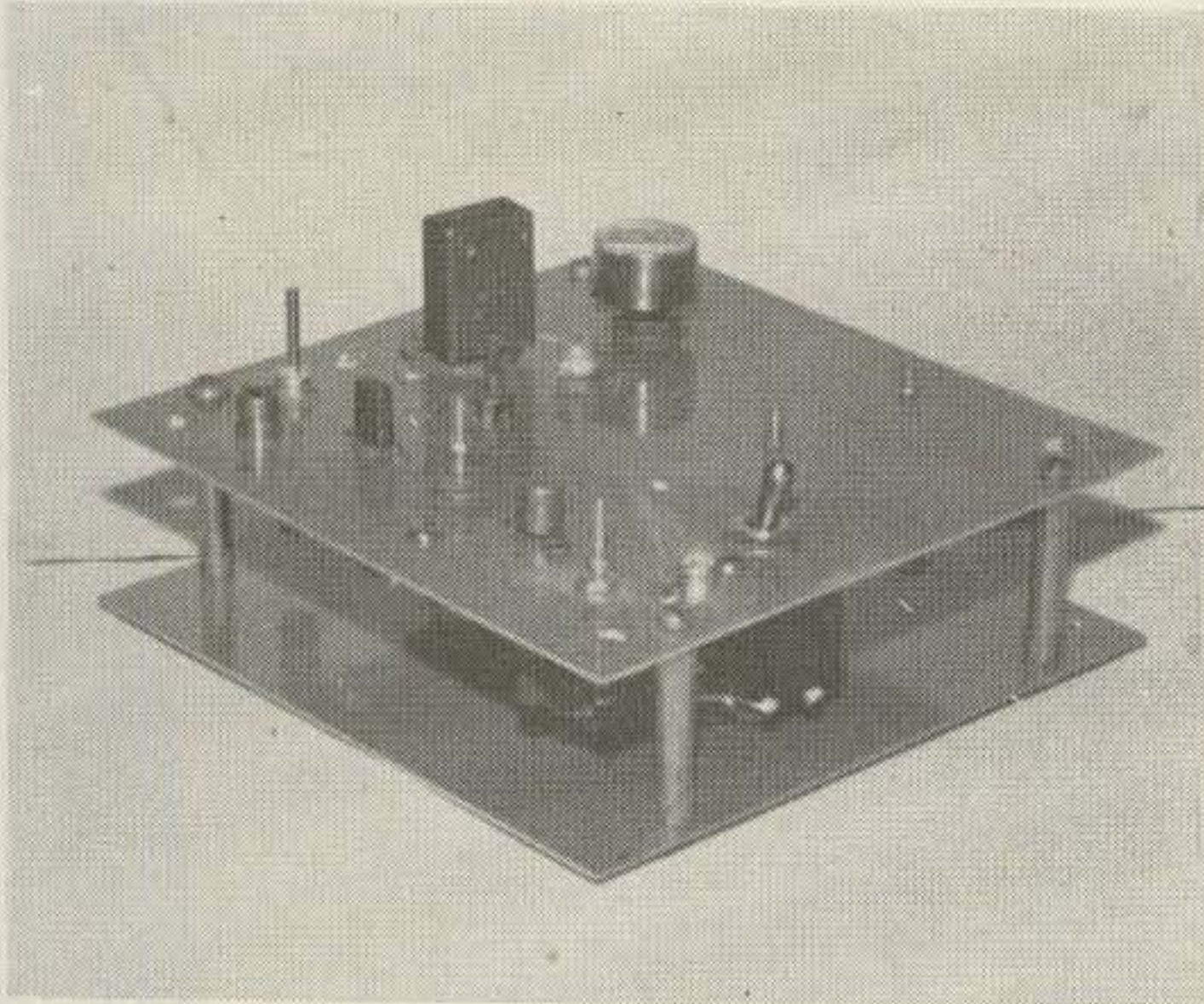

H. W. Johnson WA6DZL
 1115 Molinar Ave.
 La Puente, Calif.

75 Meter Transistorized Converter

I'VE tried several varieties of tube type converters for 75 meters, but none of them lived up to my expectations. Then I built a three transistor 75 meter mobile converter which has outperformed all of the previous tube types. Since it requires no B+ or filament voltage from the car radio it can be used with any existing auto receiver. It is presently installed in my VW and is performing excellently. The sensitivity is very good and my noise limiter has rarely had to be used.

Several types of transistors were tried. I found that though other (3 lead types) P.N.P. rf transistors worked well in the rf stage, they are not as satisfactory since there is much higher gain available with the drift

types, such as the 2N247. The CK768 mixer, chosen mainly because of its low cost, worked well. Several types of transistors were tried in the oscillator and all worked quite well, including the 2N404, chosen here because of its low cost.

Wiring is not critical so long as leads are kept short. The use of sockets for the transistors is highly recommended. The oscillator was easily brought into oscillation and was first adjusted using a wave absorption meter and lastly, while installed in the car. RF and mixer coils were also peaked in the auto to approximately the center of the band (3.9 mc). An NE-2 neon light was installed across the input tank to afford some degree of protec-

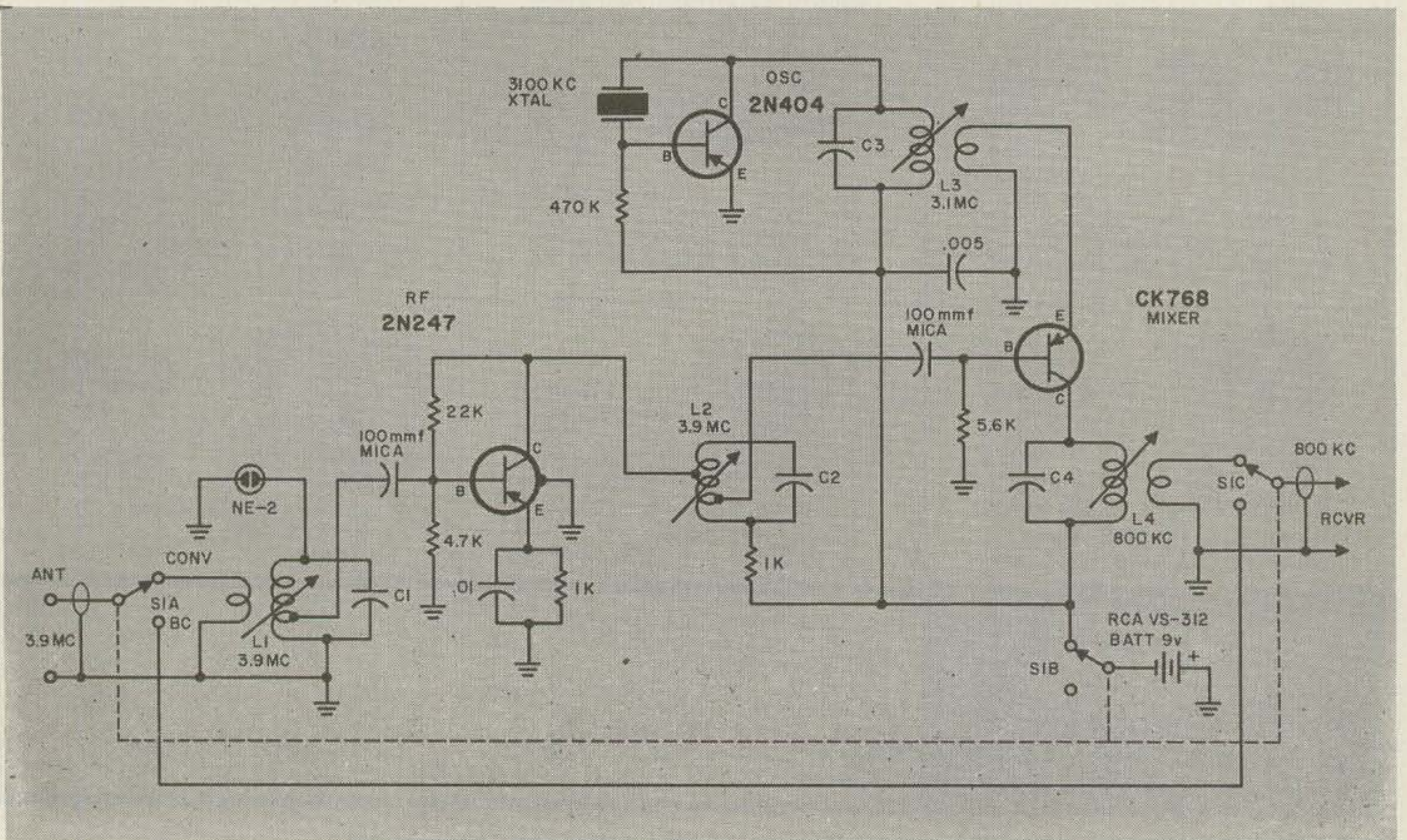

tion against too much transmitter rf injuring the 2N247. A zener diode would of course provide even better protection. The crystal frequency was chosen only because I wanted to tune the 3800 to 4000 kc portion between 700 and 900 kc. Any other crystal frequency can be used to create the desired output frequency.

For the cost conscious, a comparison of prices taken from a leading catalogue house showed the three transistors to be considerably less in cost than suitable tube counterparts.

All in all this converter has been a most rewarding project.

Parts List

Crystal—Approximately 3100 kc (or from 2850 to 3200 kc).

C1 thru C3—Chosen to cause the coils to grid dip to the desired frequency.

C1-3—All were between 50 and 90 mmfd.

C4—360 mmfd mica or equiv.

L1—Wound on $\frac{1}{4}$ " diameter slug tuned forms. No. 30 enamel wire. Approximately 40 or so turns. Link is 4 or 5 turns close wound over cold end. Tap is $\frac{1}{4}$ of the total turns up from the cold end. Grid dip to frequency.

L2—Same as L1 except, it has no link. Taps are $\frac{1}{2}$ and $\frac{1}{4}$ of the total turns, counted from the cold end.

L3—72 turns No. 34 enamel wire on a $\frac{1}{2}$ " dia. slug tuned form. Link is 5 turns on cold end.

L4—150 turns of No. 30 enamel wire on a $\frac{1}{4}$ " slug tuned form. Winding length was approximately 1 inch. Close wound in layer fashion. Link is approximately 8 or 10 turns close wound on the cold end.

L4—Alternate Miller—4514 with a 10 turn link wound on the cold end.

All tuned circuits were grid dipped. All of the wire was close wound on the forms. All capacitors C1 thru C4 should be mica or equiv.

Whipping Things Up

This is directed to you "mobileers." When you make a mobile installation, has it occurred to you that if the antenna (rear bumper mounted as most are) is on the *RIGHT* hand side of the car (viewed from the rear), you've got a better than fifty percent chance of trimming tree limbs, scaring old people and knocking off hats than if it were mounted on the *LEFT* hand end of the bumper?

That's right; mount the mobile antenna on the *LEFT* hand side of the car and you've got a clear area . . . right down the center stripe . . . without the possibility of lawsuit for scraping things and stuff which may overhang or come precariously near the edge of the *OUTSIDE* traffic lane!

More than that, you'll probably require a lot less maintenance than a *RIGHT* hand mounted (from the rear) antenna will call for. Give it a thought, Bud!

. . . W7OE

DESIGN

STRENGTH

DEPENDABILITY

THREE REASONS WHY YOUR BEST BUY IS...

E-Z WAY
Satellite "60"

E-Z WAY AERO-DYNAMIC design decreases wind load and provides telescoping action that permits raising and lowering of tower sections. **CRANK UP TO 60 FEET, DOWN TO 25 FEET and TILTS OVER FOR ACCESS TO ROTOR OR BEAM.**

STRENGTH is built-in to every E-Z Way Tower...Heavy wall steel tubing legs, continuous diagonal bracing of solid steel rod and electrically welded throughout...no loose bolts or nuts here. E-Z Way design and strength are your assurance of **DEPENDABILITY** that you can count on year after year. See your nearest distributor today or write for free literature.

The **SATELLITE**

Model RBX-60-3P (Painted)	\$335.00
Model RBX-60-3G (Galvanized)	\$410.00

MOUNTING KITS:

GPK X60-3 (Ground Post)	\$125.00
BAK X (Wall Bracket)	\$17.00

Freight Prepaid anywhere in (48) U.S.A.

E-Z WAY **LOWMOT**
INC.

P. O. BOX 5767 TAMPA 5, FLA.

Precise Capacity Measurements

You can do it too

Captain John L. Reinartz USNR 'Ret', K6BJ
220 Mar Vista Drive
Aptos, California

To be able to make a capacity measurement down to a fraction of a micro-microfarad in the range from 1 mmfd to 300 mmfd is considered quite an achievement especially if you use equipment that most amateurs have in their hamshack. The least General Radio wants for such a bridge is \$360.00 plus the cost of a number of accessories that may cost as much again.

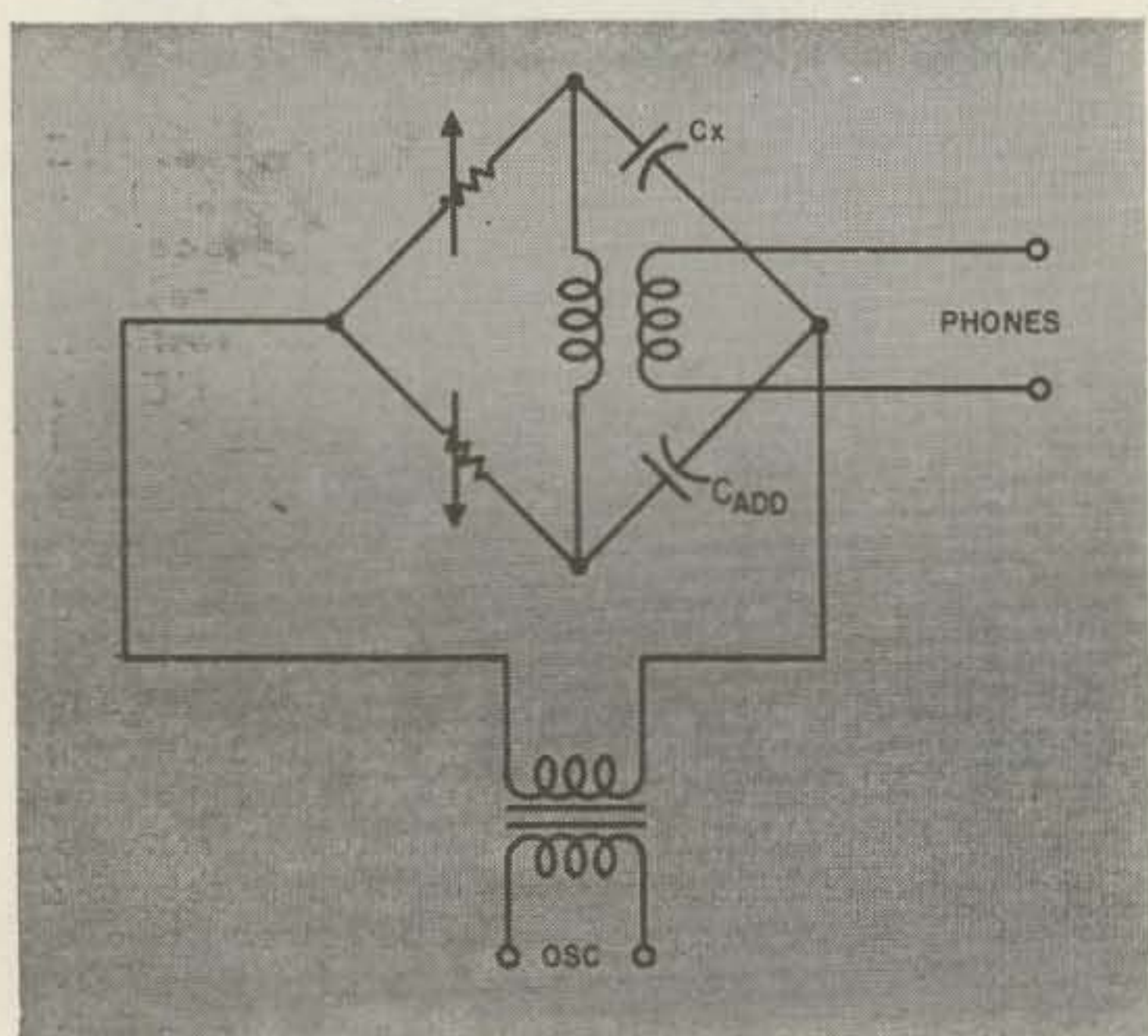

Fig. 1

The classic bridge that is fundamental in most commercial bridges is as shown in Fig. 1. Many refinements are built into this fundamental design when used for precision measurements, such as shielding of the standard condenser and the various other components including an output transformer to which earphones are connected. The trouble is that you have to go about buying at least the calibrated standard condenser. Even after you have it installed in your bridge you are no longer sure that the calibration has been maintained.

To overcome these problems and to be able to use a good garden variety of variable condenser as the standard, do away with the need for a 1000 cycle oscillator and the earphones, be able to measure to plus or minus 1 or 2 tenths mmfd, have no problem when connecting into the bridge because of lead capacity troubles and do this to the full extent of the capacity of the standard used, was the goal I set myself and was able to attain. The final circuit is shown in Fig. 2.

Let us start with a National Velvet Vernier Dial. The dial itself reads from 0 to 100 and

the vernier gives us 1000 divisions. If we use a good broadcast receiver 350 mmfd straight line capacity condenser, and use it over that portion between 10 and 90 divisions on the National dial, we have about 300 mmfd that are useful to us spread over 800 divisions.

We balance the 300 mmfd with a fixed capacitor of a like value and thereafter forget it. All measurements are made by connecting the unknown condenser across the standard condenser and rotating the National dial toward a lesser value until we have again come to the original balance. The value of capacitance we reduced the standard to, will be the value of the unknown condenser. In the case just outlined, you will be able to read to plus or minus 0.2 mmfd, be it for a 10 mmfd or 300 mmfd condenser.

How do we know what the standard condenser calibration is? We go about it this way; let us suppose that we have an initial balance with the National dial reading just 90 divisions. We obtain a small fixed capacitor of say 100 mmfd and have it checked at some lab to a fraction of a mmfd. Let's say it reads exactly 98.6 mmfd. Obviously the original

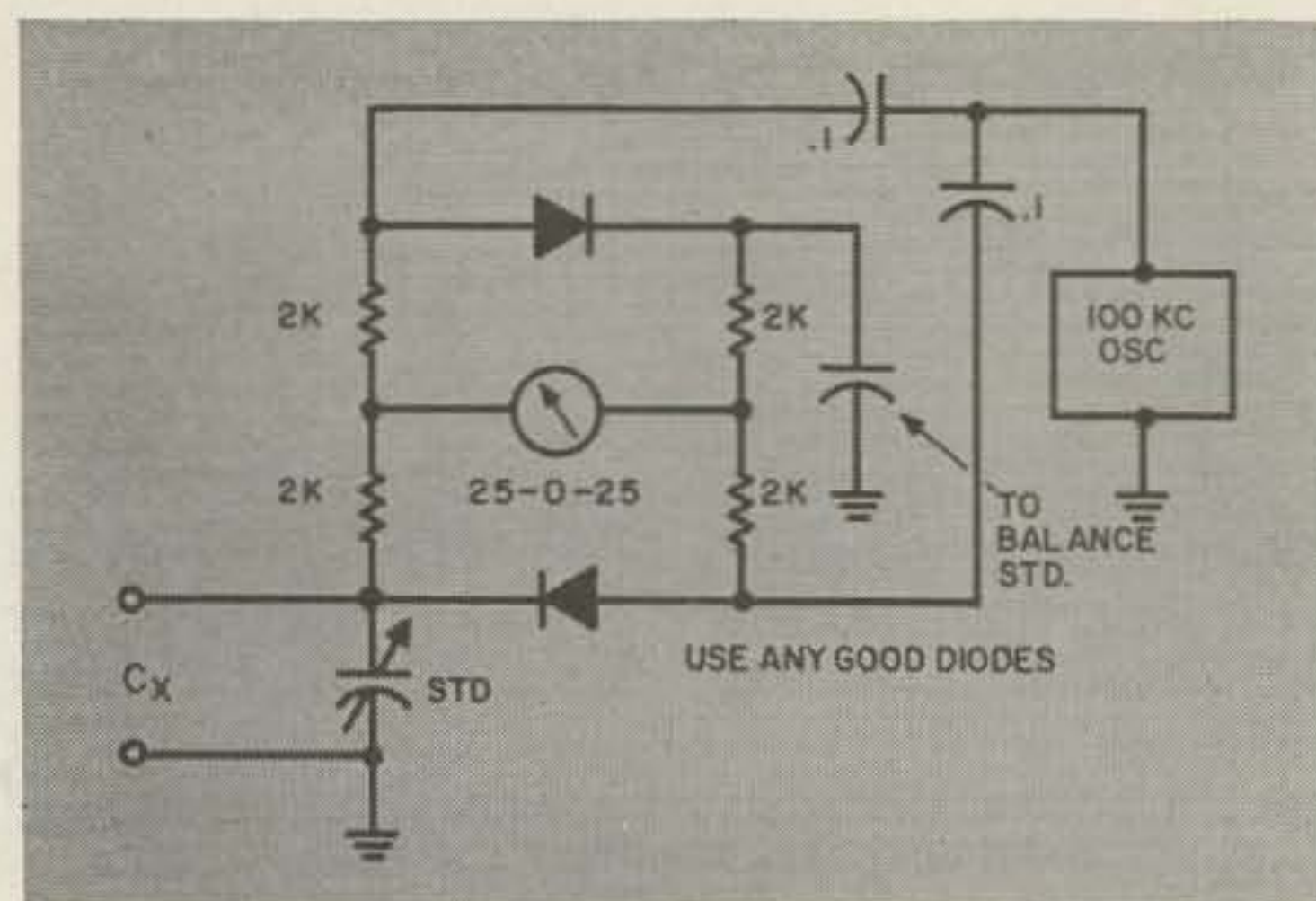

Fig. 2

balance is restored when the standard condenser is reduced by that same amount. If the dial and vernier read 57.1 the standard has a value of 3 mmfd per division and therefore we can read to 0.3 mmfd or plus or minus 0.15 mmfd. Having checked quite a number of straight line capacity condensers, these were all found to be remarkably consistent. Those condensers with ball bearings were of course the best.

100 kilocycles is the frequency used to actuate the bridge. A simple driver is shown in

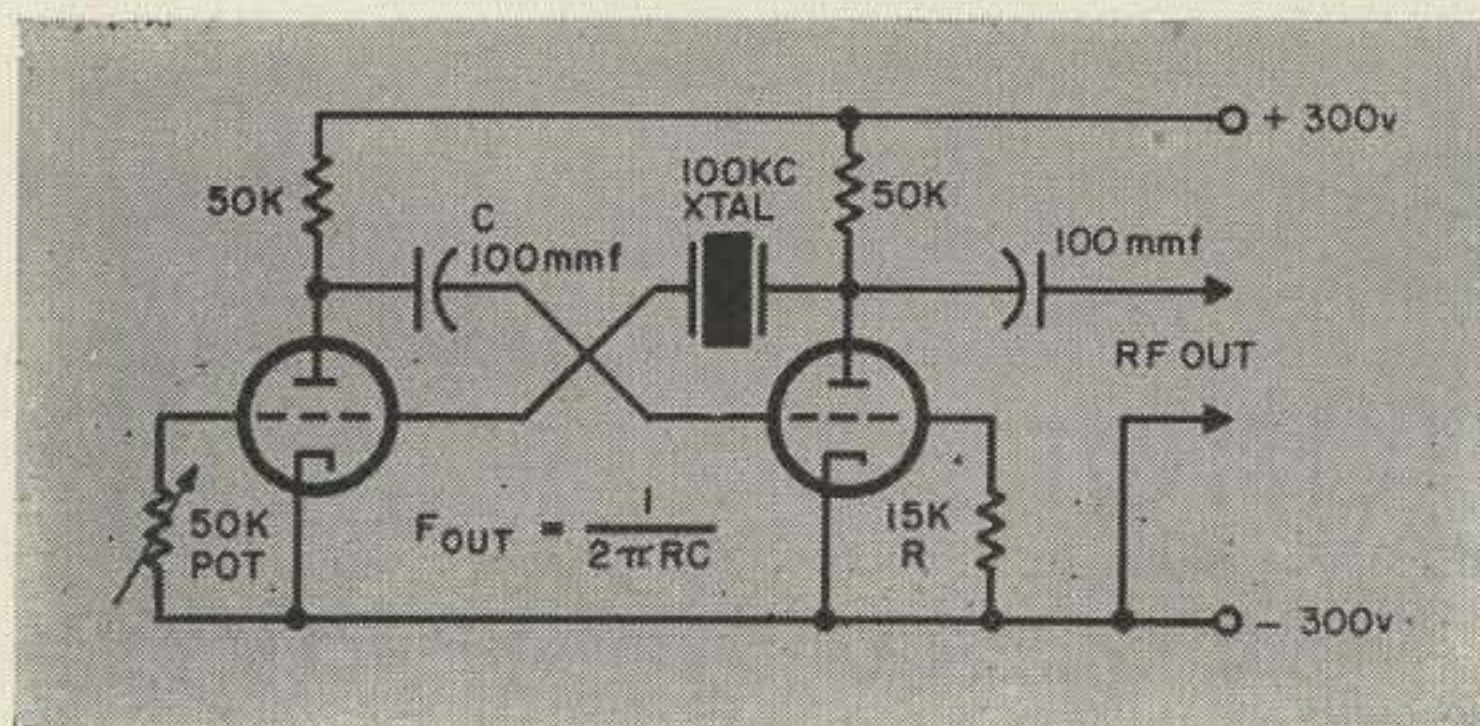

Fig. 3

Fig. 3. It is a simple multivibrator circuit and may be a free running type or it may be crystal controlled. If you have one of the old style 1-inch square crystals you will find that no matter what its frequency is as the fundamental frequency, it will also because of the 1-inch dimension operate at close to 100 kc in a multivibrator circuit. This will hold the frequency quite constant and will result in a stability that will hold for hours at a time.

The resistors are 1 watt rating and four as near in value as can be obtained should be used. The meter is a 25-0-25 micro-ammeter. If you are good at such things, bend the needle edgewise for greater ease of reading the same point at zero. Those who have a L&N Students galvanometer should use it. The accuracy of the reading will be improved due to the suspension type of movement as against the pivot type in the first mentioned meter.

Whenever a condenser needs to be measured and leads several inches long have to be used, these leads are first connected to the standard and are so adjusted that they will not be changed in configuration when attached to the unknown condenser. The lead capacity can be read from the change necessary to the standard reading and the new reading is then the one used to subtract the final reading from when the unknown has been connected and a balance has been obtained. Suppose the normal balance is always 94 div. on the dial. With leads connected a new balance is obtained at 89 div., and with the unknown connected it is 50 divisions. Since in our case the standard has a value of 3 mmfd per division, we find that 89 minus 50 times 3 is the capacity value of the unknown and in this case is 117 mmfd. In this manner any lead value is obviated.

If known values of fixed capacities are added to the balance condenser, the range of the device can be extended as desired. The known additional value is then added to the value obtained from the dial reading.

If that part about having a lab check out your 100 mmfd condenser has you stumped then perhaps we can make a deal. I'll test the value of any 100 mmfd postage-stamp size fixed condenser for anyone that sends me a self-addressed stamped envelope and 25¢ along with the condenser. I am using a General Radio type 722 Precision Condenser in the circuit, so I can give good precision. . . K6BJ



W2RID

GET THE MOST OUT OF YOUR HAM STATION

IMPEDANCE MATCHING by Alexander Schure, Ph.D., Covers impedance matching in electrical and electronic circuitry. Provides detailed information on how to obtain maximum power transfer between any type of generator and load. Dealing initially with maximum power transfer in d-c circuits, the text covers inductance-capacitance relationships, vector notation and the j operator. Impedance matching devices, their application at audio and radio frequencies and in transistor circuits are covered. #166-23, \$2.90.

SHORTWAVE PROPAGATION by Stanley Leinwold (Radio Frequency & Propagation Mgr.—Radio Free Europe). Of special interest to those concerned with radiocommunications. This review in QST (May 1960) sums up the book's vital interest to all amateurs:

"... written at just the right level for the amateur interested in ionospheric propagation There is ... background material—necessary for an understanding of the subject—on the ionosphere, on radio waves, on sunspots and the sunspot cycle, all treated in language that is easy to follow.

Of special interest to QST readers are chapters on amateur contributions to knowledge of wave propagation and a forecast—advanced with admitted caution!—of probable amateur-band conditions during the coming sunspot cycle. Throughout the book the reader is introduced to various interesting aspects of propagation: one-way skip, for example, scatter, meteors, auroral effects—all the things that hams continually encounter in everyday operation. It would be hard to find a question about propagation in the 3-30 Mc. region—at least the type of question that an amateur would ask—that isn't covered somewhere in this book, even if only (of necessity) by the statement that the answer hasn't yet been discovered." #231, \$3.90.

RIDER GLOBAL TIME CONVERSION SIMPLIFIER by Lt. Col. John G. Daiger (Ret'd). No matter where you are located you can tell at a glance what time it is anywhere in the world with ease. It lists small towns and large cities around the world; large cities and small towns in the United States. It is color-keyed to tell you immediately the correct day. Corrects for areas that have Daylight Saving Time. Has conversion tables for those who use 24-hour calculated system. Colorful chart and map makes it usable to anyone. #238, \$1.

HOW TO USE GRID-DIP OSCILLATORS by Rufus P. Turner K6AI. The first book ever devoted entirely to grid-dip oscillators tells you how to construct and use this very versatile instrument with best possible results. It is applicable to all kinds of radio receivers and transmitters, also to television receivers. The grid-dip oscillator is a troubleshooting device—an adjusting device—a frequency measuring device—applicable to circuits and components in circuits—to antennas; also a signal source of variable frequency. #245, \$2.50.

GET YOUR COMMERCIAL TICKET EASIER WITH ...

RADIO OPERATOR'S LICENSE Q AND A MANUAL

by M. Kaufman

Now available 6th edition up to the minute

The BEST book for FCC License Preparation Covers Elements 1 thru 8.

The only book with complete discussion of answers to every technical question in the FCC Study Guide. Makes it very easy to answer multiple choice questions. #130, cloth, \$7.10

Available at your electronics parts distributor, or order direct



6th EDITION



JOHN F. RIDER PUBLISHER INC.
116 West 14th Street, New York 11, N. Y.
Canada: Chas. W. Pointon, Ltd.,
66 Racine Rd., Rexdale, Ont

Propagation

David A. Brown, K2IGY

LAST month in Part I, I covered the Sunspot Cycle and gave a prediction of smoothed numbers for the remainder of the cycle which I think will have its minimum by June 1964. Part II is going to cover the different variations in MUF by presenting a circuit analysis of the path New York to England along with a SPECIAL PROPAGATION CHART for the coming Winter season, 1961.

The MUF (Maximum Usable Frequency) is the highest frequency that will propagate at a given time between two points of communication, and any frequency higher than the MUF will not reach the other end of the circuit. Frequencies below the MUF (especially those lower by a factor of 2 or more) require an excessive amount of power to give satisfactory signal to noise ratios. The MUF for any given circuit varies with the time of day, season of the year and with the Sunspot Cycle.

HBF is the 40 meter band. As soon as the Sun rises however, the MUF rises sharply to a maximum following the zenith angle of the Sun and then falls back down again as the Sun gets lower in the sky. Notice how the HBF follows this curve. It is this plot of the HBF that appears each month in the Propagation Chart for each of 42 different paths. What is important to note is that the MUF and HBF varies with the rotation of the Earth on its axis and with the angle of the Sun in the sky, and that moving from one HBF to another is a jump by a factor of two which means that the HBF for the time given is the best frequency that we can use for hamming.

Besides the daily variation in MUF there are Seasonal variations and these are shown in Fig. 2 and Fig. 3. Here we see that the diurnal variations are different for each month of the year. First, notice that (Fig. 2) the Sunspot number is decreasing as the maximum value of MUF for each month decreases as we go from Winter to Summer. Next in Fig. 3 we

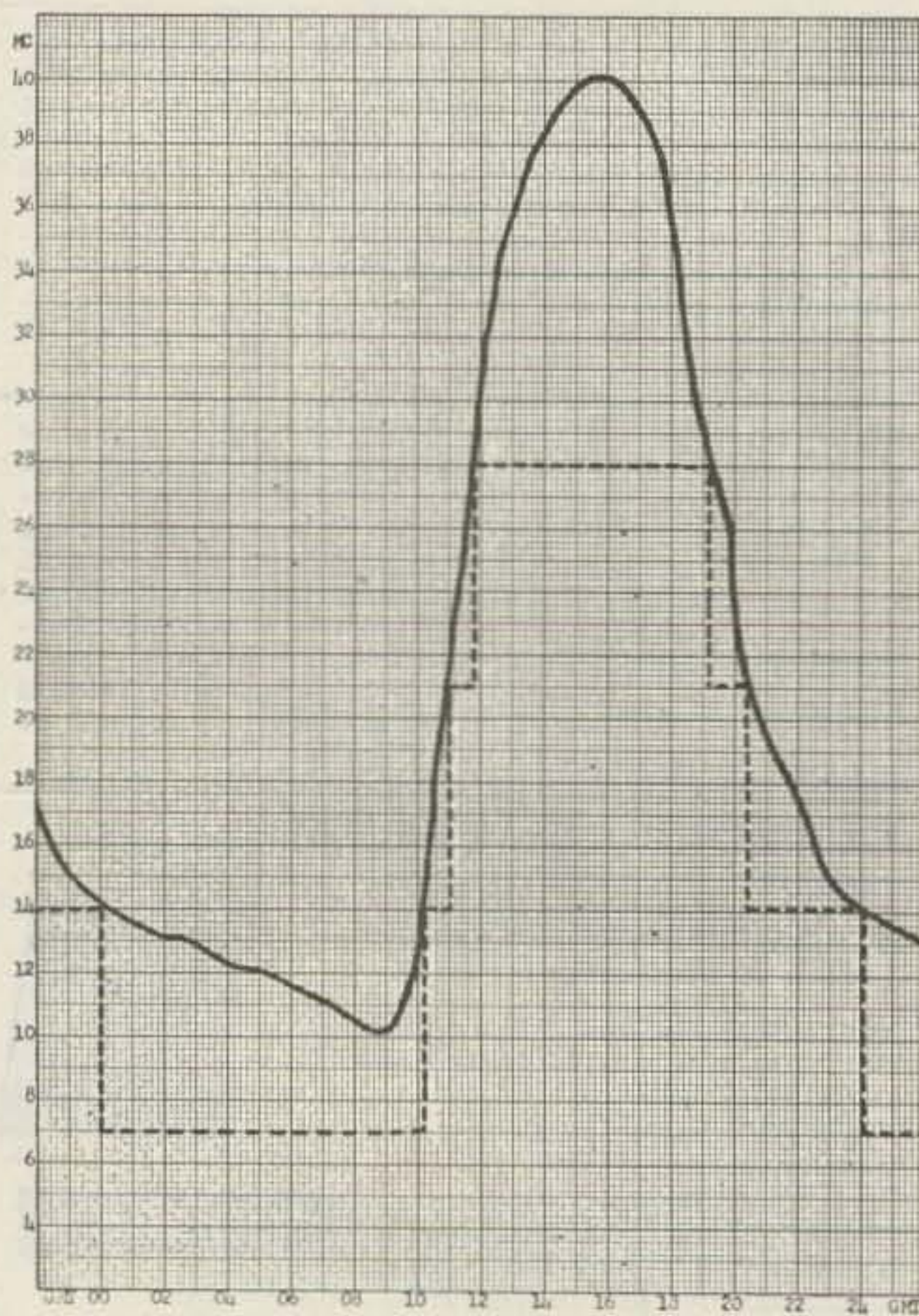

Fig. 1

Fig. 1 illustrates the Diurnal variation in MUF along with the Ham Band Frequencies (HBF) that should be used. During the nighttime hours the MUF's are quite low and the

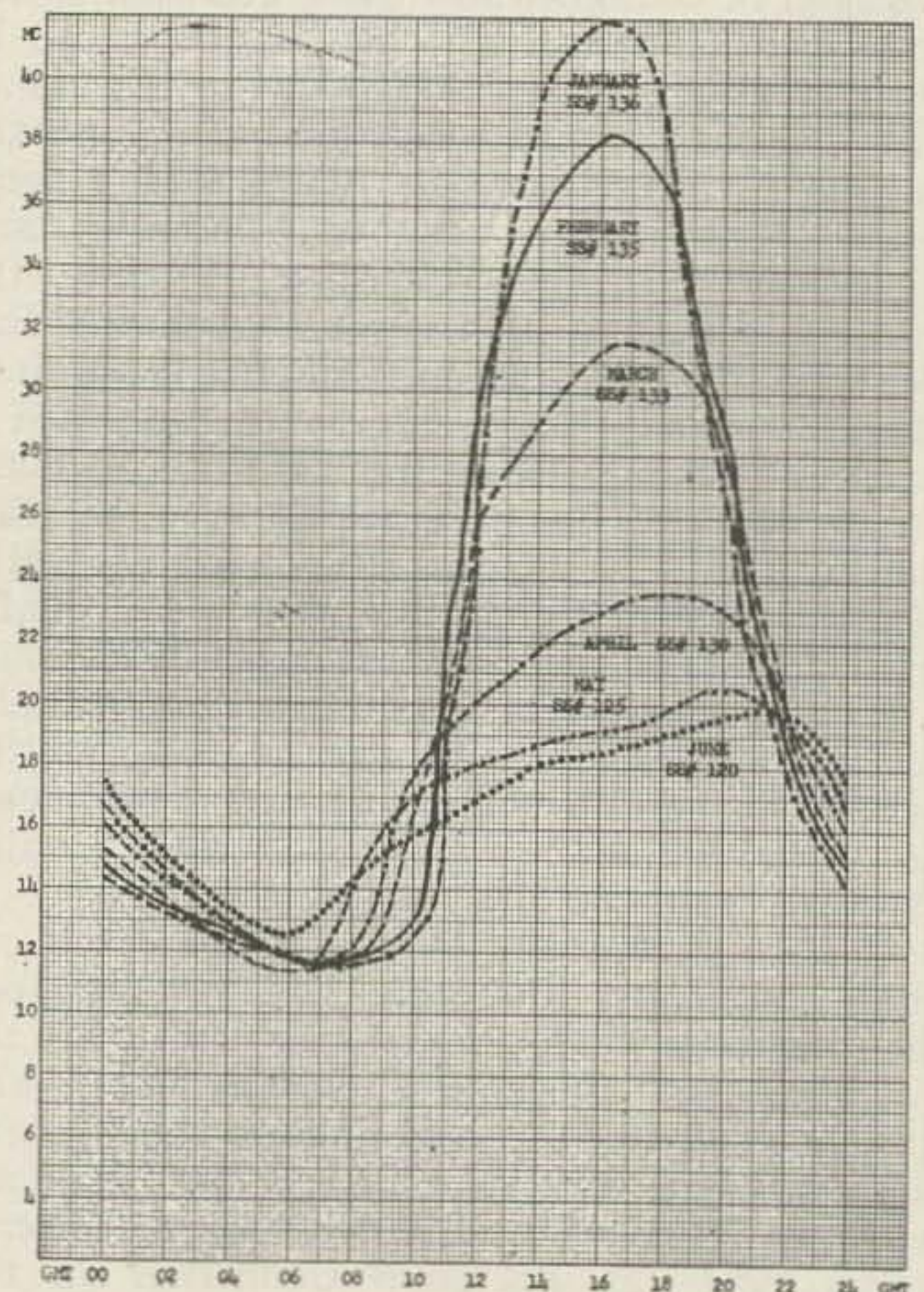

Fig. 2

PROPAGATION CHART

EASTERN UNITED STATES TO:

G.M.T.	00	01	02	03	04	05	06	07	08	09	10	11	12	13	14	15	16	17	18	19	20	21	22	23	24
ALASKA																									
ARGENTINA																									
AUSTRALIA																									
CANAL ZONE																									
ENGLAND																									
GERMANY																									
HAWAII																									
INDIA																									
JAPAN																									
MEXICO																									
PHILIPPINE'S																									
PUERTO RICO																									
SOUTH AFRICA																									
U.S.S.R.																									

CENTRAL UNITED STATES TO:

G.M.T.	00	01	02	03	04	05	06	07	08	09	10	11	12	13	14	15	16	17	18	19	20	21	22	23	24
ALASKA																									
ARGENTINA																									
AUSTRALIA																									
CANAL ZONE																									
ENGLAND																									
GERMANY																									
HAWAII																									
INDIA																									
JAPAN																									
MEXICO																									
PHILIPPINE'S																									
PUERTO RICO																									
SOUTH AFRICA																									
U.S.S.R.																									

WESTERN UNITED STATES TO:

G.M.T.	00	01	02	03	04	05	06	07	08	09	10	11	12	13	14	15	16	17	18	19	20	21	22	23	24
ALASKA																									
ARGENTINA																									
AUSTRALIA																									
CANAL ZONE																									
ENGLAND																									
GERMANY																									
HAWAII																									
INDIA																									
JAPAN																									
MEXICO																									
PHILIPPINE'S																									
PUERTO RICO																									
SOUTH AFRICA																									
U.S.S.R.																									

LEGEND

7 MC

14 MC

21 MC

28 MC

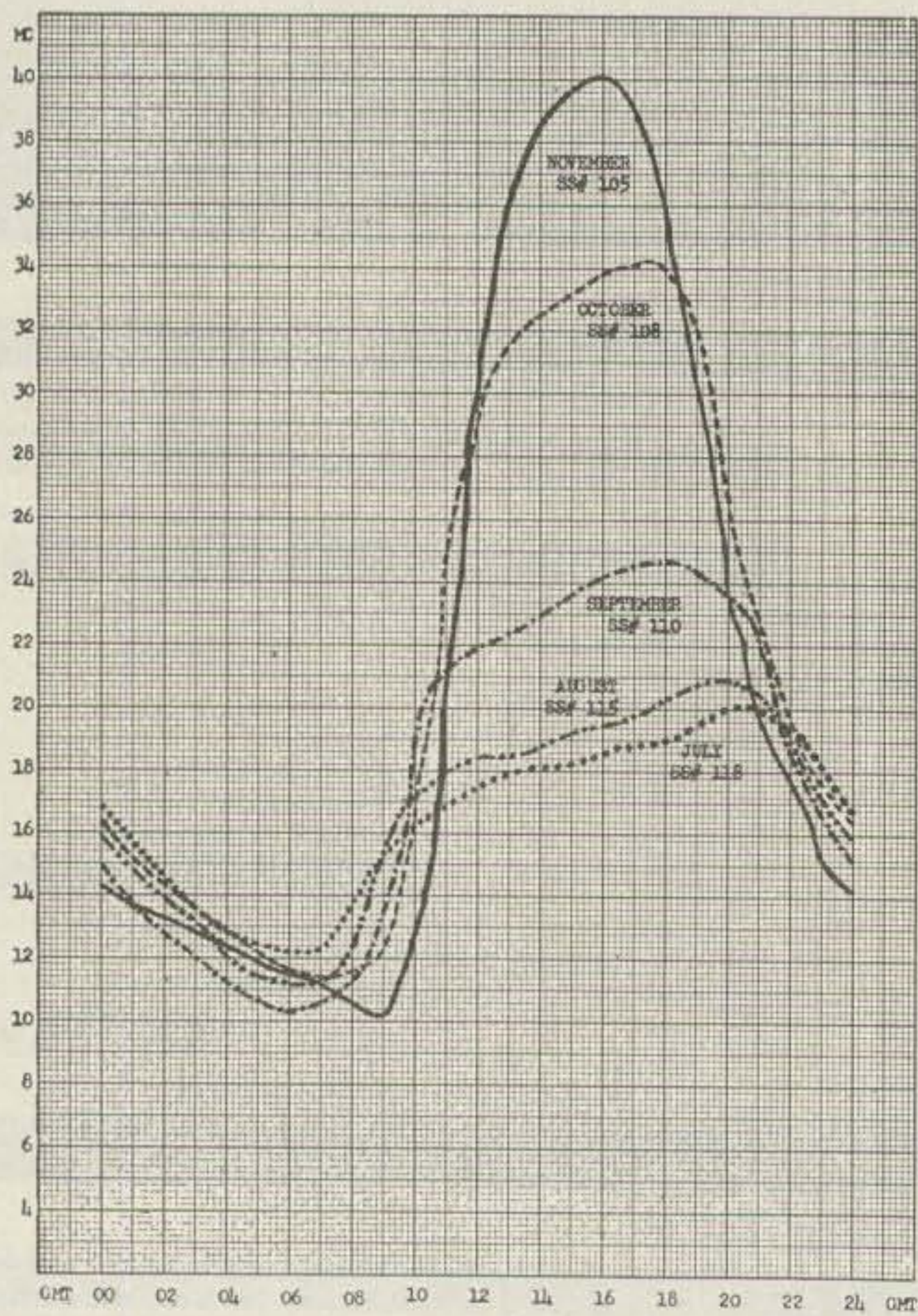

Fig. 3

see that the maximum value of MUF in the diurnal curves is increasing from Summer to Winter as the Sunspot number is still decreasing! This is the Seasonal variation in MUF which is independent of an increasing or decreasing sunspot number. Notice too that the nighttime Winter frequencies are lower than



Fig. 4

the Summer nighttime frequencies and that the Winter daytime frequencies are higher than the Summer daytime frequencies. It can also be seen that the highest MUF is reached later in the day in the Summertime than in the Winter.

The seasonal curves can be placed into three basic groups, each group containing a basic type of curve covering four months as fol-

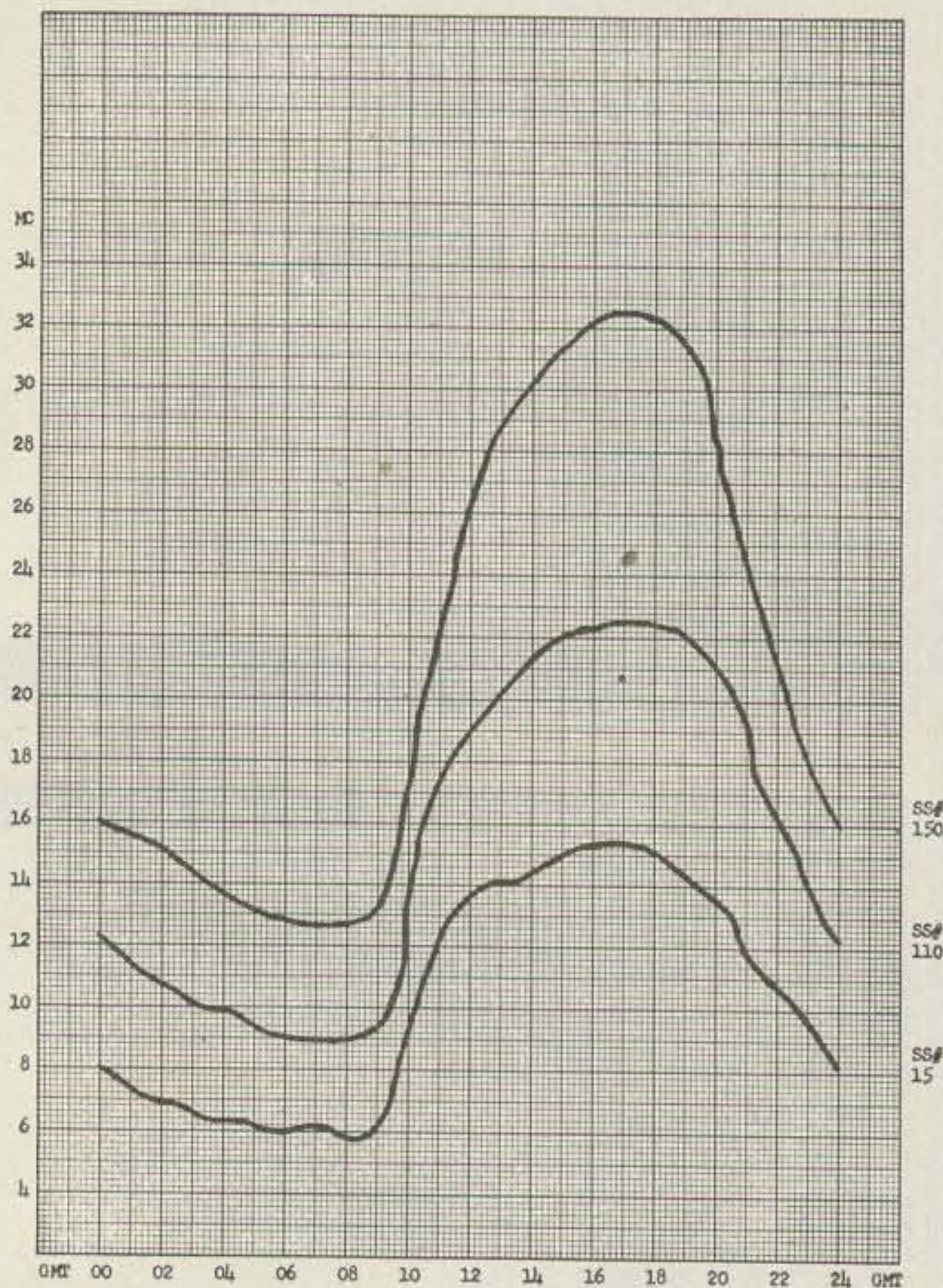

Fig. 5

lows: Winter Season—November, December, January and February; Equinox Season—March, April, September and October; Summer Season—May, June, July and August. These basic curves are shown in Fig. 4, Fig. 5 and Fig. 6 along with the Cyclical variation with sunspot number.

In Fig. 4 the highest HBF is 28 mc and this is reached when the sunspot number gets into the fifties. The lowest HBF is the 40 meter band until the sunspot numbers get as low as fifteen or lower, when the 80 band is the nighttime HBF. From this set of curves we can see that there should be some 28 mc activity this Winter, if the sunspot numbers follow those predicted in Part I, for the New York to England path.

From Fig. 5 we can conclude that there will be no 21 mc openings in September and that during the daylight hours the best HBF will be 14 mc and at night 7 mc. Towards the end of October when the transition from the Equinox curve to the Winter curve comes, is when we will find the first 21 mc openings to England.

(Turn to page 59)

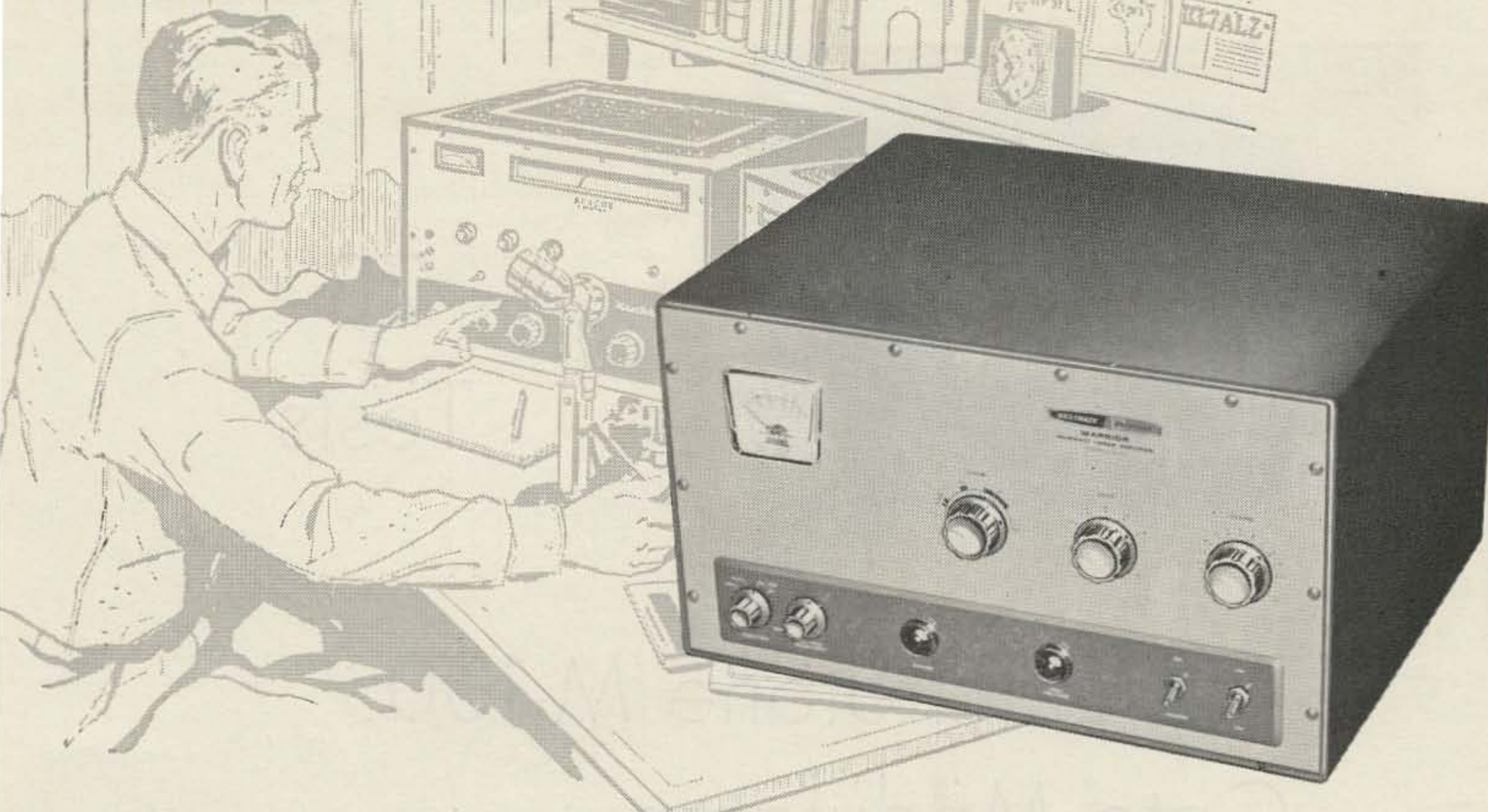

HERE'S A NEW HEATHKIT[®] GROUNDED GRID KW LINEAR...JUST \$229⁹⁵

The new Heathkit "Warrior" is a completely self-contained, desk-top kilowatt linear, loaded with special features, at half the cost of comparable units! Compare feature for feature, quality component for quality component, you'll find no shortcuts . . . only the finest watt-per-dollar value in a linear amplifier on the amateur market today!

Maximum power input: SSB—1000 watts P.E.P., CW—1000 watts, AM—400 watts (500 watts using carrier controlled modulation), RTTY—650 watts. **Driving power required:** 50 to 75 watts—depending on frequency. **Output circuit:** Variable pi-network (50 to 75 ohms). **Input circuit:** Broad banded—requires no tuning. **Input impedance:** Approx. 70 ohms. **Band coverage:** 80, 40, 20, 15, 10 meters. **Panel metering:** Switch-selected, grid current, plate current, high voltage and relative power output for ease of loading. **Tube complement:** 4-811A, 2-866A. **Size:** 19 1/2" W x 11 1/2" H x 16" D.

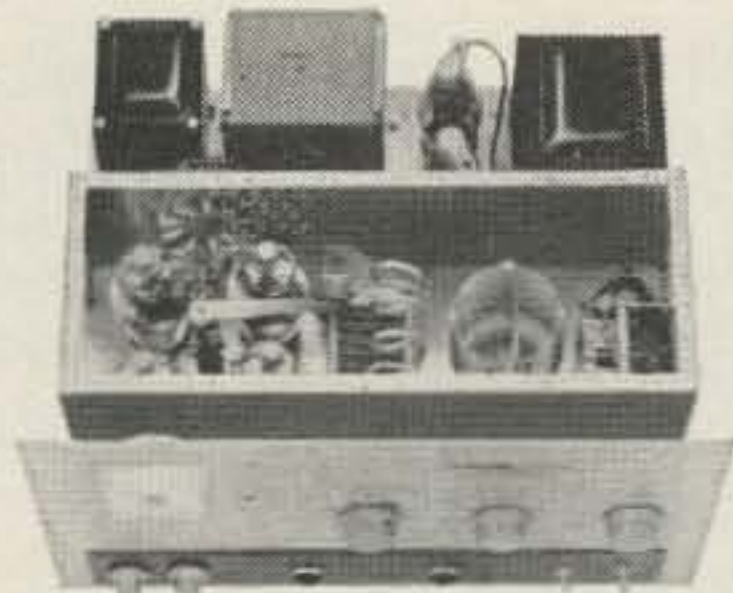

This inside view shows the neat circuit layout and husky components that emphasize quality. Note the internal shielding of plate circuit for maximum protection against TVI.

CHECK THESE FEATURES . . .

- Completely self-contained . . .* HV, Fil. and Bias supplies built in.
- Versatile . . .* May be driven by any 50 to 125 watt transmitter or exciter—no matching or swamping network required.
- Efficient . . .* Stable grounded grid circuitry allows most driving power to appear in output for up to 70% efficiency.
- Oil-filled capacitor . . .* And 5-50 henry swinging-choke provide the excellent dynamic regulation required for high peak power output with low distortion.
- Inexpensive tubes . . .* 4 paralleled 811A's and 2-866A's, forced-air cooled by silent built-in fan.
- Stable . . .* careful design provides a high degree of over-all stability in conjunction with the grounded grid circuit configuration.
- Exclusive . . .* Internal RF shielding of plate circuit for maximum TVI suppression.
- Interlocked switching . . .* prevents accidental application of HV before switching on filament and bias.
- Rugged construction . . .* 16 gauge steel chassis—1/8" aluminum front panel—welded one-piece cabinet.

Kit Model HA-10 . . . 100 lbs. \$23 dn., \$20 mo. **\$229.95**

Assembled Model HAW-10 . . .
100 lbs. \$33 dn., \$28 mo. **\$329.95**

FREE CATALOG

Send today for your Free Catalog describing over 100 different Heathkit products including Hi-Fi, Test, Amateur Radio, Marine and General Consumer fields.



HEATH COMPANY

Benton Harbor 11, Michigan

Please send my Free copy of the complete Heathkit Catalog.

NAME _____

ADDRESS _____

CITY _____

ZONE _____

STATE _____

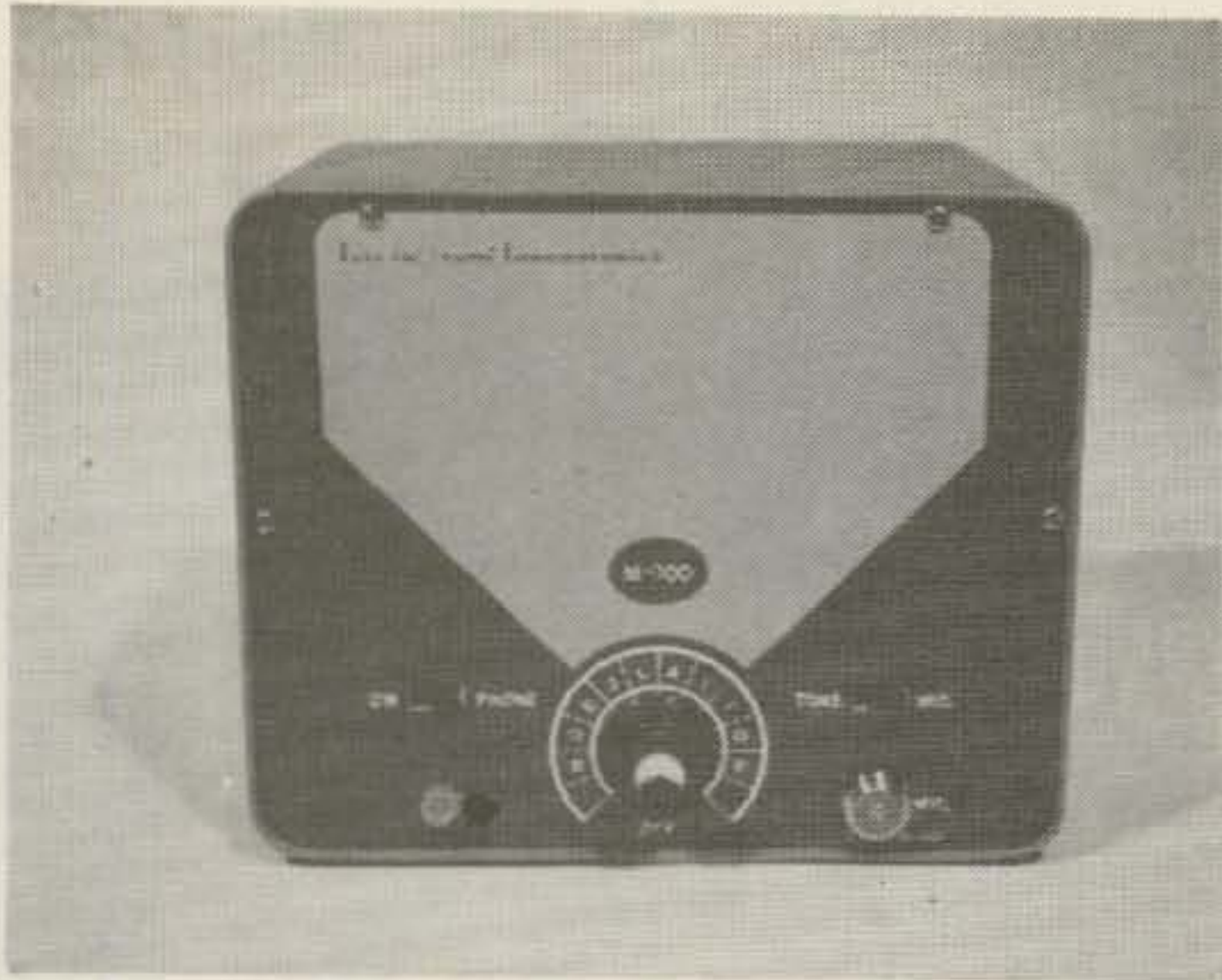

73 Tests

The Electrotone M-100 Gate Modulator

Charles E. Spitz W4API
1420 S. Randolph St.
Arlington 4, Virginia

IF you are the average ham, or more active than average, you may have passed this unit by without thinking too much about it filling a place in your hamshack. After all you may have everything. Well, *almost everything!* I admit seeing the advertisement in the November issue of 73, but since it talked mainly about commercial or home brew CW transmitters, and having no such plans at the time, my curiosity was not sufficiently aroused. Actually, there are many more applications for the M-100 around the average shack than the advertisement implied, whether as a part of the main transmitter or as an adjunct to other projects.

This is a completely self-contained audio system from mike input to modulator output with internal power supply, weighing only five and one half pounds in a compact cabinet about 5x6x7 plus in size, and containing clipping, filtering, over-modulation insurance, carrier control and even a 1000 cycle audio generator to take care of the whistlers!

Since the M-100 is designed to be inserted electrically in your amplifier screen, it obviously is limited to applications where screen grid tubes are used, and where a screen voltage of 400 or less would apply. This is not much of a hardship, since screen grid tubes are the most commonly used in transmitters and amplifiers. There is nothing tricky or difficult in hooking up the unit or operating it.

Of course your transmitter must have the stability which is required of all good phone operation. Although CW needs stability too, defects show up more readily when any rig is modulated. Everyone on phone should occasionally turn on a bfo just to see how many rigs are wobbling while modulating!

There is nothing in the M-100 which of itself would cause such untoward effects, and in fact there is a distinct advantage in it's

Application: To modulate CW transmitters or linear amplifiers. Used with Tetrodes or pentodes, single, parallel or push-pull in the range from 10 to 1000 watts, where 400 volts or less is required for the screen.

Size: 6 1/2" x 7 1/2" x 5 1/4"

Weight: 5 1/2 lbs

Power: 115/230, 50/60 cy, 30 watts

Input: Crystal or dynamic mike

Bandpass: 300-4000 cycles

Tone: 1000 cycle generator

Limiting: Speech clipping, negative and positive peak over-modulation prevention

Output: 400 peak dc volts maximum, 40 ma instantaneous dc current

Guarantee: Two years including replacement of parts and labor; tubes for 6 months

Net Price: \$49.95, delivered in U. S.

Manufacturer: Electrotone Laboratories, 2717 North Ashland Ave., Chicago 14, Illinois

Controls: On-Off Switch, Modulation Level Control, Carrier Level Control, Tone Generator Switch, CW-Phone Switch

low power requirement even when modulating a high power transmitter due to the absence of line voltage fluctuation caused by high level class B modulators reacting on a VFO.

The series gate modulator system was described in the November 1, 1957 issue of Electronics, and in the R.S.G.B. Bulletin of May 1959. The manufacturer also publishes an excellent brochure giving a detailed technical description of the circuit operation, for which he should be commended, and which is available to all who write.

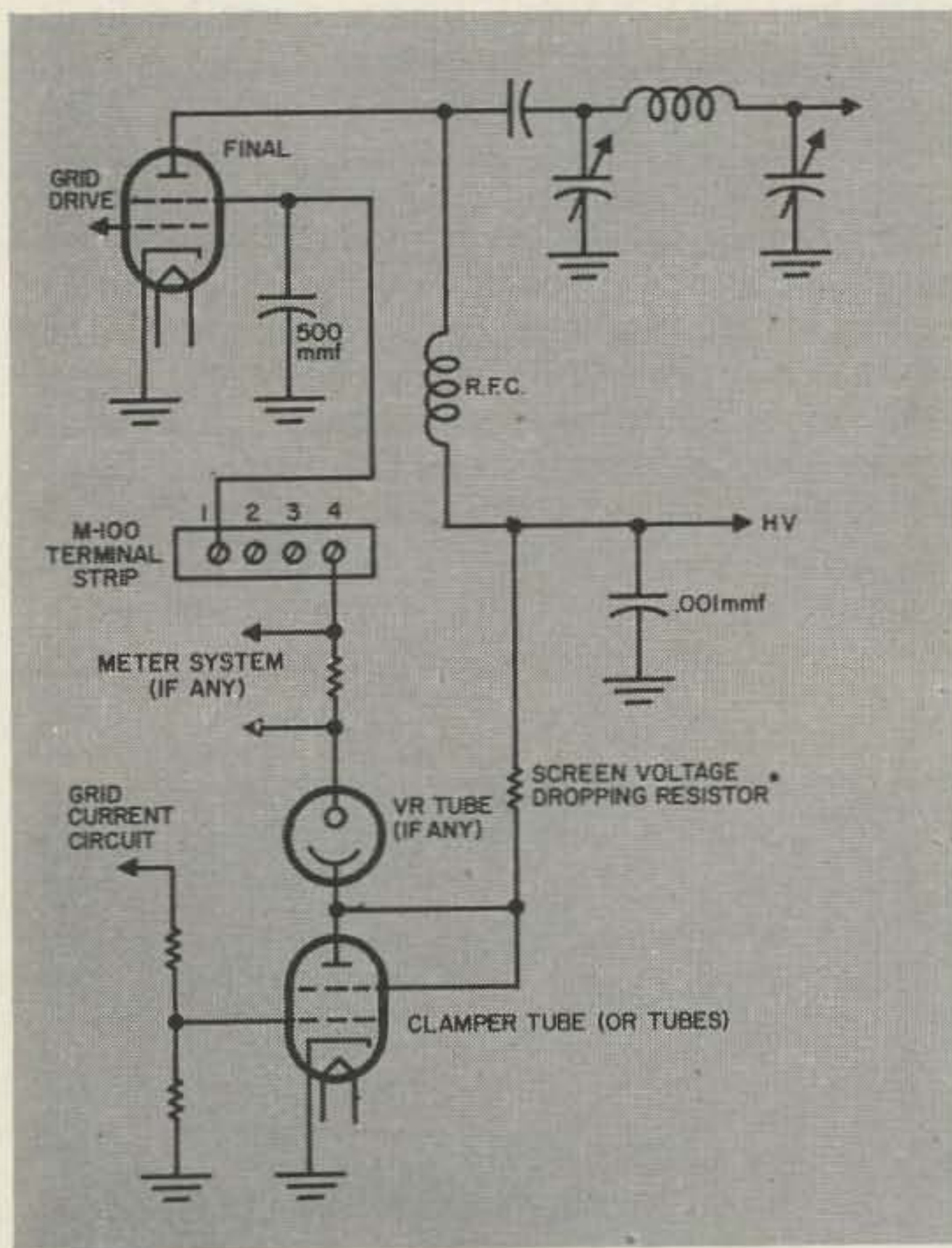

Fig. 2

Note the schematic diagram in Fig. 1. The operation is best stated in terms of dc and ac state consideration. For the dc state, if the grid of V-3A is biased to the cut off point, then the full B plus potential appears on the plate and is direct-coupled to the grid of V-3B. V-3B conducts fully and the voltage drop across the cathode resistor R-15 is applied to the final's screen. Hence, a full rf carrier is obtained. As the slider of the carrier control potentiometer is moved towards the cathode side of V-3A, the bias on the grid diminishes and V-3A starts to conduct, resulting in a voltage drop across its plate load resistor R-14. The reduced voltage appears on the grid of V-3B and reduces the plate current of V-3B proportionately. Hence, the positive potential applied to the final's screen is reduced and rf carrier level is low.

In considering the ac state, with the bias on the grid of V-3A set by the carrier level control to approximately 1 volt negative, the dc

(Turn to page 22)

Order Now from WRL's Supermart of Values

Once In a Lifetime

Just \$10⁹⁵

Hermetically Sealed Filter Choke

8.8 HY
500 MA-DC
50 Ohm DC
10 KV Insulation
7 1/4" high
7 1/4 x 5 3/4" Sides
Shp. Wt.
39 lbs.
Order 7E6

EXCLUSIVE

Never Before Such Savings!

New 15' RG8/U coax with 83-1SP plugs each end.

99c

Order 7B6

\$40 Value! - SAVE

Economy WRL Verticals 80-10M

\$14⁹⁵

Self supporting; easy mounting; no traps or radials. Heavy Illumitronics Coil. 5-minute installation. Up to 1000 watts. Coax fed; takes only 4" of space. Overall height - 23 ft. Complete instructions. Rustproof hardware, irridite treated.

Drive 3" pipe in ground; clamp on heavy Cycloac base. All band matching coil then tapped for band in use with special tap supplied. Wt.: 8 lbs.
Order V7-G-6

Same as above but with wall brackets for side mounting on house. \$12⁹⁵

Order V7-B-6

SAVINGS

SAVE 70%

Streamlined Cabinet/Chassis

SAVE 4

Complete with unpunched matching panel. Perfect for experimenter, builder. Use for transmitters, amplifiers, receivers, etc. 8"x14"x9". Wt.: 8 lbs.
Order 7X6
Only \$3⁹⁵

\$20.00 VALUE

Delay and Control Relay

Just \$1⁹⁵

Perfect for any Xmtr., linear, etc. Supply 115 VAC to the time delay relay and in 20 seconds it actuates the control relay which has 10 amp SPDT contacts to control eqpt. Both may be unplugged from bracket.
Order 7T6

LOW DOWN PAYMENT 5

WRL WORLD RADIO LABORATORIES
3415 W. BROADWAY • PHONE 32 8-1851
COUNCIL BLUFFS, IOWA

Send the following bargains: _____

Enclosed is my check _____

NAME: _____ CALL: _____

ADDRESS: _____

CITY _____ STATE _____

THE LAFAYETTE ROUNDUP OF HAMSHACK VALUES



MODEL HE-26 HYBRID PHONE PATCH

Perfect for AM-SSB Phone Patch operation. VU Meter monitors line level for Q5 phone patches. An unmatched low—

24.50



37.50 HE-28 RF WATTMETER AND SWR BRIDGE

150 watts full scale—Built-in dummy load—Wattmeter $\pm 5\%$ to 54 mcs. SWR $\pm 5\%$ for in line use.

MODEL TM-15 WAVE METER

Checks transmitter output for harmonics, parasitics, and out-of-band operation. Provided with magnetic feet. Perfect for the novice.



8.95

MODEL TM-14 FIELD STRENGTH METER

Complete, no wires to connect. Monitor transmitter output, check antennas, etc. Perfect for mobile, provided with magnetic feet.



6.95

LAFAYETTE PROFESSIONAL QUALITY COMMUNICATIONS RECEIVER

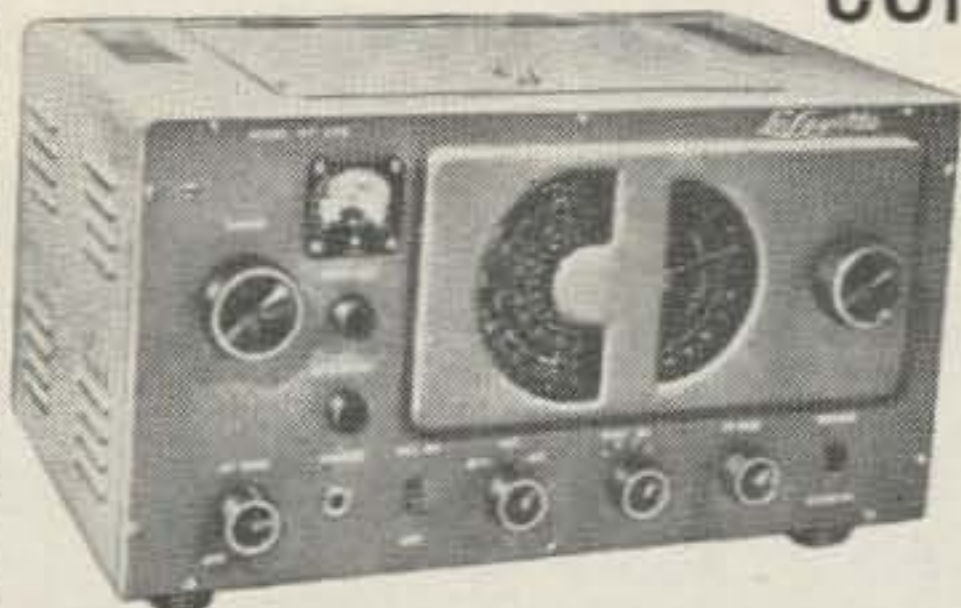

KT-200WX in Kit Form **64.50**

5.00 Down

- Superhet Circuit Utilizing 8 Tubes and Rectifier Tube
- Built-in "S" Meter with Adjustment Control
- Full Coverage 80-10 Meters
- Covers 455kc to 31 mc
- Variable BFO and RF Gain Controls
- Switchable AVC and Automatic Noise Limiter

The Communications Receiver that meets every amateur need—available in easy-to-assemble kit form. Signal to noise ratio is 10 db at 3.5 MC with 1.25 microvolt signal. Selectivity is -60 db at 10 kc, image reflection is -40 db at 3 MC.

LAFAYETTE RADIO

NEW YORK, N. Y.
100 6th Avenue

NEWARK, N. J.
24 Central Avenue

BRONX, N. Y.
542 E. Fordham Rd.

PARAMUS, N. J.
182 Route 17

BOSTON, MASS.
110 Federal Street

PLAINFIELD, N. J.
139 W. 2nd Street

165-08 LIBERTY AVENUE, JAMAICA 33, N. Y.

OTHER LOCATIONS

Lafayette Radio Dept. 73F-1 P.O. Box 190 Jamaica 31, N. Y.

\$.....Enclosed. Send Stock #..... Rush FREE 324 Page Catalog 610

\$.....Down Payment Enclosed for Stock #.....

Lafayette Easy Pay Application Will Be Forwarded Upon Receipt of Down Payment

Name _____

Address _____

City _____ Zone _____ State _____



FREE 324-Page
1961
Catalog No. 610

Cut Out & Paste
on Post Card

A Universal AM Monitor

James L. Tonne W5SUC
Outpatient Clinic, USAH
Fort Rucker, Alabama

HERE is a high quality modulation monitor that will give a dependable indication with any mode of AM transmission. It responds to the positive peak value of rf output, regardless of whether conventional or suppressed carrier transmission is employed. Or, at the flip of a switch, it will indicate average output. The detected envelope is available for oscilloscopic observation, and an audio amplifier provides an output for headphone monitoring. The metering, oscilloscope and audio circuits are electrically isolated and non-interacting.

In conventional monitors, the carrier must be present in the usual amount. Such a monitor is relatively easy to fabricate. To the author's knowledge there has been no data published on a monitor which will successfully operate on a suppressed or partially suppressed carrier signal. Suppose you're operating a phone transmitter using single or double sideband, and decide to crank in some carrier for an uninitiated fellow on the other end. How much carrier to insert usually remains a mystery. The usual modulation monitor won't help you in the least in such a situation.

All this comes about when the necessary audio amplifiers or transformers used to drive the meter circuit are considered.

The typical monitor as published in the amateur literature has another serious defect:

it responds to average modulation level, not the peak. Hence it is waveform-sensitive in that the indicated reading will vary over wide limits depending not only on percentage modulation, but also on waveform. The rf envelope must have its *peak* value measured if the monitor is to have any real value.

An oscilloscope output should be provided for waveform observation. It should not disturb the rest of the circuitry. This feature is lacking in most monitors. Lastly, it is advisable to have a built-in audio amplifier to drive a pair of headphones without worrying about adequate volume. Again, this amplifier will provide isolation between the phones and the rest of the circuitry.

Circuitry

The block diagram of this monitor is shown in Fig. 1. The arrangement of components is probably a bit unusual, but each stage does its intended job and does it well.

At the input is a variable attenuator. This is a panel control, used as a sort of calibration or sensitivity control. It is not frequency sensitive, so changing bands with the transmitter will require no gross readjustment.

Following this is the detector. A 6AL5 was used instead of a crystal diode because the

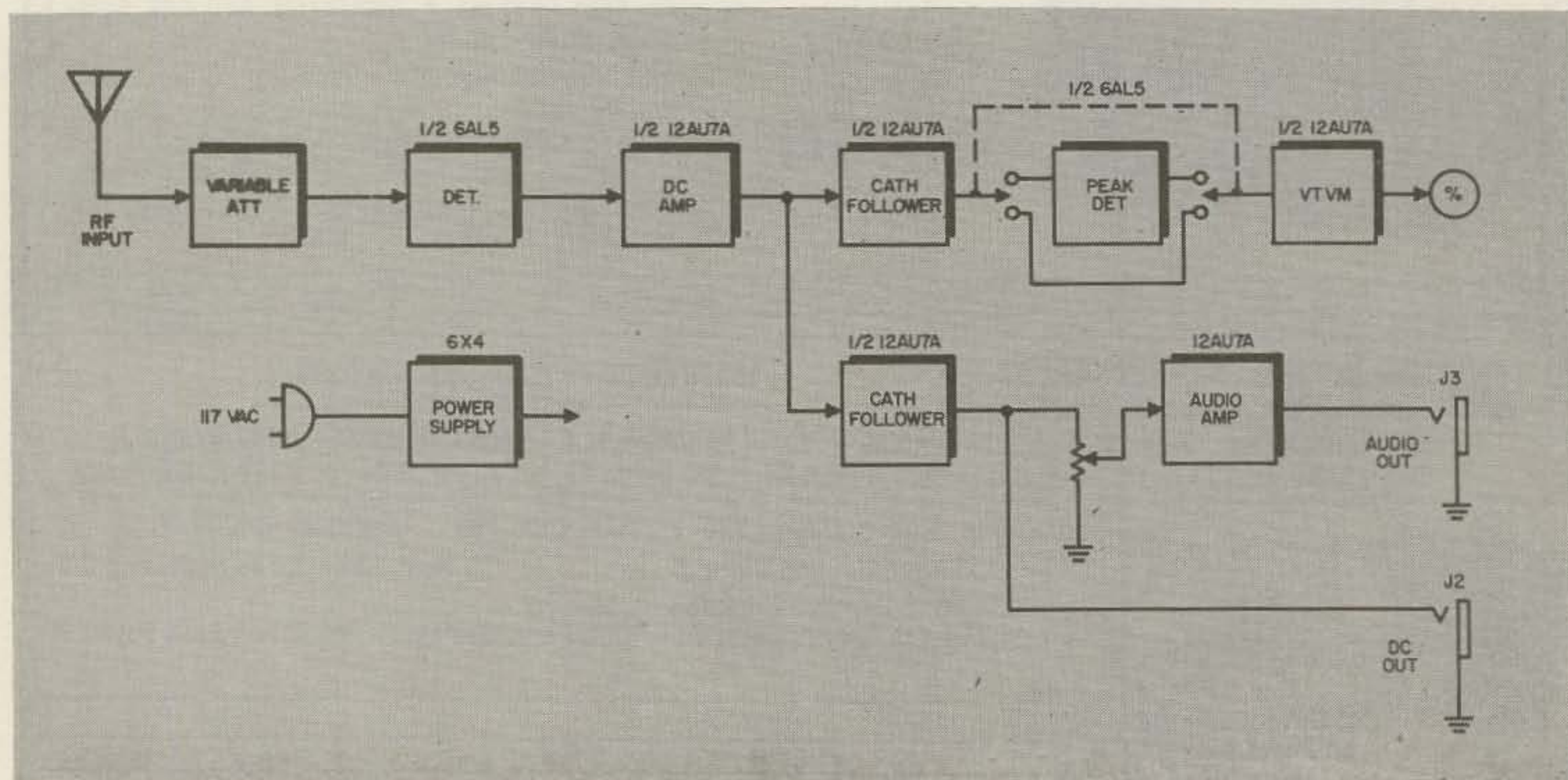

Fig. 1



THE AMERICAN RADIO RELAY LEAGUE
RADIOGRAM
 VIA AMATEUR RADIO

NUMBER 1 STATION OF ORIGIN K2VZZ CHECK 12 PLACE OF ORIGIN MAMARONECK NEW YORK TIME FILED 1355 EST DATE 3/28/61

To ALL OCDM STATION PERSONNEL

WHEN ORDERING YOUR CD STATION EQUIPMENT,
 BE SURE IT'S TMC OCDM CERTIFIED.

W. C. D.
 CHIEF OP

REC'D SENT

...For your convenience here is the latest list of OCDM certified TMC Equipment by classification...

OCDM ITEM	TMC MODEL	TMC BULLETIN NO.
OCDM R-02	GPR-90RX	SSB 205
	GPR-90RXD	SSB 205
OCDM R-04	GPR-90	SSB 179
OCDM R-16	GPR-90	SSB 179
	GPR-90RX	SSB 205
	GPR-90RXD	SSB 205
OCDM T-32	GPT-750	SSB 227
	SBT-1K	SSB 237
OCDM T-32 CW	SBT-1K	SSB 237
OCDM T-32 SSB	GPT-750	SSB 227
	SBT-1K	SSB 237
OCDM T-34	GPT-750	SSB 227
OCDM SE-100	MSR-4	SSB 196
	MSR-5	SSB 196
	MSR-6	SSB 196
	GSB	SSB 194
	GSB-2	SSB 194
	PAL-350	SSB 215
	SBE-2	SSB 195

THE TECHNICAL MATERIEL CORPORATION
MAMARONECK, NEW YORK

and Subsidiaries

OTTAWA, ONTARIO • GARLAND, TEXAS • ALEXANDRIA, VIRGINIA

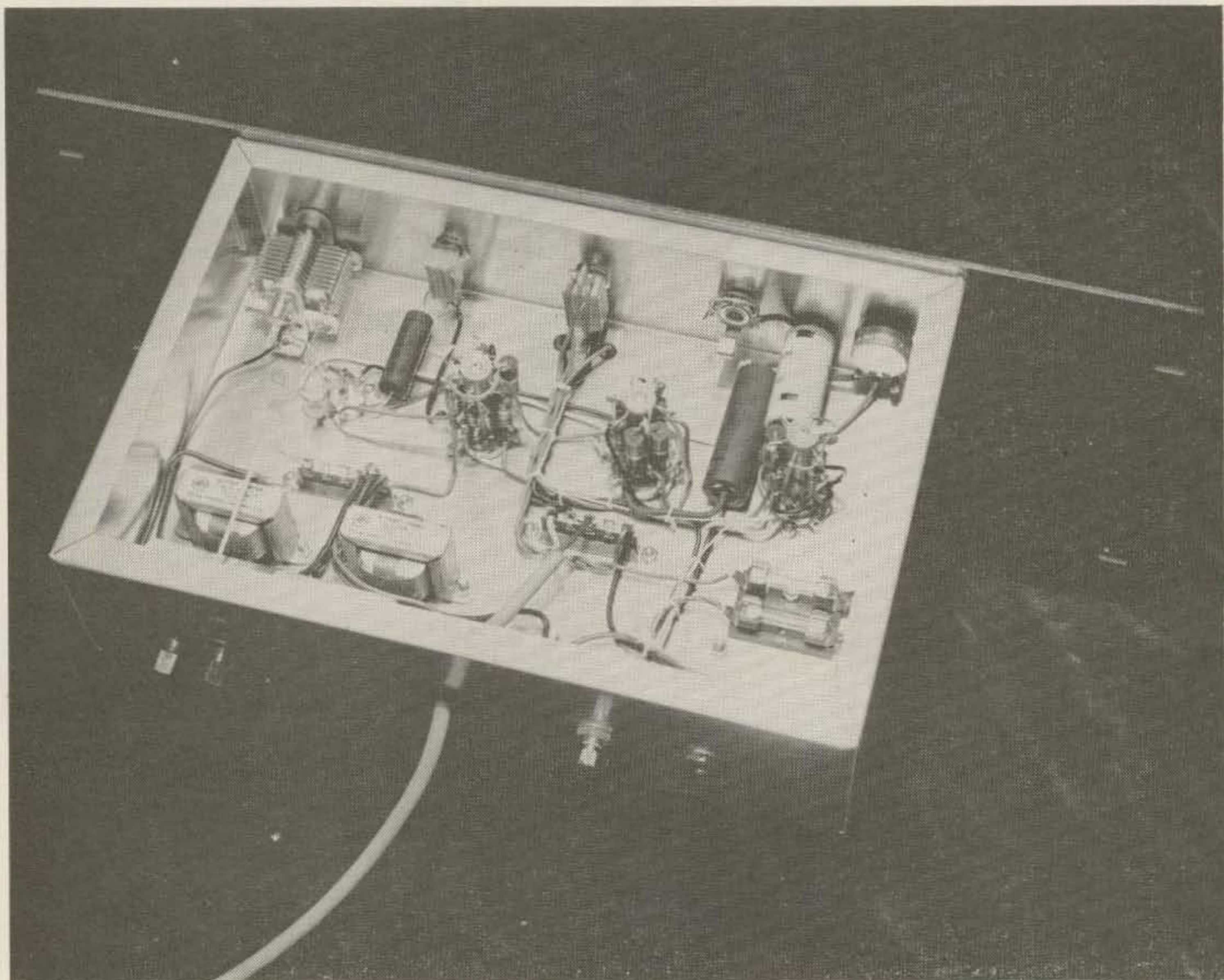

thermionic type is a bit more rugged. A bit of rf filtering and the detector output becomes the transmitter output envelope. This signal is fed right into the grid of the dc amplifier. No blocking capacitor is used nor needed.

The amplifier feeds a peak detector—but a cathode follower separates the two for isolation. This also allows the peak detector to respond very accurately to the actual waveform peaks. A simple VTVM rounds out the metering circuit.

The dc amplifier also feeds a second cathode follower, whose output is intended to go to an oscilloscope for waveform observation. It might be of interest to note that from the detector right on through to the scope output, everything is direct coupled. Hence a dc scope can be used for additional information. If such a scope is used, the trace will not bounce around the screen even with suppressed carrier or cw operation.

The scope cathode follower also drives a gain control, which selects the desired quantity of audio for the audio amplifier.

A small power supply using a 6X4 completes the picture.

Details

C1, in conjunction with C2 forms a variable capacitive voltage divider. C3, R1 and V1a form the detector. A ceramic socket is used

for V1 to minimize rf losses. R2 in conjunction with the input capacitance to V2a forms an rf filter. R3 is the plate load for this stage, the dc amplifier. Its rating is two watts in the interest of stability, important at this point. This tube operates at zero bias, with the input signal providing the proper (negative) grid voltage.

The output of this stage feeds both V2b and V3b. Each of these latter stages are connected as cathode followers. In the case of V2b this is done in order to prevent loading V2a while at the same time providing a low impedance charging path for the peak-measuring circuit (V1b, C4 and R7). The result of using this circuit is that C4 will charge to the positive (maximum) peak of the incoming signal to within 1% at the end of 3 milliseconds. High accuracy is thus assured on peak readings, regardless of the modulating waveform.

If S1 is opened ("Average" position), C4 is out of the circuit, and the unit will then read the average value of the transmitter output.

R6 is a plate current limiting resistor to keep the plate dissipation or plate current ratings of either V2b or V1b from being exceeded if either of these tubes should develop a heater to cathode short. Thus, the trouble will be kept localized and will not destroy further components. This resistor has no appreciable

You can't miss hearing this!



CLEGG ZEUS

TRANSMITTER for 6 & 2

...185 Watts of Solid "Talk Power" Tops the Band!

Again...

Clegg Laboratories brings VHF'ers a new power packed performer... A new beauty that's guaranteed to produce more carrier output and a higher level of modulation power than any other commercially built VHF amateur transmitter now available.

Put a Zeus on 6 and 2 and watch the QSO's roll in. If you like DX, listen to this! — You'll have 185 solid watts on *both* AM and CW... and you'll have *automatic* modulation control that will actually let you "out-talk" many kilowatt rigs!

CHECK THESE FEATURES AND SEE WHY A NEW ZEUS WILL PUT YOUR CALL ON THE "MOST WANTED LIST"

- High Level Plate and Screen Modulation
- Highly Efficient Type 7034 Final Amplifier
- Self-Contained Stable VFO
- Built-In Automatic Modulation Control
- Simple Band Switching and Tune-Up
- Two Unit Construction with Remote Modulator and Power Supply Conserves Space at Operating Position

Amateur Net Price: Only \$595. Completely wired and tested with all tubes, Modulator, Power Supply, VFO, cables, etc.

Clegg LABORATORIES

RT. 53, MT. TABOR, N. J. • OAKWOOD 7-6800

Ask your Clegg Distributor (listed below) for full information. He'll be glad to serve you.

- | | | |
|---|--|---|
| Arizona
Southwest Electronic Devices, Phoenix | Maryland
Key Electronics, Wheaton | Ohio
Universal Service, Columbus
Sternbergs, Inc., Cincinnati |
| California
Henry Radio, Los Angeles, Severns, Hemet | Massachusetts
De Mambro Radio Supply, Boston | Oklahoma
Radio, Inc., Tulsa |
| Connecticut
Kaufman Electronics, Bridgeport | Michigan
Purchase Radio Supply, Ann Arbor | Pennsylvania
Tydings Company, Pittsburgh
Eugene G. Wile, Philadelphia |
| Delaware
Delaware Electronics Sup., Wilmington | Missouri
Henry Radio, Butler
Walter Ashe, St. Louis | South Carolina
Dixie Radio Supply Company, Sumter |
| Florida
Amateur Radio Center, Inc., Miami
Electronic Equipment Company, Inc., Miami | New Mexico
Car Parts Depot, Roswell
Valley Engineering, Los Alamos | South Dakota
Dakota Supply, Yankton |
| Indiana
Brown Distributors, Fort Wayne
Van Sickle Radio Supply, Indianapolis | New Jersey
Federated Purchaser, Mountainside | Virginia
Key Electronics, Arlington |
| Iowa
World Radio, Council Bluffs | New York
Terminal Electronics, New York
Harrison Radio Corp., New York | Washington
Radio Supply Company, Seattle |
| Kansas
Acme Radio & T. V., Hutchinson | | |

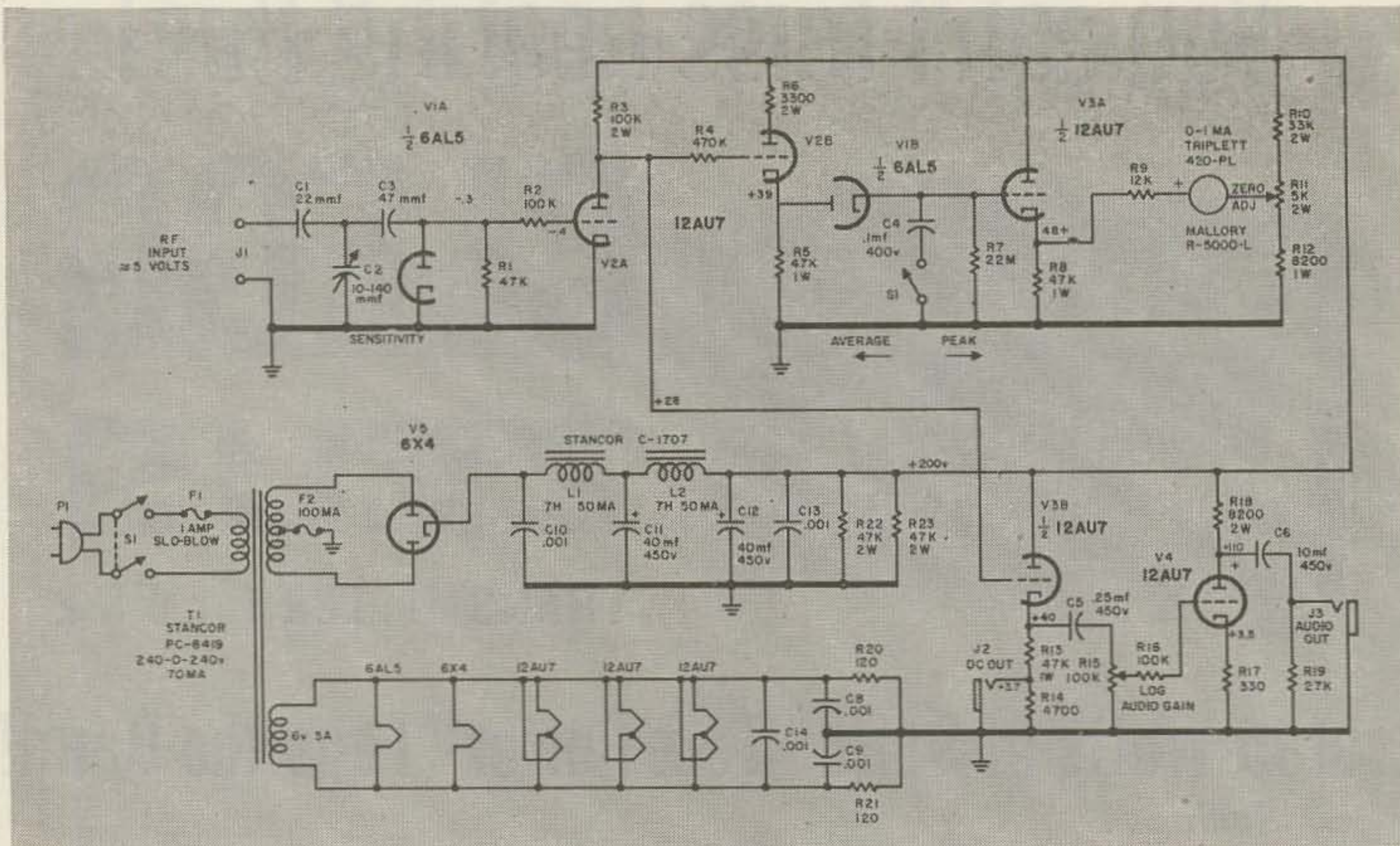

Fig. 2

effect on normal operation.

On extremely fast-rising inputs, V2b may have a tendency to draw grid current on the peak portion of the waveform. R4 prevents this effect from loading V2a.

The output of the peak-measuring circuit is fed into the voltmeter using V3a. This again is a cathode follower, to prevent loading the preceding stages while at the same time delivering sufficient current to operate the meter. R11 is the balancing adjustment for the meter, and is a rear-of-chassis screwdriver type. It is smooth in adjustment but has more than sufficient range.

The dc amplifier, V2a, drives a second cathode follower, V3b, which provides a low impedance source to operate the gain control, R15. R16, in conjunction with the input capacity to V4, prevents stray rf from activating the audio amplifier. C7 blocks the dc in the plate circuit from appearing on the load, presumably a pair of headphones. A large value of capacitance is needed here to maintain good low-frequency response. R19 drains off any leakage through C7.

A portion of the output from V3b is tapped off and delivered to J2. The output here is

about 2 volts with a dc bias which is not particularly harmful. This output is intended to go to a scope for a visual indication.

A power supply every bit as conservatively designed as the rest of the circuit is integral with the unit. A 6X4 rectifier is employed to prevent damage to the meter circuit by a quick-acting power supply. The rectifier socket is of ceramic to prevent possible trouble from heating. The dc output is filtered by a two-section choke-input filter. Due to this filtering, the signal to noise ratio in the circuitry is in excess of 60 db. Extensive rf filtering is incorporated. The primary is fused with a 1 amp slo-blo fuse, and the high voltage winding additionally has a 100 ma fuse. The filament circuit has rf bypassing and a "resistive" center tap is used for minimum hum.

Initially . . .

Turn the unit on, allow a few minutes for the tubes to stabilize, and set R11 for zero meter reading. A few feet of wire attached to the "hot" input terminal will probably pick up sufficient rf to operate the device.

Bear in mind that this unit is basically an rf voltmeter, with a sensitivity such that about 5 volts or so at the input will cause full scale deflection. With S1 in the peak position, the unit will indicate the peaks of the applied input. With S1 in the average position, the meter will indicate the average value, which is always lower, regardless of modulating waveform.

With suppressed carrier transmission, no modulation will result in no transmitter output and resultant zero meter reading. With modulation applied, the meter will read up

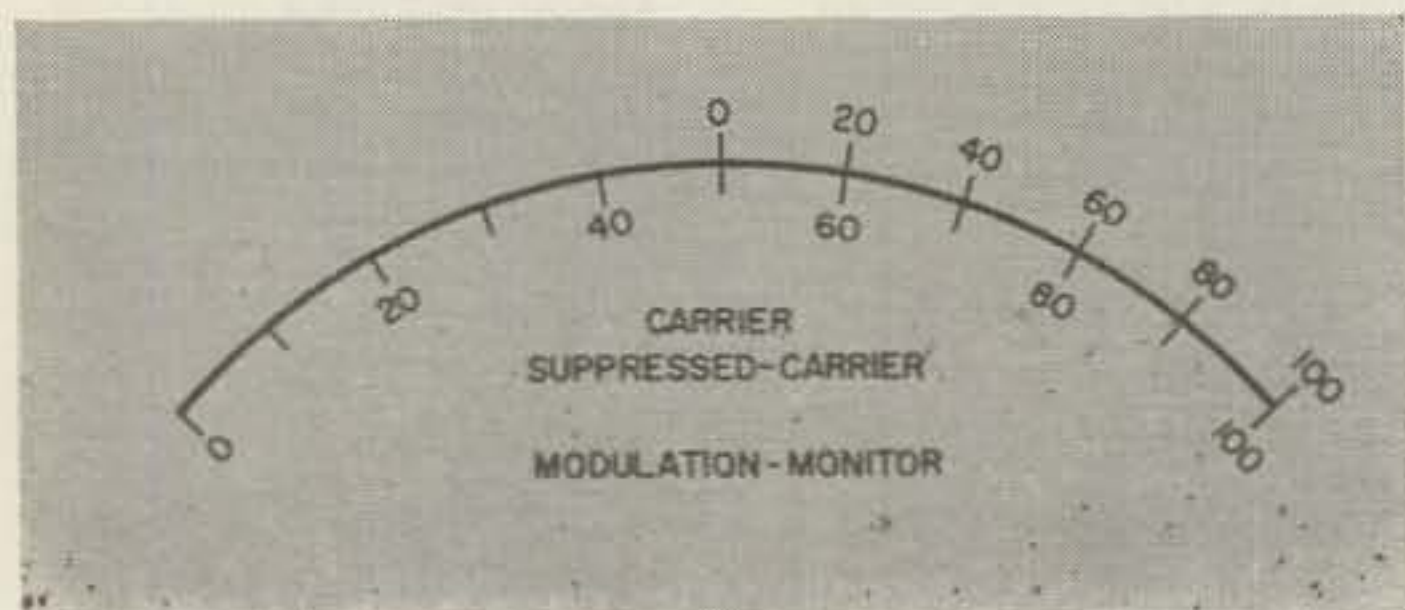
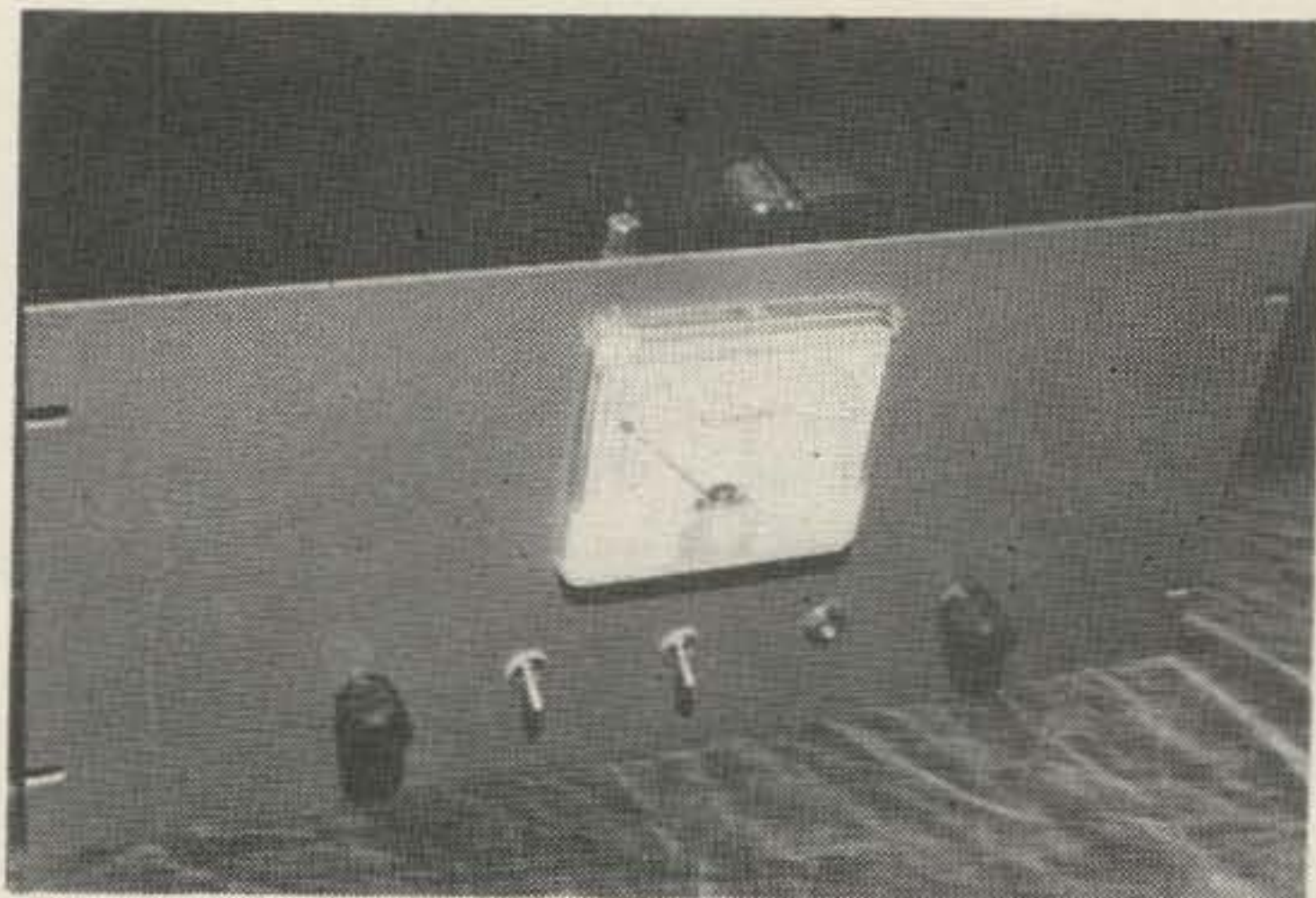

Fig. 3



scale. It will indicate peak or average according to the setting of S1. Normal procedure would be to drive the final transmitter stage to maximum linear output, as indicated on the scope, and set C2 (Sensitivity) so the meter reading is full scale with S1 in the peak position. Then the average output can be read by switching S1 to the average position.

With conventional modulated carrier transmissions, the meter reading (half of full scale, set with C2) will be the same with or without modulation if S1 is in the average position. With S1 in the peak position, the reading will double with proper modulation. Hence the scale calibration will be as in Fig. 3.

If reduced or partially reinserted carrier operation is contemplated, set sensitivity (using C2) so peaks (S1 in peak position) are at full scale. The proper amount of carrier to insert is then that which is sufficient for half scale deflection.

Note that when measuring modulated carrier transmissions, only the positive peaks are measured. This is no serious drawback, and does not penalize one if high level negative-peak clipping is used.

The audio circuitry will behave as any diode detector; it will function best when modulated carrier transmissions are used. It is, however, useful to tell aurally what kind of noise might be on a signal of any kind. The scope output is usable under all conditions, including analysis of c.w. emissions.

... and Finally

All parts in the device are standard and can be obtained by mail. Recommended or unusual types are indicated in the parts list. The vol-

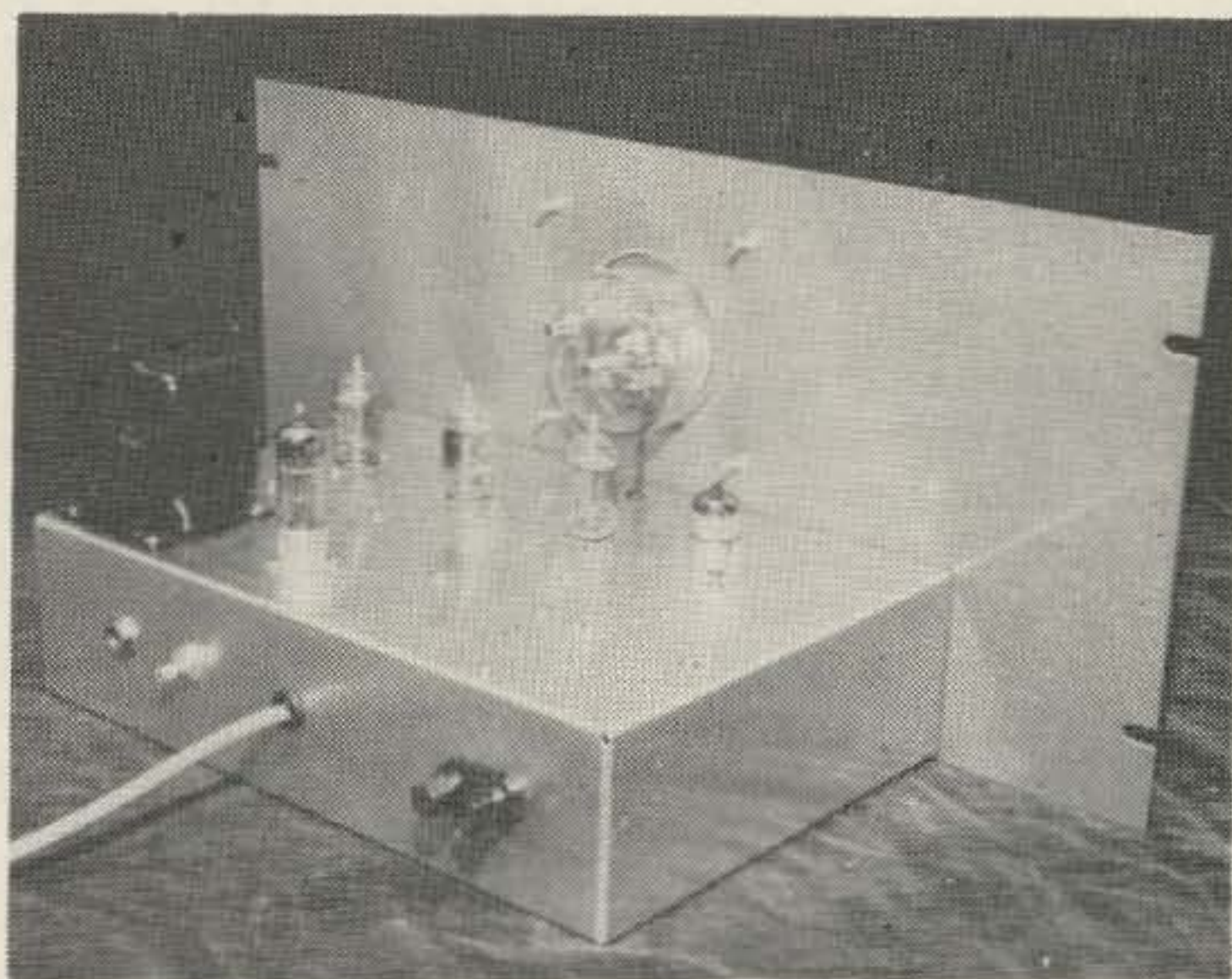

tages indicated on the schematic are dc voltages measured with a VTVM. But have no fear: the circuitry is sufficiently conservative that the device should continue to work even though the tubes are about to fall out of their sockets.

Figs. 4 (Audio Frequency Response) and 5 (Meter Circuit Response) show the accuracies of the more important circuits in the unit.

... W5SUC

Don't Break Those Good Taps

AFTER you break a few good taps with the "old tap buster" (hand tap wrench) try using self-tapping screws on sheet metal chassis and other light metal parts. It is often much easier to tap threads in holes for mounting parts than to struggle and swear while you try to get the blasted little nut started on that screw down in the corner.

Self-tapping screws are hardened and have tapered tips with either a short lengthwise slot or a fluted tip. They have four common types of heads: hexagon; slotted hex; slotted round and Phillips. If you don't have some samples in your junk box you can get a handful from larger hardware, auto supply stores and most sheet-metal shops. A fair assortment should only cost about as much as one tap.

They are quite easy to use in steel up to #16 gauge which is .0625" thick; and in

aluminum to 1/8" in thickness.

Common sizes for radio work with drill hole sizes for tapping steel to 1/16" thickness are:

Size screw	Drill Size Steel	Drill Size Aluminum
4-40	#39	#42
6-32	32	33
8-32	29	30
10-32	24	27

Put a speck of lard, grease or cutting oil on the screw tip before starting it in steel. I prefer the slotted-hex type, as I start them with a screwdriver, then finish with a socket nut driver. The self-tapping screws will substitute for taps in steel about 6 to 10 times, and in aluminum or brass almost indefinitely.

... J. J. Marlatt, K7AGI

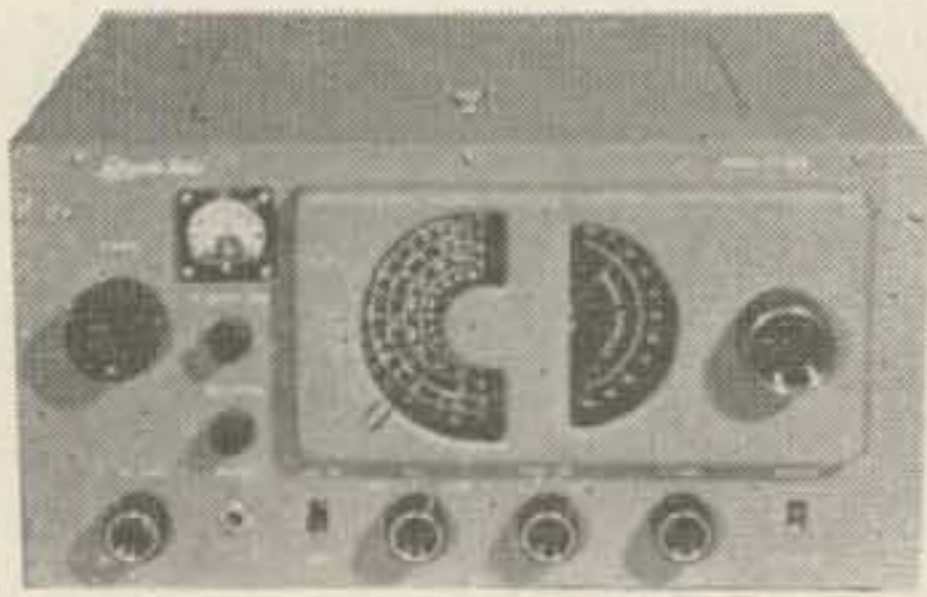

Modifying the Lafayette KT-200 Receiver

William I. Orr W6SAI
48 Campbell Lane
Menlo Park, California

IT TAKES a pretty keen eye and plenty of "know-how" to buy a good communications receiver for under one hundred dollars. Sure, there are some sets on the market selling for much less than that amount, but most of them only qualify as toys. Low in sensitivity, wide in bandwidth, and poor in stability, these receivers serve to introduce the newcomer to shortwave radio. After that, the receiver has served its purpose, and the ham or listener is ready to "step up" to a more advanced type of receiver.

What should the "minimum communications receiver" offer the buyer? Well, it should have an rf stage to provide usable sensitivity on the 10 meter band. It should have two *if* stages to produce a reasonable degree of gain, it should have an S-meter, and it should have a voltage regulated power supply for the high frequency oscillator. In addition, it should have the usual trappings, such as a bandspread dial, beat oscillator, headphone jack, standby switch and other operating aids.

Does such a receiver exist for under one hundred dollars? The answer must be a qualified "no." The author is always waiting to be shown such a jewel, but so far the wait has been in vain. However, there have been some close contenders for this interesting bargain, and one of the best of them is the Japanese-made, KT-200 communications receiver, sold by the *Lafayette Radio Co.* of New York. This article describes simple modifications to this receiver which make it serve as a very acceptable ham receiver, or general purpose shortwave receiver.

The KT-200 Circuit

A block diagram of the KT-200 is shown in Fig. 1. The receiver covers the 550 kc to 30 mc spectrum in four bands. It is rugged, well made, and uses good components. After several months of casual operations at W6SAI the receiver seemed sufficiently stable and sensitive to expend some additional effort in

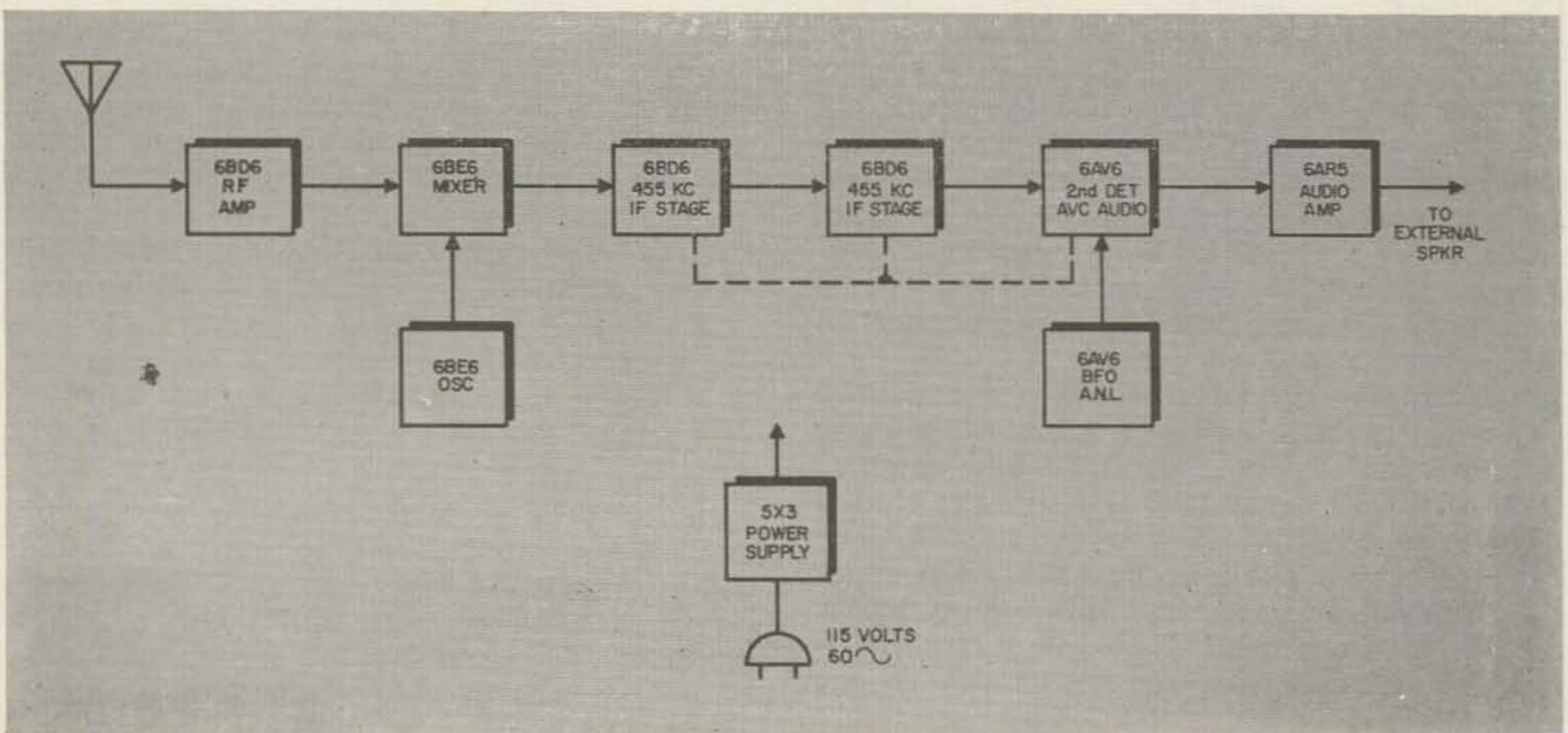

Figure 1. Block diagram of KT-200.

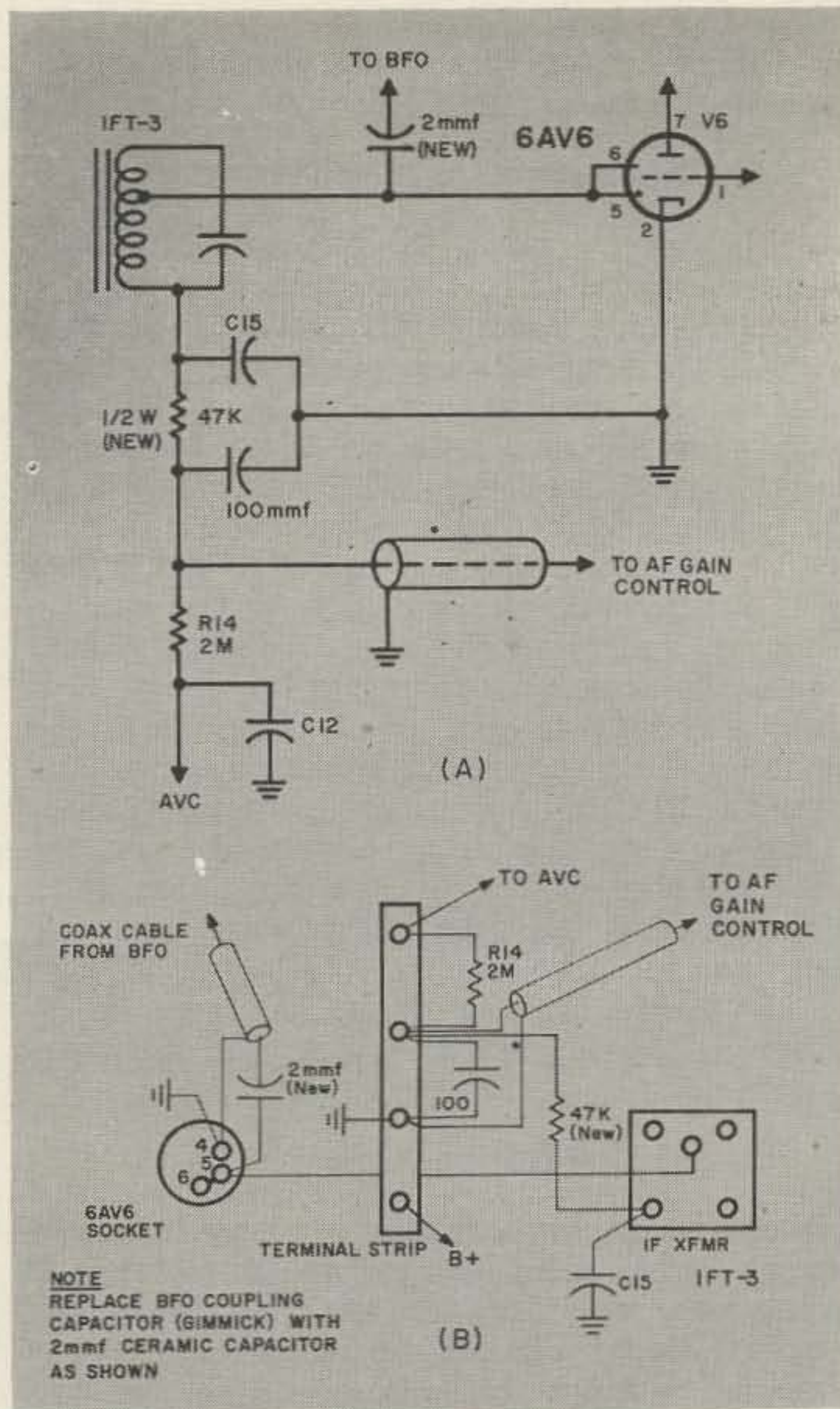

Figure 3. Revised avc circuit and parts layout, bottom view. Note: replace bfo coupling capacitor (gimmick) with 2 mmfd ceramic capacitor as shown.

making it really useable as a ham-type communications receiver. As is, the receiver seems to be fairly insensitive on 10 meters, has a tendency towards self-oscillation at the low end of the broadcast band (550 kc), and has a bad a.v.c. "pumping action" that produces an annoying frequency shift on 10 meters that varies with the strength of the incoming signal. Fortunately, these defects can be easily eliminated with a few hours work, and the modified receiver does an admirable job on all frequencies, considering its modest price. It compares favorably with other receivers falling in the \$150 price class as far as results go, and results are what count!

Increasing Gain and Sensitivity

The use of a 6BD6 tube in the rf stage does little to enhance receiver performance. This little "bottle" is the midget equivalent of the metal 6SK7, which in itself is no "barn burner." Substituting a 6BA6 (same pin connections) for the 6BD6 (V1) will go a long way towards acceptable 10 meter performance. To make this change, it is necessary to re-

duce the cathode resistor (R2) from 300 ohms to 68 ohms, and to change the S-meter series resistor (R4) from 1500 ohms to 600 ohms. These changes are shown in Fig. 2. While you are doing this chore, you should also change the cathode resistor (R8) of the 6BE6 mixer stage from 300 ohms to 80 ohms. Finally, change the cathode resistor (R13) of the last 6BD6 *if* amplifier from 1000 ohms to 330 ohms. This will boost the overall gain of the receiver by a significant amount. Loosen the bolts of the mixer (V2, 6BE6) socket and slip a socket shield base and shield over the socket.

The next step is to stabilize the receiver so that it is less prone to self-oscillation. Looking at your schematic that accompanies the receiver, you'll note that there is no screen

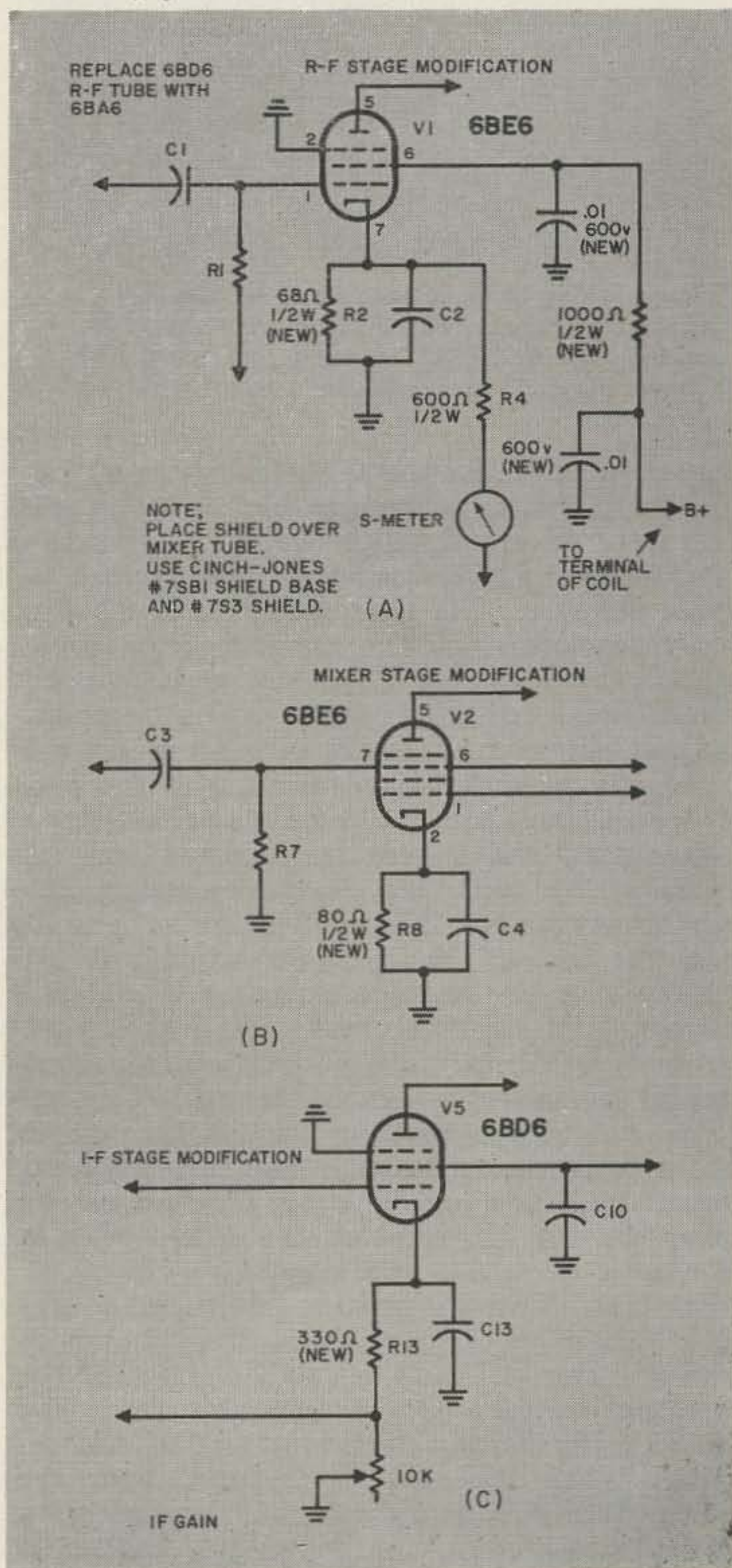

Figure 2. Circuit modifications for the KT-200 receiver.

cuit. Placement of these new parts is shown in the illustration. Simple!

Stabilizing the Oscillator

As the a.v.c. action takes place, the bias fluctuates on the rf and *if* stages, causing the plate current of these tubes to vary. The simple resistance-capacitance power supply filter produces a corresponding voltage change which wreaks havoc with the high frequency oscillator section of the 6BE6 mixer tube. An OB2 regulator tube, installed as shown in Fig. 4 will cure this annoying fault. A small hole for the tube socket is punched in the chassis as shown, and two holes are drilled to accommodate the socket mounting bolts. Easy now, you don't want to get metal filings into the variable tuning capacitor! Wire the socket and shunt the 2000 ohm voltage dropping resistor in the power supply to compensate for the added current drawn by the regulator tube. You will know the tube is operating properly when you observe the purple glow between the electrodes. This glow will change in intensity as the *if* gain control is varied, which is normal.

Additional Hints

Does the tuning of this (or any other receiver) seem a bit jumpy at 10 meters? If so, place a wee drop or two of TV "turret cleaner" liquid on the bearings of the two variable tuning capacitors. Also, minute changes in tension of the rotor bearings located at the rear of the capacitor gang may work wonders. If the bearing is too tight, the rotor tends to turn in little increments, or jumps, producing a nervous, erratic tuning effect. Too loose, the bearing produces a sloppy effect that varies when the receiver is subjected to vibration.

... W6SAI

High Voltage Insulation For Meters

Often the home constructor will go to some trouble to submount a meter because of the high voltage danger. One cause of this danger is the zero-adjustment screw which is sometimes connected to the meter circuit. This is generally a slotted rivet arrangement with an off-center projection. This projection is arranged to shift the anchor point of one of the centering springs. If the meter is disassembled, it is possible to put a piece of spaghetti on the projection and insulate it from the circuit. Then, if the insulation from the movement to the case is sufficient for the voltage to be used, the meter may be mounted normally with no danger. When it can be used, this method will save a lot of trouble.

... KØWML

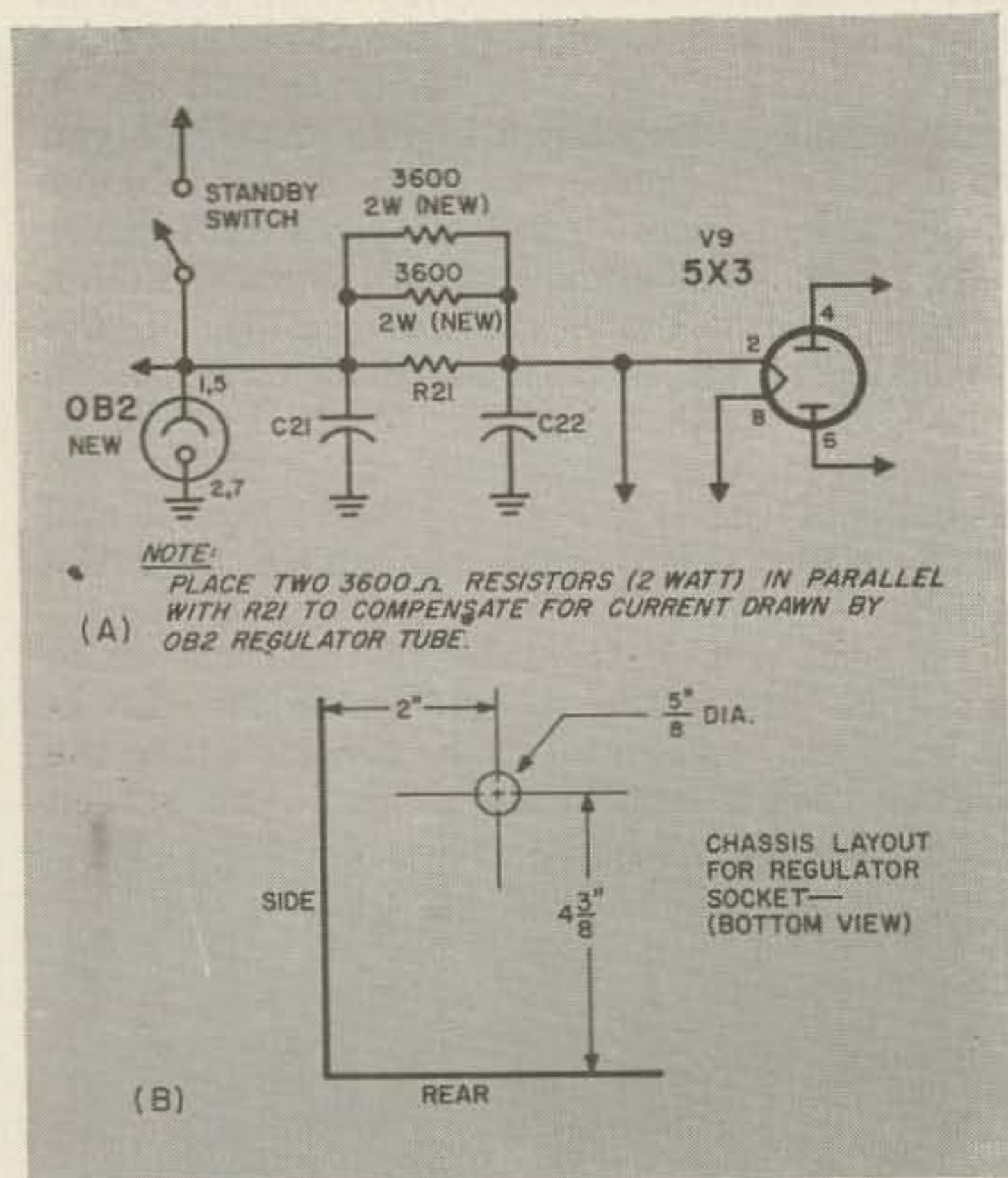
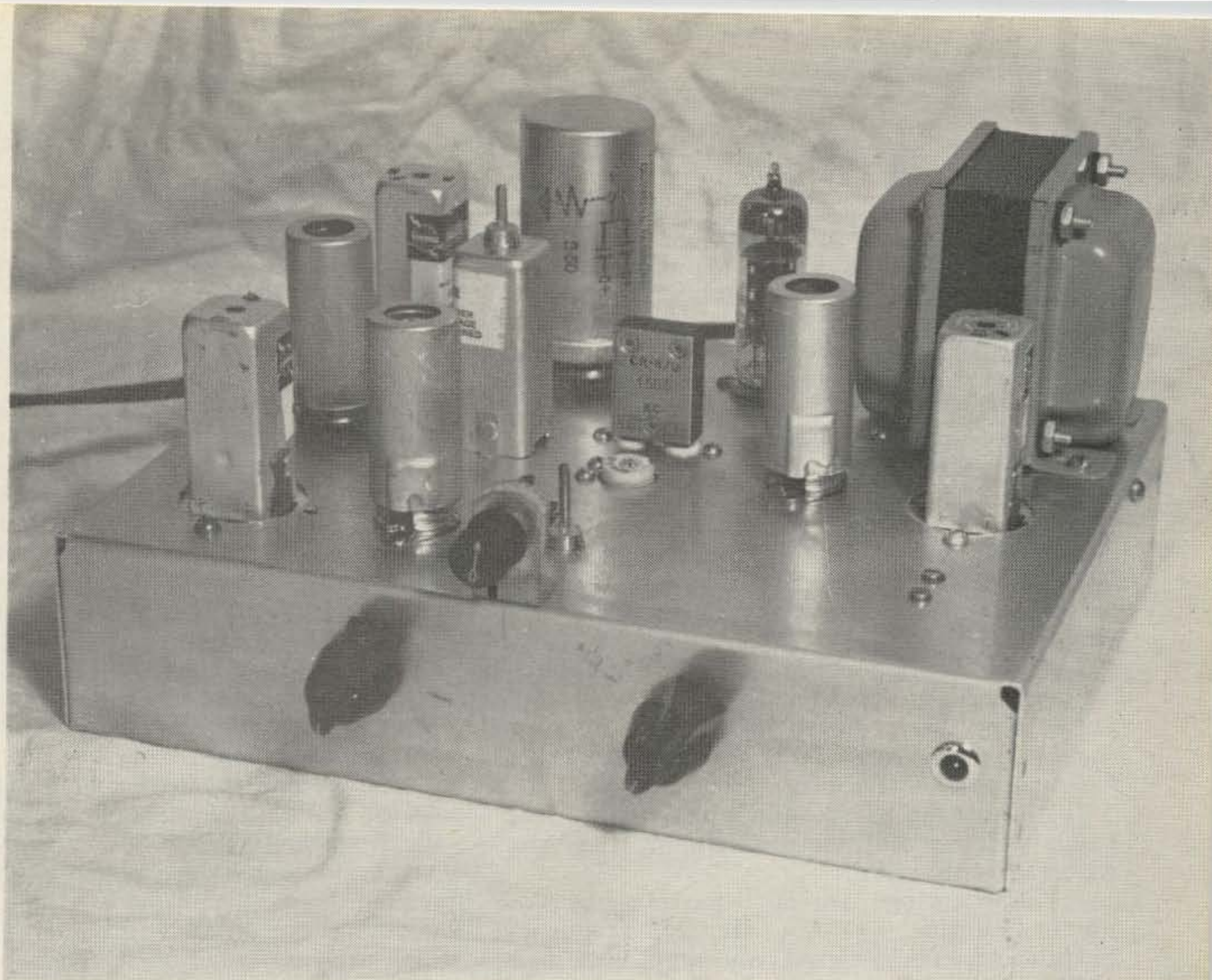

Figure 4. (a) Note: place two 3600 ohm 2 watt resistors in parallel with R21 to compensate for current drain by OB2 regulator tube. (b) Chassis layout for regulator socket, bottom view.

bypass capacitor on the 6BA6 rf stage socket (pin #6). Actually, there is one, but it is one of the power supply filter capacitors at the opposite end of the receiver that serves a double purpose. This is a bad state of affairs, to say the least, and the designer responsible for this fiasco should have his wrist slapped with a steel ruler. Examining the receiver, you will notice that a wire runs from pin #6 of the rf tube socket to a terminal of the center coil compartment. This is the screen voltage lead and should be removed and replaced with a 1000 ohm, 1/2-watt resistor. The resistor serves to isolate the screen circuit from the rest of the receiver wiring. A .01 ufd, 60v volt disc ceramic capacitor is soldered between pin #6 (screen) and pin #2 (ground) of the rf tube socket, and a second similar capacitor is placed between the opposite end of the resistor (which terminates in the coil compartment) and an adjacent ground soldering lug. The circuit changes are shown in Fig. 2. Replace the 6BD6 with a 6BA6.

The last step is to provide additional *if* signal filtering on the a.v.c. line. This change is shown in Fig. 3. As is, a small amount of the *if* output voltage is fed into the a.v.c. line and thus back into the front end of the receiver. When the receiver is tuned near the intermediate frequency (the 550 kc region) a marked instability can be noted. Additional circuit isolation is obtained by the addition of a 47,000 ohm, 1/2-watt decoupling resistor and a 100 mmfd bypass capacitor to the a.v.c. cir-



A New Panadapter Unit

J. H. Ellison, W6AOI and R. L. Hopton, W6LQK

THE principle of panoramic reception is not a new development either in theory or in the reduction to actual hardware. It has never received wide acceptance and general use by the Amateur which is probably due to two reasons, one, a limited appreciation of its utility and, two, the cost of the equipment. We propose to point out not only the obvious uses but also some of the less obvious but extremely useful ones, and also how you can build at a nominal cost, your own panadapter, which is at least equivalent in performance to any conventional commercial model. At the outset you may rest assured that it is considerably more than just an interesting piece of gadg-

etry,—it can be a very valuable adjunct to any amateur station.

Let us review what a panoramic receiver does for us before we discuss how easily we can achieve this capability. In a nutshell, the panoramic receiver presents on a scope screen, all the signals present in a wide band of frequencies at any one time. The center frequency of this band is the frequency to which the aural receiver is tuned. The aural receiver is the usual station receiver, operated in the usual manner, and listening to as few stations at once as the receiver is capable of, or as the QRM will allow! The panoramic receiver permits us to *look at* the band approxi-

mately 50 kc both sides of the listening frequency. Now, what use is this to us that might make us interested in having a panoramic receiver? Just what do we see?

All the signals within the bandpass appear as parallel spikes, spaced according to the amount they are removed from the center frequency and each other. Each type of signal has its own readily recognizable characteristic, AM, FM, SSB, RTTY, CW, Auto ignition, pulse noise, random static, etc. Fading, drifting, image signals, false signals from receiver oscillator harmonics, modulation, keying and other phenomena are readily apparent. The distribution of stations within the passband and their comparative strengths are continuously shown. Now, how do we use this information?

The presentation can be used for the following purposes:

(a) Examining propagation conditions on the band in question, for example, activity, fading, noise, static, etc.

(b) Detection of sporadic openings on dead bands without continuously combing the band with the tuning dial.

(c) Estimating percent modulation and over-modulation on AM signals, frequency modulation on AM signals and amplitude modulation on FM signals.

(d) Finding open channels for calling or QSY'ing.

(e) Spotting stations calling off the listening frequency. This is particularly useful when working foreign bands since stations suddenly appearing at the end of your call may be answering you and you can jump rapidly from one to another to check the call, knowing there are no responses in between.

(f) Spotting strong interfering stations or splatterers (without actually tuning on them) so that it is possible to move away from them for listening or calling.

(g) Identifying false signals from receiver oscillator harmonics which will move across the scope at twice the speed of other signals.

(h) Identifying image frequency signals which will move across the scope in the opposite direction from other signals.

(i) Checking keying characteristics of CW signals where the presence of spikes on leading or trailing edges of the keyed signal, indicates transients which produce key clicks, thumps and chirpy signals. You can check your own transmitter performance for many of these characteristics without having to rely on someone else's estimate or well-intentioned but frequently misleading comment.

Now we get to an important part of this discussion, namely, what equipment do we need for panoramic reception? It is possible to enjoy the advantages of panoramic reception with the below listed equipment; the regular station receiver with one take-off connection made to it, the adapter to be described

and a scope, either integral with the adapter or separate. No other gear will be "snuck in" obscurely, later in the discussion, as an essential part of the system. Moreover, the performance and utility of the receiver is not impaired in any degree.

The panoramic adapter consists of a broad band input stage which takes the signals from the aural receiver's mixer stage at the *if* frequency, heterodynes them to some other frequency, passes the signals through a highly selective system, demodulates them and puts them into the scope vertical system. In order to get the wide band presentation, the oscillator section of the panadapter mixer is frequency-swept over a wide band, heterodyning in succession each signal that comes through the broad band input stage and racking up on the scope face all the signals like a picket fence. The major stumbling block in the past to a simple panadapter unit has been the complication of getting the sweep frequency by either a mechanical system or a multi-tube reactance modulator. It is now possible to get wide frequency sweep with nothing more than a small diode and some resistors. The diode in question is a silicon diode which exhibits a varying capacity depending on the voltages which are impressed on it. These voltages are small and the current requirements are on the order of a microampere. As typical of these diodes we can look at those produced by *Hughes Aircraft* which are .265 inches long and .1 inches in diameter. When used as voltage-sensitive capacitors, the voltages are applied to the diode in the direction opposite to normal diode conduction. This is spoken of as "back-bias." Considering as a specific example the *Hughes HC 7001* we find that with a back-bias of .1 volts the diode is in effect a 90 mmfd condenser. As we increase the bias (so that the positive voltage on the cathode exceeds that on the anode) from plus 0.1 volts dc to plus 100 volts dc, the capacity changes from the original 90 mmfd to about 7 mmfd. (The capacity is proportional to the $-.46$ power of the voltage.) This means that by applying a varying voltage to this diode we can get a ten to one capacity change, which if this were the only capacity in the circuit would give a little more than a three to one frequency change. Actually, for our application we won't need anything like this swing, so we can proportion the fixed and variable capacitors and use a small voltage swing to give any amount of frequency swing desired.

Now, if we want to use this silicon capacitor in an oscillator circuit we must pick a basic voltage bias which determines the center frequency of the oscillator and vary the bias voltage at a periodic rate to either side or both sides of the basic bias. As it works out, it appears to be better to vary to both sides for the following reasons; the voltage feed system is simpler, a better capacity range is obtained

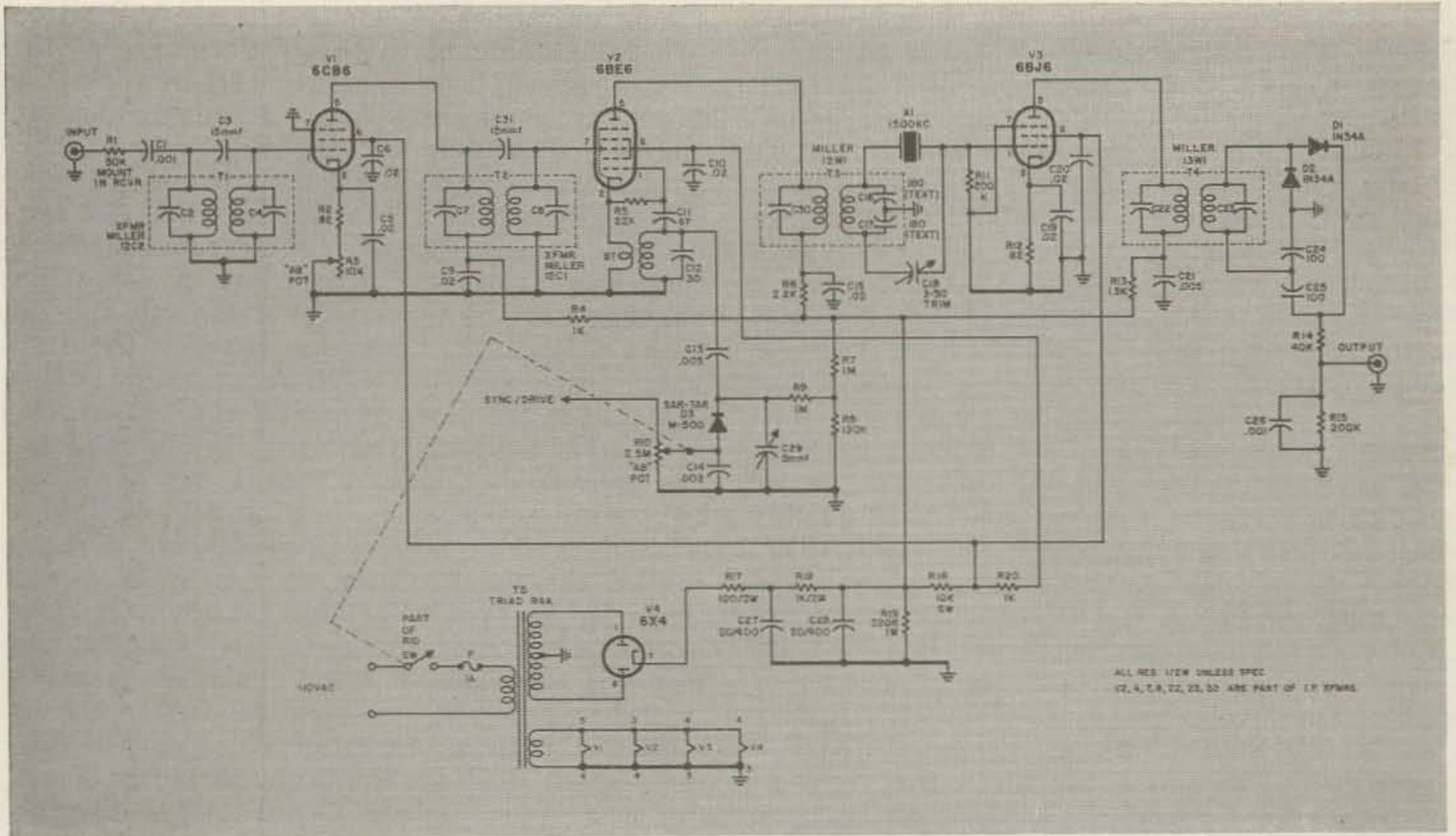

Fig. 2—T6 is a standard ferrite-cored loopstick. You will find this discussed at length in the text.

permitted using available miniature *if* transformers for this frequency, and also permitted using an oscillator frequency high enough to get a wide FM characteristic with a small capacity change in the diode. It also made practical the use of a standard ferrite-cored loop-stick of the broadcast variety as the oscillator inductor in a tickler feed-back circuit. The loop-stick has a wide range of inductance available to compensate for considerable variations in other components. This simplifies tune-up and alignment of the oscillator circuit. The oscillator bias of the mixer, as determined by the negative grid voltage, must be set as low as permissible while still getting good conversion transconductance. This precaution accomplishes two ends, first, it prevents overlapping of oscillator rf swings and diode swings which might bring the diode into the conduction range, and second, it keeps the oscillator harmonic content low and avoids spurious signals in the mixer output.

Using 1500 kc as the conversion frequency with available miniature transformers would not give adequately sharp signal peaks on the scope so we use a 1500 kc crystal to give real spikes for each observable signal as the FM oscillator sweeps the band. This improved resolution is a real joy to behold. The crystal input transformer and bridge balancing condenser are adjusted for best symmetry of signal response. This is easily done while observing the scope pattern. The crystal rejection

notches on each side of symmetry are readily distinguished (Just like in the book!). With the over-all gain available, the insertion loss of the crystal is not significant and the crystal filter circuit termination may be a simple high resistance, also acting as the grid return for V3. Note also that the crystal frequency is not critical as long as it is within the tuning range of the nominal 1500 kc transformers and as long as the crystal has no spurious responses within plus or minus 50 kc of its primary frequency.

The detector circuit differs in two respects from the usual. First, it uses a voltage doubler circuit which gives us a "free" gain of two and second, the diodes are arranged to give a positive voltage output so that with the conventional scope, the signal peaks are up from the base line. Several volts output are obtainable although less than two volts are required on the average scope with a vertical amplifier. An integral power supply is provided with a resistance-capacity filter. With the low power requirements the simple filter is more than adequate.

We have purposely avoided the subject of methods of obtaining sweep voltage until now. Since no power is required for sweep purposes we might consider that any constant, repetitive voltage might be suitable, g.e. the tube heater supply voltage, with only the proviso that it can be synchronized. However, there are considerations regarding synchroniz-

ing which we had better cover later after we discuss the scope and its functions. Let us just say in passing that sweep stability just isn't a strong point of simple sweep circuits.

Earlier we said that the scope might be integral with the adapter unit or separate. An integral scope is not recommended for three reasons. First, building a scope with all the usual controls and installing it in the adapter would limit the utility of the scope to this use alone. Second, scopes of various sizes are available in kit form for separate assembly. Third, if you already have a scope this adapter provides another excellent use for it. The functions of a scope suitable for panoramic reception are the usual ones found on all but the simplest of scopes. They are, beam intensity and focus, up and down and transverse beam positioning, vertical and horizontal amplifiers, a variable saw-tooth sweep, sync control and provision for either external or ac line synchronization.

Whatever method is chosen for obtaining the frequency sweep in the oscillator of the adapter, it is obvious that the adapter and scope sweeps must be synchronized. There are refinements of this requirement that are not immediately obvious. They are, first, only the most involved sweep methods have absolute and constant accuracy, second, the scope sweep is customarily synched with and triggered by the vertical amplifier in the scope. However, the signal passing through the vertical amplifier consists of a number of vertical pulses, some large, some small, so how does the sweep know which one to sync on,—or if it syncs on one large signal which then goes off the air it must find another large one. This operation would produce an intolerable jitter of the picture. The only alternative is to sync on some common reference source which is readily available in the ac line.

Now let's make the obvious conclusion that we will simplify the whole business by synchronizing the scope sweep to the ac line and use the scope sweep voltage for *both* the scope *and* the adapter oscillator. This way there is no longer any problem of sync and no necessity of a separate sweep in the adapter. The scope sweep can be picked off the plate of the horizontal amplifier through a .05 mfd ceramic condenser and run to an insulated pin-jack on the front of the scope. This involves no extra wires between the adapter and scope because a sync connection would have been necessary with any method considered. The scope sweep is connected through a shielded cable to the top of a 2.5 megohm potentiometer in the adapter and the desired voltage amplitude for the adapter oscillator is applied to the silicon diode anode. The potentiometer should be about 2 megohms so as not to load down the scope horizontal plates and lose horizontal size of the picture. A slow sweep should be used for good stability,—about 30 per sec-

ond gives an excellent picture.

The 2.5 megohm potentiometer permits setting the sweep width from zero to well over 50 kc each side of the center frequency. On the lower frequencies about plus or minus 25 kc is a good working range but on the higher frequencies with wider bands the greater sweep is useful. The narrow sweep permits checking signals close to the center frequency and spreading the picture improves the resolution, or the ability to distinguish between signals very close to each other. By reducing the sweep to zero the quality of modulation can be examined in detail for signals on the center frequency. Also at zero sweep the shape of a keyed signal will show up plainly. A string of dots will tell you instantly whether the keying circuit needs shaping filters, to eliminate spikes or transients. The sweep width control may be calibrated since it remains a constant width in kc regardless of the band to which the primary aural receiver is tuned.

A small variable padding condenser (about 5 mmfd) is provided as a control for band center. This may be calibrated in conjunction with the sweep width control as there is a slight shift of the band center on the scope with different sweep widths. This is due to the non-linear capacity-voltage characteristic of the diode and is not important unless it is desired to read the frequency of a signal in terms of "kc removed from center frequency." It is suggested that the sweep width control be calibrated at the 40 kc, 20 kc, 5 kc, and zero points. In fact, if desired, the potentiometer values at these points could be measured and fixed resistors and a switch substituted.

The connection to the companion receiver is made to the plate circuit of the mixer stage by connecting one end of a 50,000 ohm half watt resistor to the lead between the mixer plate and the first *if* transformer primary and bringing the other end of the resistor out through a small coax or shielded cable to the input of the adapter unit. The cable should be as short as convenient,—30 inches will be more than enough in most cases. The presence of this attachment will have no effect on the signals through the receiver whether connected to the adapter or not, since the 50K resistor is sufficient isolation for the cable termination. However, don't let the end flop around and ground because it has both rf and dc on it and can be awfully noisy! The output of the adapter goes to the scope vertical amplifier and should be shielded against stray noise or ac pick-up. There are three control levels which set the picture size, namely, the receiver rf gain, the adapter gain and the scope vertical amplifier gain. Usually, the receiver gain is set first for signal level and the adapter gain set just below the level which produces "grass" on the picture base line. The scope amplifier is then set for size.

In summary, what we now have is a fixed-tuned adapter with three controls,—gain, sweep width and band center shifter. In normal use, the scope and adapter are set only once at proper levels of sweep and gain and these remain the same regardless of the frequency band on which the receiver is operating. No adjustment or trimming is required,—if you can hear them you can see them. The basic theory and design methods have all been set forth if you want to take-off and solo but you are strictly on your own. Next month's article will show an actual unit as built and currently in use. Typical patterns with their interpretation will be shown and a dimensioned chassis layout and a list of readily available standard components will be provided. With the chassis layout, photographs and schematic the construction of a similar unit will be as easy as assembling any standard kit. The alignment and adjustment described is straightforward and un-complicated when carried out in the proper sequence and requires no periodic readjustment. Since the connection to the companion receiver requires

(Concluded next month)

no permanent alteration and leaves the operation of the receiver unaffected in any respect either with the adapter on or off, the panoramic feature can be used at will. Of course, the visual presentation is the same whether the receiver is being used for SSB, AM or CW reception. Your scope is also still available for other uses simply by disconnecting two wires or cables. Once you have gotten accustomed to using the panadapter we doubt you will ever turn it off.

Now while you are waiting for the rest of the story you may want to explore other possibilities of the silicon capacitor. The system described is applicable to small frequency changes as well as large. For example, for VFO use or FSK in teletype, the silicon capacitor can be connected across one or two turns of an inductor and a desired frequency shift obtained by dc voltages. Note that since extremely minute currents are drawn by the diode it can and should be decoupled from the voltage sources by high value resistances. This means that remote control leads can be any convenient length.

Automatic Drive Control (ADC)

Vernon L. Trexler, W5IUR
2459-A 45th
Los Alamos, N.M.

WHEN you exceed the drive to a class AB₁ amplifier tube, grid current starts to flow. If you automatically cut down the drive when a few microamps of grid current flow, you have Automatic Drive Control. ADC requires a circuit that has no output with no grid current flow, and puts out a negative voltage that is in direct proportion to the amount of overdrive. This requires a dc amplifier, which in addition to tubes, usually requires some odd voltage power supplies.

Transistors seem to be a better answer. A circuit has been worked out that is quite satisfactory. One of the problems that presented itself was the heat that might be encountered in a transmitter, so heat was applied to the developed circuit and the circuit was modified until it could withstand a temperature of 70°C (150°F). This is pretty warm. To be on the safe side the circuit should be located in a "cool" place in the transmitter, not near any large tubes or power resistors.

The circuit is a simple PNP and NPN dc amplifier; however, since there is no dc output with no ac input, and the heat problem, the transistors that are shown should be used. The first transistor does not have protective bias, so there is no output with no input. Small AA or AAA flashlight batteries are used for the 1.5 v., and a hearing aid battery for the 22.5 v.

supply.

Here is a general idea of how to "hook" it into your circuit. First, let's take a look at your bias supply for your class AB₁ amplifier. The lower the resistance of this supply the better will be your ADC. If a battery or electronic bias supply is used, all the better. If a regular negative supply is used, the smaller the resistor across the bias supply without exceeding the current rating of the bias transformer, the better your ADC 5000 ohms will be about the maximum.

This bias supply must not be tied directly to ground, but must be isolated from ground by an 82K2 watt resistor. The diagram also shows where you can connect the input of the transistor amplifier. The resistance in the series with the bias supply will not be detrimental unless you change from Class AB₁ operation.

Most AB₁ amplifiers can have at least 100K resistance in the bias supply. If you exceed the drive requirements there will be distortion added to your signal. When a few microamps of grid current flow, the distortion is still very small. 10 microamps of grid current develop a voltage of 0.82 volts across the 82K resistor, when this is applied to the input of the transistor amplifier there is an output of approximately -16 volts. This voltage is fed to the

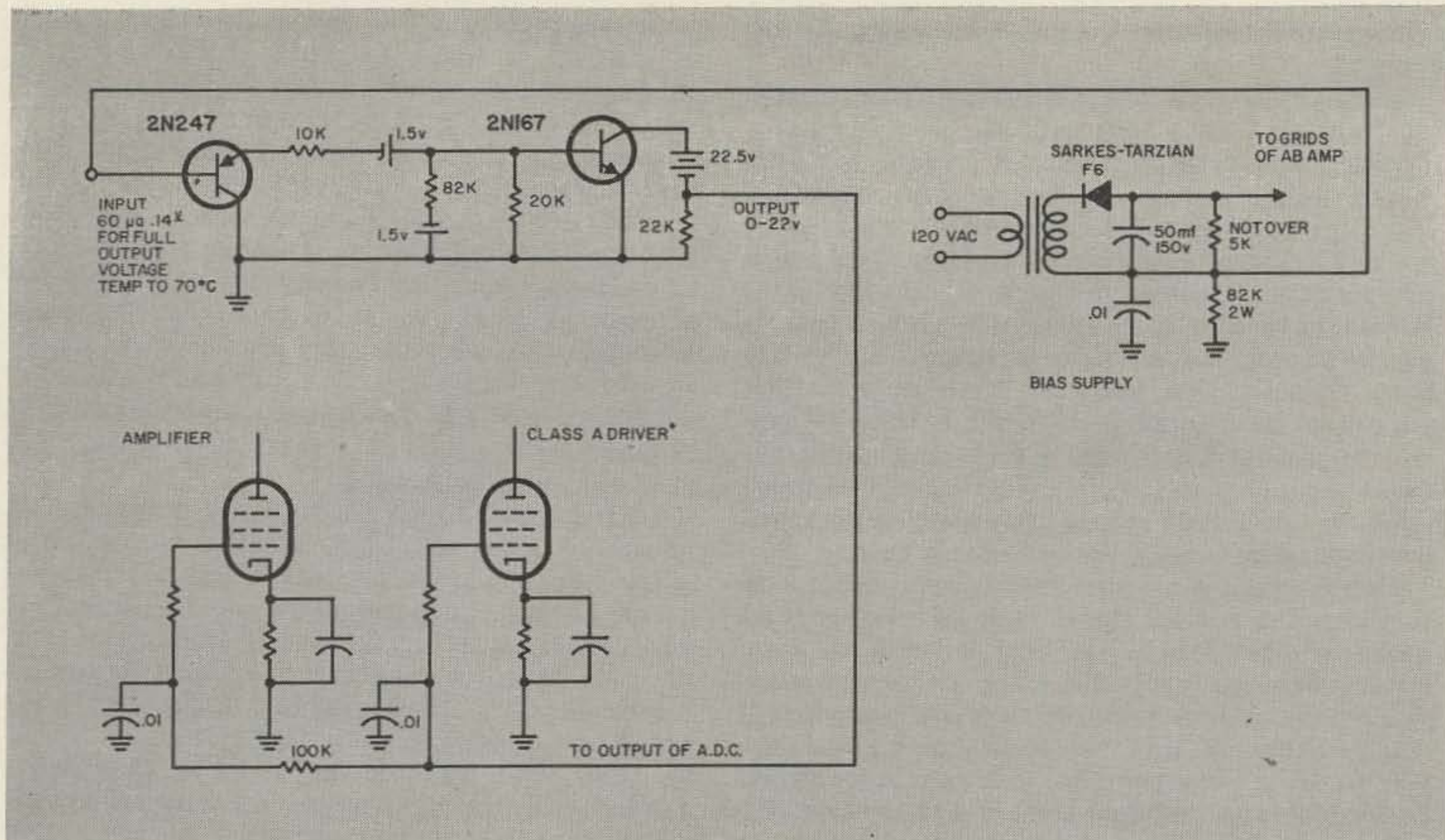

grid of a previous driver tube or tubes to cut the gain down. The tubes you select will determine how the circuit operates and how much grid current flows; remote cutoff type tubes are nice, but not an absolute necessity. If you don't have enough cutoff with one tube, try two or more.

With the proper choice of tubes for the feedback, the transistor amplifier will probably not be required to put out over eight

volts, showing a final grid current flow of approximately $6\mu\text{a}$. This could be reduced with more tubes being controlled, but proved satisfactory for me.

You should not use ADC as a means of turning all the gain control full on (although it will limit the drive and work satisfactory). The ADC should be used to keep you from "spilling" over on peaks.

... W5IUR

Dear Sir:

Allie C. Peed, Jr. K2DHA
34 Ashley Drive
Rochester 20, N. Y.

HERE comes a day in the life of each of us when we have a complaint, question, or sometimes, a bouquet or constructive suggestion to toss in some equipment manufacturer's direction. A little knowledge of how this can best be done will offer great dividends in the effectiveness and promptness of the interchange of communications.

One cardinal principle should be kept in mind from the outset in this matter. In spite of the fact that you are addressing your letter to a cold, formal, impersonal corporation, don't lose sight of the thought that the one who reads and acts on your letter is going to be a human being. He is subject to the same reactions, emotions, and limitations as you. He is not clairvoyant, so you have to tell him exactly what you have in mind together with necessary background detail to enable him to understand your problem. You are probably too close to the problem to allow you to observe strict

objectivity unless you exert special effort.

Give all the details. Even if they don't seem too important or pertinent to you. Describe your equipment exactly; model, serial number, etc. Then tell how you are using it. Exactly what's the problem? What are the symptoms of the trouble? What performance are you expecting and not obtaining? (It just could be that you are expecting more than the equipment was designed to do.) What auxiliary equipment is being used? Has your unit been modified in any way? Etc., etc.

Don't start off with a chip on your shoulder! Try to give a dispassionate objective presentation of your problem. Give the company half a chance to help you before you start calling names. They may be fully aware of a solution to your problem and eager to help you set it right. A straightforward presentation of your case will put the manufacturer's correspondent in a more sympathetic mood than a heated

denouncement of the gear and the company in general.

Don't try to hide or hold back any pertinent information. Don't represent the equipment as having just been purchased when in fact you've had it for a year or so. The manufacturer may have an exact record of when your gear was purchased and can peg you as a prevaricator before you get off the ground. If you have had some sort of accident resulting in damage to the gear at some time in the past, describe this and any local repairs that you may have made. Remember that if you end up by having to send it to the manufacturer's repair service, they will see the damaged or replaced parts anyway, and more correspondence may be necessary then.

Don't ramble in your letter. Be specific and to the point within the bounds of giving complete information. It is best to confine your letter to one general subject only. Just because you "have a letter going that way anyhow," don't throw in all the other questions that you've been wanting to ask for sometime. Different types of inquiries are answered by different people in many firms. Thus, a letter containing a multiplicity of queries will take longer to answer since it must be passed along from department to department before all of the answers are obtained.

Be sure to give your name and full address, either typed or in block letters, *on your letter itself*. Don't depend on the return address on the envelope and your scrawled signature. Many firms open their mail in a mail room where the envelopes are discarded while the letters are read and routed internally to the responsible parties. You'd be surprised at the number of letters which go unanswered in many large concerns not because of unwillingness or inability on the firm's part, but simply because there is no address to which the reply can be sent.

By all means, read the instruction manual supplied with the equipment *first*. The answer to your question might be contained in the manual. You will look pretty silly asking something which is already detailed in the manual.

Don't write an indignant follow up letter a few days after your inquiry just because you haven't received an answer as promptly as you think you should. The company undoubtedly doesn't have a man sitting at his desk just waiting to answer your letter by return mail. A big firm will receive hundreds and even thousands of letters a day. These have to be opened, read, and routed internally before the correspondent even sees them. The correspondent may have a back log of other letters received prior to yours. Your question may require considerable research and checks with the project engineer, the service department, the parts department, etc. And finally, dictation and transcription may take a day or so. This whole process takes time, so show

your appreciation for the service you expect by having a little patience. Incidentally, in subsequent correspondence, if you address your letter to the original correspondent, don't be surprised if the reply takes even longer. Letters addressed to individuals are usually delivered unopened to the addressee who may be out of the office on a business trip or vacation. Hence, your letter may not be opened for a week or more. It is better to address your letter to the company and then to the attention of the individual if you wish. Letters so addressed are usually opened and referred to another correspondent assigned to cover for one who may be absent.

If you don't receive a reply in a reasonable length of time, don't "fly off the handle" and start calling people names. Write a polite inquiry giving the date and general subject of your previous letter. This will enable the company to attempt to trace your first letter. It might be that they couldn't make out your name or address on your first letter. It might be that your first letter or the reply went astray someplace. It might be that an honest error in office routine resulted in the letter going unanswered. It might be that they are still holding your letter awaiting engineering data. Give the firm a chance to straighten these matters out.

If you still don't get a reply in say, two or three weeks more time, then you'll have reason to begin to sound off. There are several courses open to you if you feel that a firm is purposely dodging its responsibility in providing service information. You can complain to the dealer who sold you the equipment. You can write the president or general manager of the company. And most effective of all, you can complain to the editor or advertising manager of magazines in which the company advertises. Magazines are very sensitive, for moral as well as legal reasons, about advertisers who don't perform up to ethical standards.

Finally, be reasonable in your questions. Don't expect or attempt to establish a penpal relationship with your correspondent. He probably has enough letters to answer anyhow, and he won't look kindly upon the additional load of "regulars" with trivial questions. You'll wear out your welcome rather soon if you try this. Most manufacturers are happy to provide service information so long as it relates to the proper use of their equipment, but they are not in business to provide you with a running consulting service on all of your electronic problems.

One additional point. Re-read your letter before you mail it. It is well to leave it overnight, or for a few hours at least, and then read it again. If it still makes sense it is probably all right. Hastily written letters often contain inconsistencies or omissions which are easily caught by re-reading with a fresh mind.

DEPARTMENT OF COMMERCE
RADIO DIVISION

REVISED U. S. AMATEUR REGULATIONS

Superseding those dated March 6, 1928

An amateur station is a station operated by a person interested in radio technique solely with a personal aim and without pecuniary interest. Amateur licenses will not be issued to stations of other classes.

Amateur radio stations are authorized for communication only with similarly licensed stations, except as indicated below, and on wave lengths or frequencies within the following bands:

Kilocycles	Meters	Kilocycles	Meters
401,000 to 400,000	0.7477 to 0.7496	8,000 to 7,000	37.5 to 42.8
64,000 to 56,000	4.69 to 5.35	4,000 to 3,500	75.0 to 85.7
30,000 to 28,000	9.99 to 10.71	2,000 to 1,500	150.0 to 200.0
16,000 to 14,000	18.70 to 21.40		

and at all times unless interference is caused with other radio services, in which event a silent period must be observed between the hours of 8 p. m. and 10.30 p. m., local time, and on Sundays during local church services.

Amateur radio telephone operation will be permitted only in the following bands:

Kilocycles	Meters
64,000 to 56,000	4.69 to 5.35
3,550 to 3,500	84.50 to 85.70
2,000 to 1,715	150.00 to 175.00

Amateur television and operation of picture transmission apparatus will be permitted only in the following bands:

Kilocycles	Meters
60,000 to 56,000	5.00 to 5.35
2,000 to 1,715	150.00 to 175.00

Spark transmitters will not be authorized for amateur use.

Amateur stations must use circuits loosely coupled to the radiating system or devices that will produce equivalent effects to minimize key impacts, harmonics, and plate supply modulations. Conductive coupling, even though loose, will **not** be permitted, but this restriction shall not apply against the employment of transmission line feeder systems to Hertzian antennae.

Amateur stations are not permitted to communicate with commercial or Government stations unless authorized by the licensing authority except in an emergency or for testing purposes. This restriction does not apply to communication with small pleasure craft such as yachts and motor boats holding limited commercial station licenses which may have difficulty in establishing communication with commercial or Government stations.

Amateur stations are not authorized to broadcast news, music, lectures, sermons, or any form of entertainment, **or to conduct any form of commercial correspondence.**

No person shall operate an amateur station except under and in accordance with an operator's license issued to him by the Secretary of Commerce.

SEPTEMBER 1, 1928.

W. D. TERRELL,
Chief, Radio Division.

U. S. GOVERNMENT PRINTING OFFICE: 1928 11-9042

Submitted by Wells Chapin W8ONL, ex-W2DUD, W1DUD,
W0DUD, W9DUD, NU9DUD, 9DUD, 9EGQ, 9AZS.

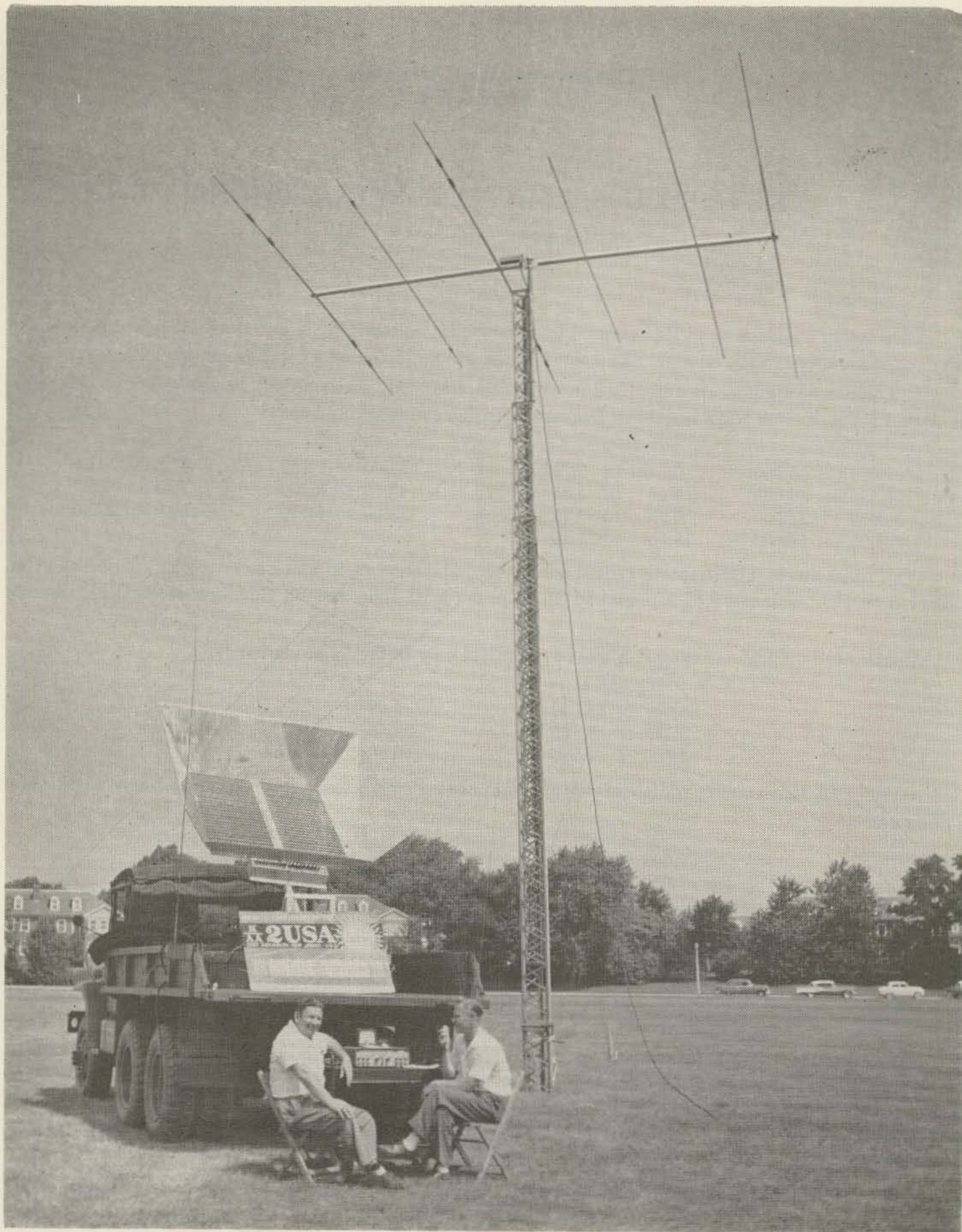

New Field-Day Power Source

Though this demonstration was made primarily for the publicity involved, it still brings home to us some hints on things to come. K2USA set up shop out in a field down at Fort Monmouth, New Jersey and worked quite a few countries on 20 meter sideband. The rig consisted of the little Hallicrafters transceiver feeding a Telrex TM-30 Tri-Band beam and powered entirely by solar cells. There are 7800 cells in the power unit and they provide 250 watts at 12 volts for this demonstration.

New Product

Printed Circuit Faraday Shield

The little comb-like printed circuit slipped between these two Air Dux coils allows highly efficient electro-magnetic transfer between the coils, while nullifying electro-static coupling. I. e., Faraday shielding, with coil Q's as high as 500. Now available for any special series or standard Air Dux coils. While you're writing to tell them you saw it in 73, you might ask for the sheet of design specs on their complete line of high-Q air wound coils for amateur use. The post card you are now whipping out of your post card locker should be addressed to Illumitronic Engineering Corp., 680 E. Taylor Street, Sunnyvale, Calif.

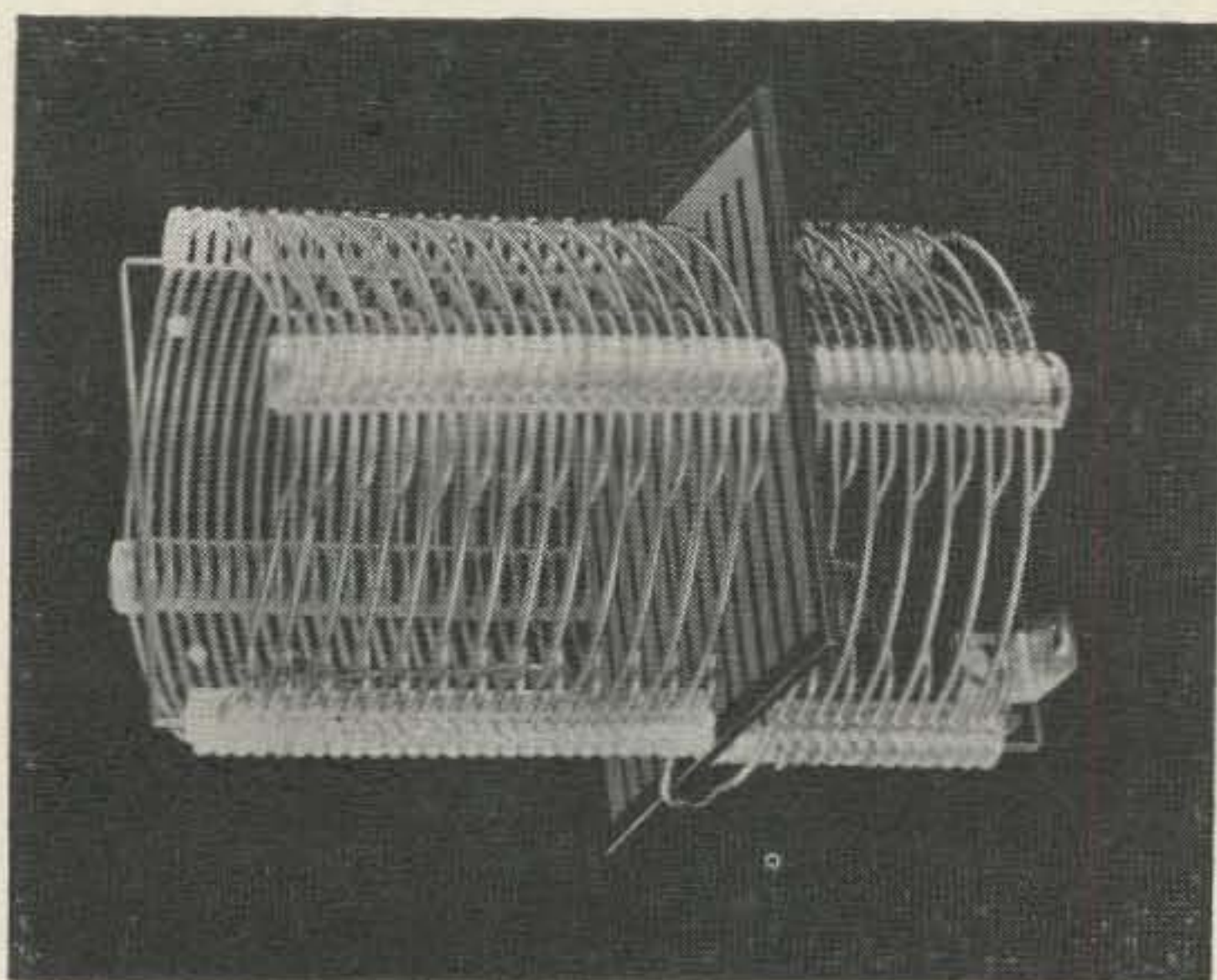

AIR FORCE MARS TECHNICAL NET

Sundays 2-4 pm edst 3295-7540-15715 kc
 June 4—Transistor Reliability.
 June 11—Advancements in Broad Band Communications.
 June 18—Space Tracking.

The Eastern Technical Net will recess until September 17th. Suggestions are requested from listeners as to next season's programming.

HAM SHACK NOVELTY

Authentic-looking, two-color certificate claiming tongue-in-cheek ownership of an acre on the Moon's surface. Ideal gift or conversation piece for shack, bar, den or office. (See Pg. 119—Jan. 61, CQ.) With gold seal and name and call inscribed only \$1.00 each. Six for \$5.00. Send check or M.O. to—

BOX DXG, 1738 — 201 St., Bayside 60, N. Y.

METER BARGAIN — 405 Microamp

1" Round Plastic Flush Mtg.

NEW — Original Boxes — \$2.25 prepaid

RITCO Box 156 Annandale, Va.

Safety-Efficiency



with a **CONTROLLED RELUCTANCE**

SAFETY-MIKE

\$ 19.50 NET

AT YOUR DISTRIBUTOR

or P. P. From Factory. Ohio Residents Add Sales Tax.

Plasticized stainless steel headgear and aluminum construction. Wt. under 3 oz. Imp. 1000 ohms at 1000 cps. Resp. 400-3000 cps. **CRF-3W** Net \$19.50



Matching unit for above provides -53 db to Hi-imp. TS-3 . . . installed Net \$3.00

Also available with carbon and crystal cartridges . . . mounted earphones, \$16.00 to \$29.50 net. Write for literature.

MOBILIERS

BOX 128 - 722 MAIN, COSHOCTON, OHIO PHONE MA 2-3731

Super Sensitivity for Two

Our aim, when we set out to produce the Tapetone Converters, was to make available to the DX-minded ham converters which until then could only be built by the ham with a machine shop and a lab full of gear. We made no compromises. Here are the specifications on our high-gain low-noise XC-144 converters.

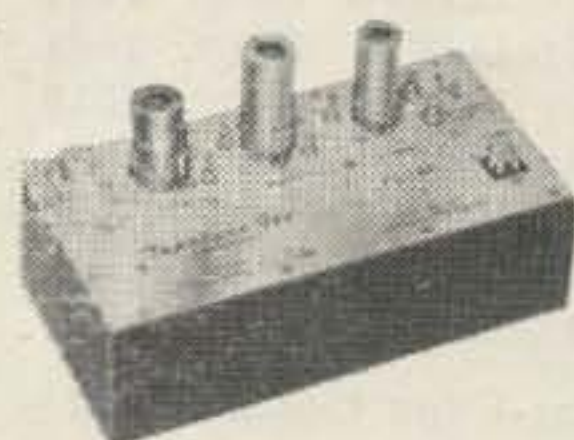

- **417A input! 6BQ7 Cascode; 12AT7 Oscillator; 6CB6 Mixer.**
- **Noise Figure: 2.8 db (with no advertising fudge factor.)**
- **Butler Oscillator for high stability.**
- **IF Tuning Ranges: 26-30 mc; 14-18 mc; 30.5-34.5 mc; 28-30 mc; 50-54 mc; 7-11 mc.**
- **Gain: 33 db. Image Rejection: 60 db.**

These converters are for DX-ing and not for use in high signal level areas.

Order direct from our Laboratory. Net price: \$75.00 plus \$7.50 Federal Excise Tax.

Matching power supply: \$45.00 plus \$4.50 Federal Excise Tax.

Converters for:

50—108—144—220—432—1296 mc

Send for a complete description of our many models and the latest price list. Prices have been reduced on all converters.

Club secretaries: write for details on our new club sales program.

TAPETONE 10 Ardlock Place
 Webster, Mass.

How to Build Your Own IBM* Machine

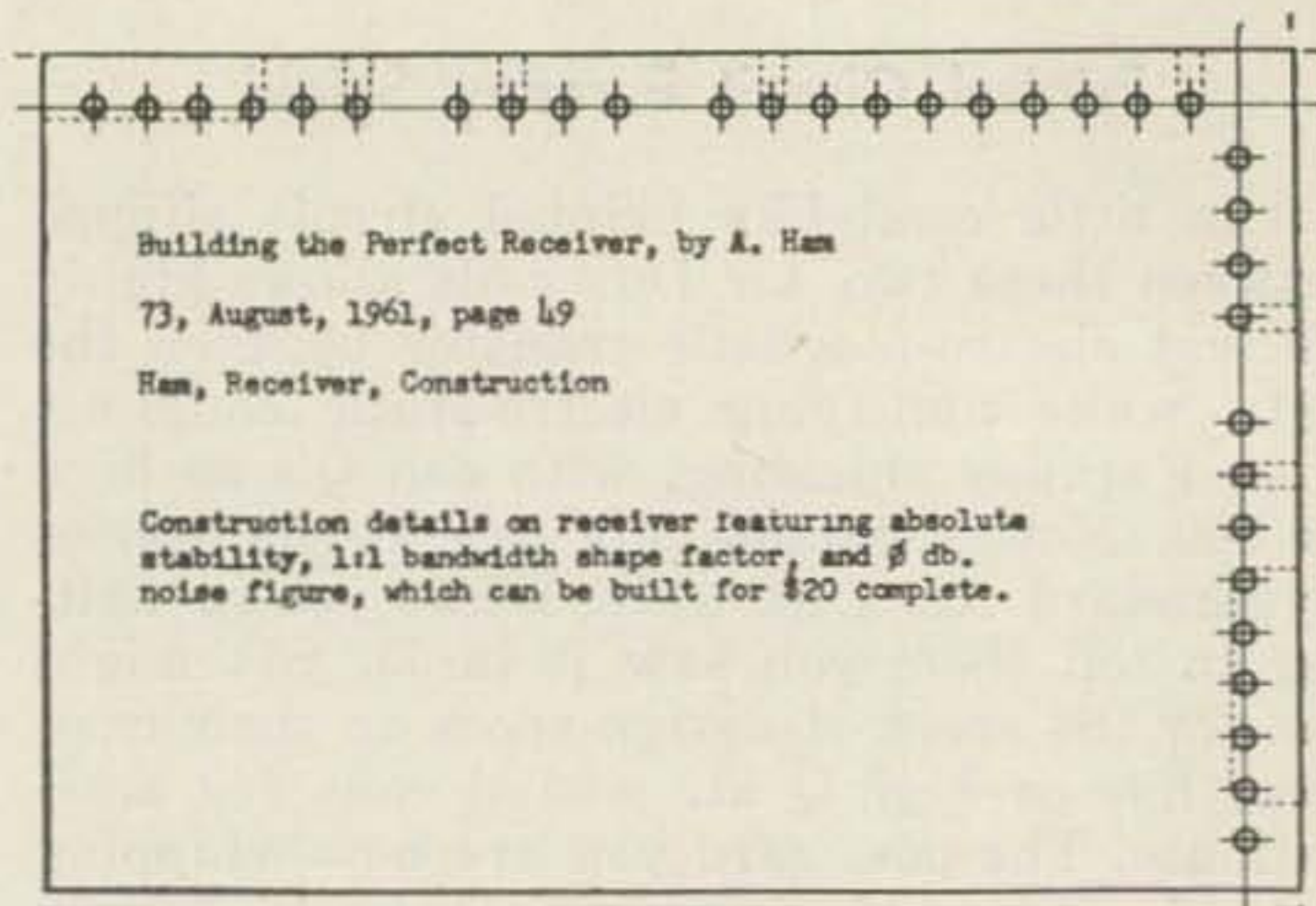

*Identification of Back-issue Magazine-articles

Do you need an IBM machine to keep track of your collection of radio magazines and

Top-Edge Coding (holes numbered from left to right)

1	2	3	4	5	6	7	8	9	10	11	12	13	14	15	16	17	18	19	20								
Year						Month				Author's Last Initials																	
1950	:	11	0	0	1	0	0	0	0	A	0	0	0	0	1	J	0	1	0	1	R	1	0	0	1	1	
1951	:	11	0	0	1	1	0	0	0	B	0	0	0	1	0	K	0	1	0	1	S	1	0	1	0	0	0
1952	:	11	0	1	0	0	0	0	1	C	0	0	0	1	1	L	0	1	1	0	T	1	0	1	0	1	0
1953	:	11	0	1	0	1	0	0	0	D	0	0	1	0	0	M	0	1	1	0	U	1	0	1	1	0	0
1954	:	11	0	1	1	0	0	0	1	E	0	0	1	0	1	Mc	0	1	1	1	V	1	0	1	1	1	0
1955	:	11	0	1	1	1	0	0	0	F	0	0	1	1	0	N	0	1	1	1	W	1	1	0	0	0	0
1956	:	11	1	0	0	0	0	0	1	G	0	0	1	1	1	O	1	0	0	0	X	1	1	0	0	1	0
1957	:	11	1	0	0	1	0	0	0	H	0	1	0	0	0	P	1	0	0	0	Y	1	1	0	1	0	1
1958	:	11	1	0	1	0	1	0	0	I	0	1	0	0	1	Qu	1	0	0	1	Z	1	1	0	1	1	1
1959	:	11	1	0	1	1	0	0	0																		
1960	:	11	1	1	0	0	0	0	0																		
1961	:	11	1	1	0	1	0	0	0																		
1962	:	11	1	1	1	0	0	0	0																		
1963	:	11	1	1	1	1	0	0	0																		

Right-Edge Coding (holes numbered from top to bottom)

1	2	3	4	5	6	7	8	9	10	11	12	13	Meaning
0	0	0	0	1									73
0	0	1	0										QST
0	1	0	0										CQ
1	0	0	0										Electronics Wd
0	0	1	1										Radio-Electronics
other combinations holes 1 thru 4													
	0	1											As desired
	1	0											ham radio
	1	1											hi-fi
			0	1	1	1	1	1					other
					0	1	1	1	1	1			Ham—Rcvrs
													Hifi—Amplifiers
													Misc—A thru E
					1	0	1	1	1	1			Ham—xmtrs
													Hifi—preamps
													Misc—F thru J
					1	1	0	1	1	1			Ham—Antennas
													Hifi—Turntable
													Misc—K thru O
					1	1	1	0	1	1			Ham—Test Gear
													Hifi—spkrs
													Misc—P thru U
					1	1	1	1	0	0			Ham—Misc.
													Hifi—Misc.
													Misc—V thru Z
										0	1		theory
										1	0		construction
										1	1		Product Report
										0	0		Misc.

Note: In top row, holes 11 through 15 are initial letter of author's surname while holes 16 through 20 are second letter of surname.

to enable you to locate that circuit you remember seeing last year but can't recall just where?

You do? Why don't you build yourself one?

Before flinging this copy of 73 out the window, read on a bit. We don't intend that suggestion as an insult or a sarcastic remark! The device described in these paragraphs is almost identical to the forerunner of the present office equipment—with the advantage that it's so simple anyone can build it on the kitchen table in one evening at almost no outlay in parts or materials.

Surprisingly enough, this gadget isn't electronic in any sense—it's purely mechanical. However, its basic principle of operation is the same as that used in electronic accounting machinery, so it can be useful in getting an idea of what goes on inside these machines as well as in solving your home-scale data-processing problems.

Materials you'll need to build the "73 Selector" are simple: a goodly stock of 4 x 6 filing cards. The tools are equally simple: a ticket punch and a razor blade (or scissors). To operate it after it's finished, you'll need a thin knitting needle or a length of No. 12 busbar smoothed off at each end.

Ready? Let's proceed.

First, take a look at the drawing which shows a blank card's hole layout. At this point, ignore the typing on the card and the dotted lines at some of the holes. The important thing is that 33 holes are punched on two edges of the card; they're shown as being on 1/4-inch centers with 1/2 inch between blocks, and located 3/8 inch in from the edge, but exact placement on the card isn't important. What is important is that the holes on each of your cards must align to within about 1/64 inch.

If possible, use some type of power punch to go through 100 or so cards at a time. This will assure perfect alignment. However, in the kitchen-table version, you can do it all by

(Go to page 46)

COLUMBIA GEMS!

WE BUY! BC-610, GRC, VRC, TS Equip. & parts! TUBES, etc. TOP PRICES PAID! What do you have?

APS-13 TRANSMITTER-RECEIVER
460-470 Mc. This is the "Tail-End Charlie"! 30 Mc.I.F. Less tubes. Good condition. Only **\$2.95**

SCR-522 TRANSMITTER. Good cond. Less tubes **\$3.95**
RECEIVER: 100-156 Mc. Good cond. Less tubes **\$3.95**

APX-6 TRANSMITTER-RECEIVER SPECTACULAR!
1215 Mc. **LESS TUBES** **\$3.95**
WITH TUBES **\$9.95**
Complete conversion data **\$1.50**

BC-375 100 W. TRANSMITTER
Ideal for domestic use, as well as export marine and mobile! Freq: 200-12,500 kc. with proper tuning unit. CW or MCW. Like new condition. Only **\$14.95**
ABOVE, but in good condition **\$9.95**
PE-73 DYNAMOTOR FOR ABOVE: Input 24 V. Output, 1000 V. @ 300 mils. W/filtering base. Like new **\$7.95**
Good condition **\$4.95**
TUNING UNITS: Each **\$1.95**

BC-620 XMTR-RECVR	LM FREQ. METER
20 - 27 Mc. Crystal controlled. WITH PE-120 POWER SUPPLY: that works on 6, 12 or 24 V. All brand new! Boxed. Special at	195-20,000 Kc. Het-erodyne type. Complete with original calibration book. Contains 1,000 Kc. Crystal! Excellent condition.
\$18.45	\$49.50

ARC-2 COLLINS TRANSMITTER-RECEIVER
2-9 Mc. 50 W. Xmtr. and Recv'r. Uses Collins PTO oscillator. Includes 22 tubes and 100 kc. crystal. Built-in 24 V. dynamotor. Compact, table-top unit. F.B. for marine, amateur, and mobile use. Excellent condition. Free schematic. **\$49.95**

BC-611 HANDIE-TALKIE CHASSIS
Assemble your own handie-talkie out of this completely wired chassis! (Less tubes, coils, acces.) Like new. **\$8.95**

ARR-15 COLLINS AIRCRAFT COMM. RECVR.
1.5-18 Mc. Features: 10 channel auto-tune PLUS manual tuning, 100 Kc. crystal calibrator, 13 tubes, 2 RF amplifiers; entire circuit premability tuned, 70E PTO oscillator, same as used in 75-A series receivers. Free schematic. Like new **\$49.50**

APN-4B MARINE LORAN RECV'R & INDICATOR
Gives exact fix in relation to Loran station. Works on 12 or 24 V. If you own a boat, this is the cheapest life insurance you can buy! BRAND NEW and BOXED. Only **\$79.50**
USED, but in excellent condition. Only... **39.50**

APT-5 UHF RADIO TRANSMITTER
50W. Uses 3C22 LIGHTHOUSE TUBE in tuneable 300-1400 Mc. cavity. Makes terrific rig for 432 Mc. ham transmitter, or hi-powered signal generator. F.B. for 432 or 1215 Mc. and ham use. Excel. **\$19.95**

NEW TRANSMITTING TUBES

4-65A \$ 7.50	4CX250B \$22.50
4-125A 19.95	4-400A 25.00
832 2.95	4-1000A 75.00
829B/3E29 ... 4.95	2C39WA 12.95

WRITE IN for new Bargain Bulletin!
All orders FOB Los Angeles. 25% deposit required. All items subject to prior sale. NOTE MINIMUM ORDER, \$3.00. WRITE TO DEPT 73

COLUMBIA ELECTRONICS

4365 WEST PICO BLVD. LOS ANGELES 19, CALIF.

UHF-VHF Beams

Just in time for the DX season. The all new J Beam UHF-VHF Skeleton Slotted Yagis — 50 m.c. to 450 m.c. Write now for information and prices. Quantities limited. **DON'T WAIT.** Available now for the first time in the U.S. A real quality antenna for the VHF man.

Look for K9EEC 2 meters with 6 over 6 slot
G4ZU Beams TELREX Beams
Rohn Towers CDR Rotors

Write now to

HOUSE OF ANTENNAS

1153 E. 82nd Street, Chicago 19, Ill.
Phone SO 8-9282

GO FIRST CLASS ON SIX

The LW-51
Deluxe

\$57.50



Features:

- 50 watts input, fully neutralized
- Uses inexpensive 8 mc xtals or VFO
- Plate modulated for efficiency and punch
- Input for crystal or carbon microphone
- TVI-proofed even in Channel 2 fringe area
- In kit form to cut costs
- All hard parts mounted (over 100)
- 6 or 12 volt filament
- Speech clipping & limiting for max modulation

Order Direct:

LW-51 Deluxe kit, less tubes & xtal	\$57.50
LW-51 Deluxe kit, with tubes & any xtal.	69.50
LW-51 Deluxe kit, wired & tested	84.50
Ship weight 7 lbs.: 77c East Coast; \$1.59 Western	
LW-72 AC Power Supply for LW51, wired	49.95
LW-61 VHF Converters	18.50
LW-80 Pre-Amplifiers	12.50

LW ELECTRONIC LABORATORY

ROUTE 2 JACKSON, MICHIGAN

TUBES WANTED!
ESPECIALLY KLYSTRONS,
MAGNETRONS, MINIATURE,
SUB-MINIATURE AND
OTHER SPECIAL PURPOSE TYPES
HIGHEST PRICES PAID

Jsh
ELECTRONICS CO.

DEPARTMENT
73
1108 Venice Boulevard
Los Angeles 15, California
Richmond 9-7644

(From page 44)

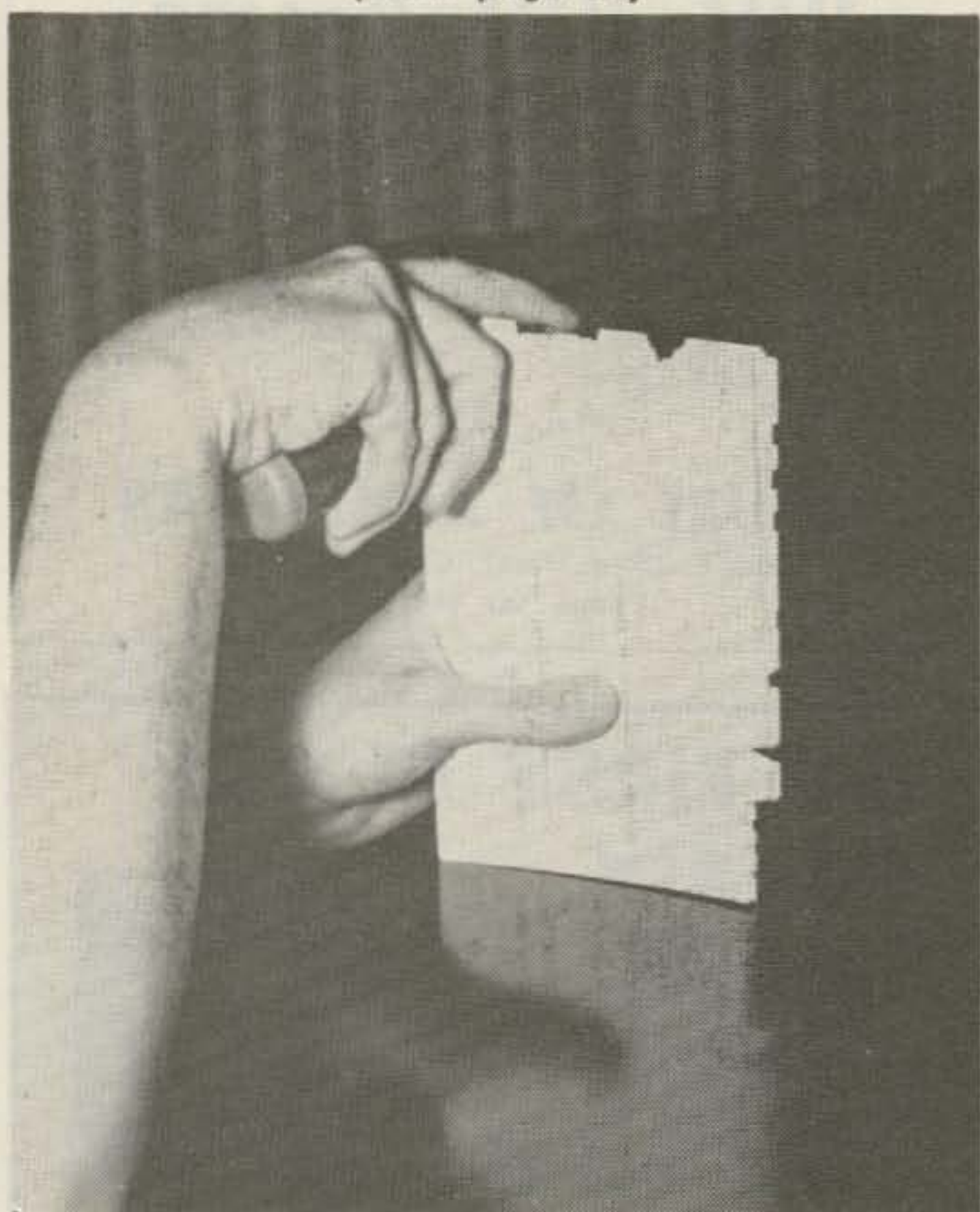

Sequence photos showing operation of "73 Selector." An awl is being used in place of the knitting needle, with small deck of cards which is listing for January and February 1961 issues.

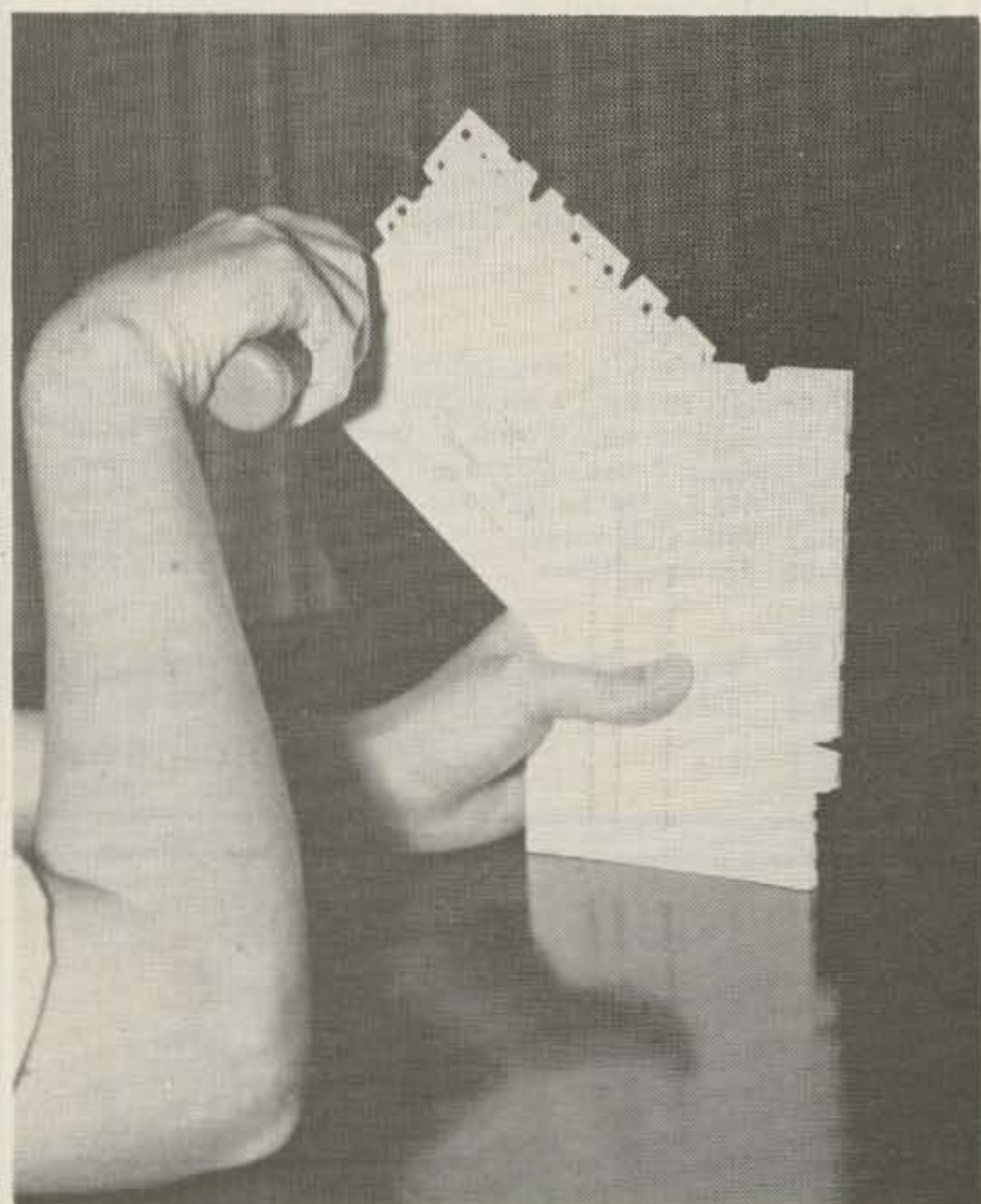

hand with the ticket punch. Just mark the location of each hole and be careful when punching.

At this point, you should punch all 33 holes on each card. Remember that you must have one card for each article you intend to list, and that every article in every magazine you have should be listed for the gadget to do

you much good.

When you've finished punching the blank cards, proceed to the next step; this consists of going through your stack of magazines and entering the information shown concerning each article, using a separate card for each listing.

The first line of the listing is self-explanatory. The second line lists magazine, issue, and page number. The third line—somewhat cryptically—shows the classification of the article, according to the various categories listed in Table 1. The final entry is simply a brief synopsis of the article, so you can tell later whether it is the one you're trying to find.

After filling in all the cards, you're ready for the final stage of construction. This consists of cutting slots from certain holes of each card to the border, leaving the card as shown in the photo. These slots, literally, are the keys to system success, because they make sorting automatic when you use the gadget.

Before cutting any slots, take a look at Table 1 (which we used earlier simply to get our categories). Note that each category is assigned a number which is made up of the digits 1 and/or ϕ , and also a specific group of holes.

An unaltered hole represents a zero in this code, while a slot is equal to a one. The notation is that called "binary," which is used in almost all computers.

As shown in the table, the row of 20 holes across the top of the card represents the year, month, and author identification of the article. The 13 holes down the side represent the magazine and the classification of the article.

Using table 1 as a guide, cut the holes away into slots as indicated by the classification categories and other indexed information. When you're finished, you'll have a deck of cards with ripply edges, and some will have holes where others have slots and vice versa.

At this point, you can relax. The work is over. All you need to do now is to use the file—and keep it up-to-date by making up new cards every time you get another magazine and adding them to the file.

To pick out all the articles dealing with any one category, simply use the knitting needle to lift the cards. An example will make it easier.

Let's suppose you want all the receiver construction articles which appeared in 73 during 1960.

To start with, use the first four holes from the top on the right-hand side to pick out the 73 cards. You do this by first aligning the cards, then running the needle through hole No. 4 of the entire stack. Turn the stack on its side and lift the needle vertically, joggling the stack at the same time. Some cards will fall away free, since they have slots instead of unbroken holes at No. 4 position. Included in these cards will be those for 73 (code 0001)

as well as those for Radio-Electronics (code 0011) and any other publications whose code ends in 1.

Put the other cards back in the file, and stack those which fell off. Run the needle through hole No. 3 and lift as before. Some will stay on and some will fall off. Since the 73 code is 0001, the desired cards this time are included in those which stay. Put the rest back in the file and repeat this process for Holes Nos. 2 and 1. The result will be that you have all the cards for 73 magazine separated from the rest of the file.

The next limiting category used in the example was the year, 1960. This information is carried in holes 1 to 6 at the top of the card. Using the code as a guide, repeat the stack-thread-lift process to pick out the 1960 cards. The sequence this time would be those cards which lift on hole 6, lift on hole 5, and fall on holes 4, 3, 2, and 1.

You now have remaining all the cards for 73's 1960 issues, which are still not what you were looking for—but what you want is included in them.

Repeat the process still once more, using holes 5 through 13 of the right-hand column, looking for the sequence 010111110. This means ham radio (01) receivers (01111) construction (10).

This time round, when you're finished, you
(Turn to page 48)

NEW FOR 144 MC!

"lit-line" (W6LIT) NUVISTOR CONVERTER



The Latest
in Nuvistor
Converters!

Check these outstanding features:

- NOISE FIGURE: 3db, Noise level so extremely low, the weakest signal can be heard.
- RF AMP. uses the 6CW4 grounded cath. amp.
- Input circuit is a 1/4 wave TUNED LINE inductively coupled to the antenna so as to maintain a high degree of selectivity (RF)
- 6EZ8 triple triode, mixer/osc/tripler.
- Total gain: Approximately 21db.
- Quality ceramic sockets and coil forms.
- Low pow. req.: 6.3V @580ma., 150V @15ma.
- Choice of 7 freq.: 7-11mc, 14-18mc, 26-30mc, 30.5-34.5mc, 28-30mc, 27-31mc, Novice calib., 28-30mc (145-147mc), 50-54mc, (HQ 170, HQ 110).
- WIRED, TESTED, w/tubes & xtal. \$29.95 Amat. net.
- Companion power supply \$15.50 net.



MISSION HAM SUPPLIES

5474 Mission Bl. PH. OV 30523 Riverside, Calif.

A Warehouse just full of clean surplus gear-UHF/VHF

Following is a partial list of units, parts, etc., on hand.

58A/ARQ-8 Receiver, 25-105 mc, less power supply & oscillator.....\$8.95

Watch 73 for a conversion article on this amazing unit.

2" Round Meters: 500 ma, 15 vac, 4 amp rf, 8 amp rf, 10 amp rf.....\$2.00

2" Square Meters: 1/4" thick flange: 150 vdc face, 0-1 movement.....\$2.00

3" Round Meters: 50-100-150-250 ma, 500 ma (0-1 movement).....\$3.00

ALSO! a UHF unit that converts "X" band to 60 MC with wave guides, two 723

A/B tubes, two 6j6—three 6AK5—a stepping relay, and other parts.....\$7.00 ea.

About fifty 740/740 at 96 mills (75 watt for novice final 807's) trans.....\$4.00 ea.

6V6, 6SN7 (unboxed surplus) new condition.....33 cents ea.

Custom/built two meter beams that w-o-r-k! five element.....\$11.50 ea.

Custom/built expanded coaxial antennas, very hot-low angle.....\$13.50 ea.

Compact "special" two meter xmmitter (2 watts into the ant)

This was described in eb. "73" excellent mod. less power, mike and tubes—\$18.00 ea. with tubes only \$25.00 ea. Uses xtal mike.

Can supply 220 MC xmmitters (like above units) only less output, same price.

Or if you want "6" meters, we can give these units. to you with almost four watts output—same price (as above).

Same deal as usual, on xtals—overtone for "2" and "6" and "220" MC range, box of eight for \$1.75 (all different).

Suggest you out of town boys (in California!) drop in and look over the many items on hand—priced to sell.

Hours: 9:00 till 8:00 — Sundays 11:00 till 5:00

Communication Equipment
Custom Built
Amateur Radio Equipment
Electronic Surplus

FULTON ELECTRONICS

2 Miles West of Manteca on 120 Highway

Phone TA 3-3717, Manteca, California

(Continued from page 47)

have the cards for all receiver construction articles which appeared in 73 in 1960—exactly what you were looking for.

The process sounds a bit tedious when explained in words, but after you've done it once you'll see that the entire thing can be done in less time than it takes to read a couple of sentences explaining how. The pictures show the three steps of a sorting run, using only a small deck of cards.

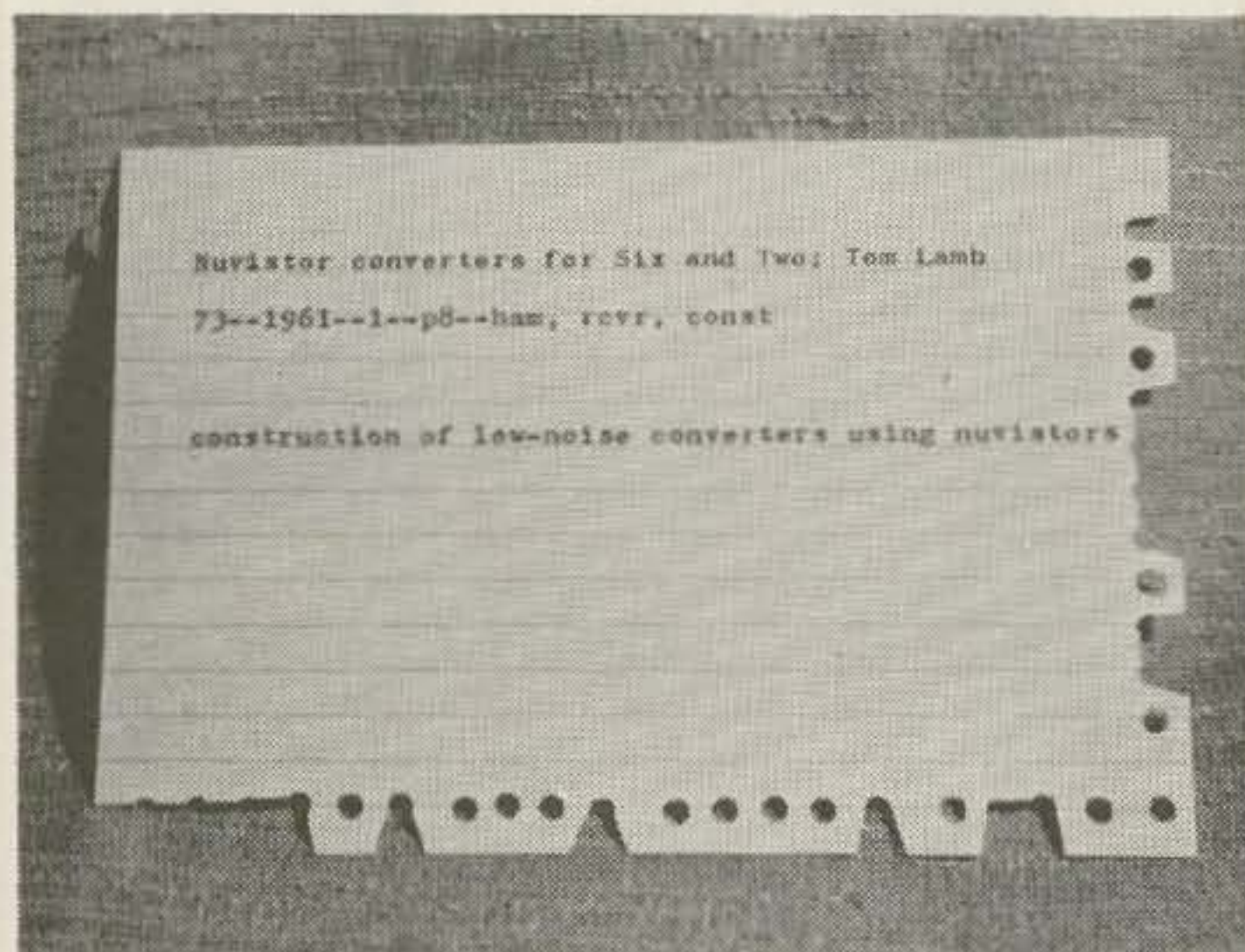

Card from the prototype "73 Selector." Note that holes shown on top in drawing and in text are on bottom in this set; this was first designed and by experience it was determined that cards would align more easily in file box if holes were on top. Codes for magazines and classifications were also altered slightly; however, any coding will work so long as it is consistent.

Here's how it works, if it hasn't become crystal clear to you yet. As you can see, a card will fall if it has a slot at the particular position used, and will stay on the needle if it has an unbroken hole. Any single hole position can be used for a two-answered question; however, a pair of hole positions can be used to mean four things:

A—code 00, both holes unbroken. The card stays on through both runs.

B—code 01, one hole and one slot. The card stays on the first time but falls away the second.

C—code 10, one slot and one hole. The card falls the first time but stays up the second.

D—code 11, both slots. The card falls away both times.

By assigning specific meanings to each code, you can recover that information from a scrambled deck by picking the order of the sort and the holes. For instance, to locate code 11, you would start with either hole, and after each sort the cards which stayed on the needle would go back into the file. The only ones kept out would be those which fell off both times.

On the other hand, to locate code 00, you would start with either hole, but the cards which fell off either time would be returned

to the file. All those which stayed on the needle both times would be kept.

This use of several positions of yes-or-no coding is the basis of electronic computers, which also employ the binary system. While it seems almost inefficient, remember that using 6 holes instead of 2 for one code group gives you 64 possible combinations—and 10 holes would give you 1,024 combinations.

Proper coding also makes it easy to put the file in order. Let's say you want it to be in alphabetical order by the author's name. This uses holes 11 through 20 across the top.

For this type of sort, you start with hole 20 and work back to hole 11. Keep the cards which fall free in proper order, and at the end of each sort put those which stayed on at the front of the stack, then sort again.

When you've sorted at all 10 hole positions, you'll find the entire file is in alphabetical order according to the first two letters of the author's surname. Here's why:

Let's suppose your deck has only four cards—one for Joe Jones, one for Q. X. Adler, one for Bill McNamara, and one for W. Green.

On the Hole 20 sort, only Jones' card would stay, since T, N, and R all have 1s in the hole-20 position. At hole 19, N and R would fall but O and T would stay. The order at this point would be: Jones, Adler, McNamara, and Green.

After the hole 18 sort, the order would be Jones, Green, Adler, and McNamara, since at hole 18 Jones and Green have Os while Adler and McNamara have 1s.

As the sort proceeds, the order changes each time according to the presence or absence of a zero in each card at that position. After the hole 16 sort, the order would be McNamara, Jones, Green, and Adler, and the second-letter sort would be completed. Holes 15 through 11 repeat the same process for the first letter, and after hole 13 the order becomes Adler, Jones, McNamara, and Green. At hole 12 Jones and McNamara fall, and when Adler and Green are brought to the front the order becomes correct.

In this example, since only four names were used, the sort was complete at hole 12. In practice, all 10 sorts must be made to establish proper order.

By the same token, the file can be sorted by magazine and then the sub-deck for each magazine can be put in order by month and year.

By now, you should have the idea of the do-it-yourself IBM Machine, our "73 Selector." Just two words of caution:

When you put one together, you're liable to find yourself thinking in binary code for a while—which may prove helpful if you ever want to work with computers—and

Watch out for the gadget. You may find it fascinating, and you *may* find it obsessing!

. . . K5JKX/6

(M-100 from page 22)

modulation of the full rf output. However, for best speech quality the modulation level should be set no greater than where the transmitter's plate current meter shows an apparent saturation point and further advancement of the modulation control does not increase the plate current. Because no reactive components appear in the modulator after clipping and because the dc coupling between V-3A to V-3B no filter is needed. The low output impedance of V-3B is in keeping with current practices in order to maintain good waveform and modulation linearity.

There are two typical situations in which the M-100 is applied. One is the clamped or regulated screen final amplifier operating in class C, which is illustrated by schematic diagram in Fig. 2, and the other grounded grid amplifiers using beam tetrodes or pentodes. In the case of the latter, efficiency would be greater through the use of the M-100 for screen modulation than with the grid modulated method commonly used. The manufacturer offers to consult with prospective users where they may have a problem concerning connection to and operation of their equipment.

In addition to tests made with home brew equipment, the M-100 was connected to a Viking Navigator which was kindly lent for that purpose by Chuck of Key Electronics in Arlington, Virginia, in order to try it out with a typical commercially designed rig in the hands of many Novices, as well as old timers, and to whom eventual conversion to phone would appeal.

(Now go to page 50)

B & W pi-network coils provide complete line

Model 851 \$16.50 Model 850A \$35.00 Model 852 \$39.50

Now—Pi-Network inductors specially tailored for your needs. Here are highly-efficient, super compact tank coils incorporating the unique feature of integral band switching.

Model 850A and Model 852, now complement the famous B&W Model 851. All are designed for single or parallel tube operation on 80, 40, 20, 15, 11 or 10 meters, with top efficiency in Class "C" or linear operation. Windings give ample current carrying capacity with optimum "Q" over the entire operating range.

See these superior B&W inductors at your dealers now, or write B&W direct for detailed information.

B & W *Barker & Williamson, Inc.*
Canal & Beaver
Bristol, Penna.

TELETYPEWRITER EQUIPMENT

COLLINS 51J2, 51J3, R-390A/URR Receivers (.50-30.5 MC)
TELETYPE Printers #14, #15, #19, #20, #26, #28.
KLEINSCHMIDT Printers #TT-4A, TT-76, TT-98, TT-99
TT-100, GGC-3.
TELEWRITER Frequency Shift Converter.

For general information & equipment list write:
Tom WIAFN

ALLTRONICS-HOWARD CO.
Box 19, Boston 1, Mass. Richmond 2-0048

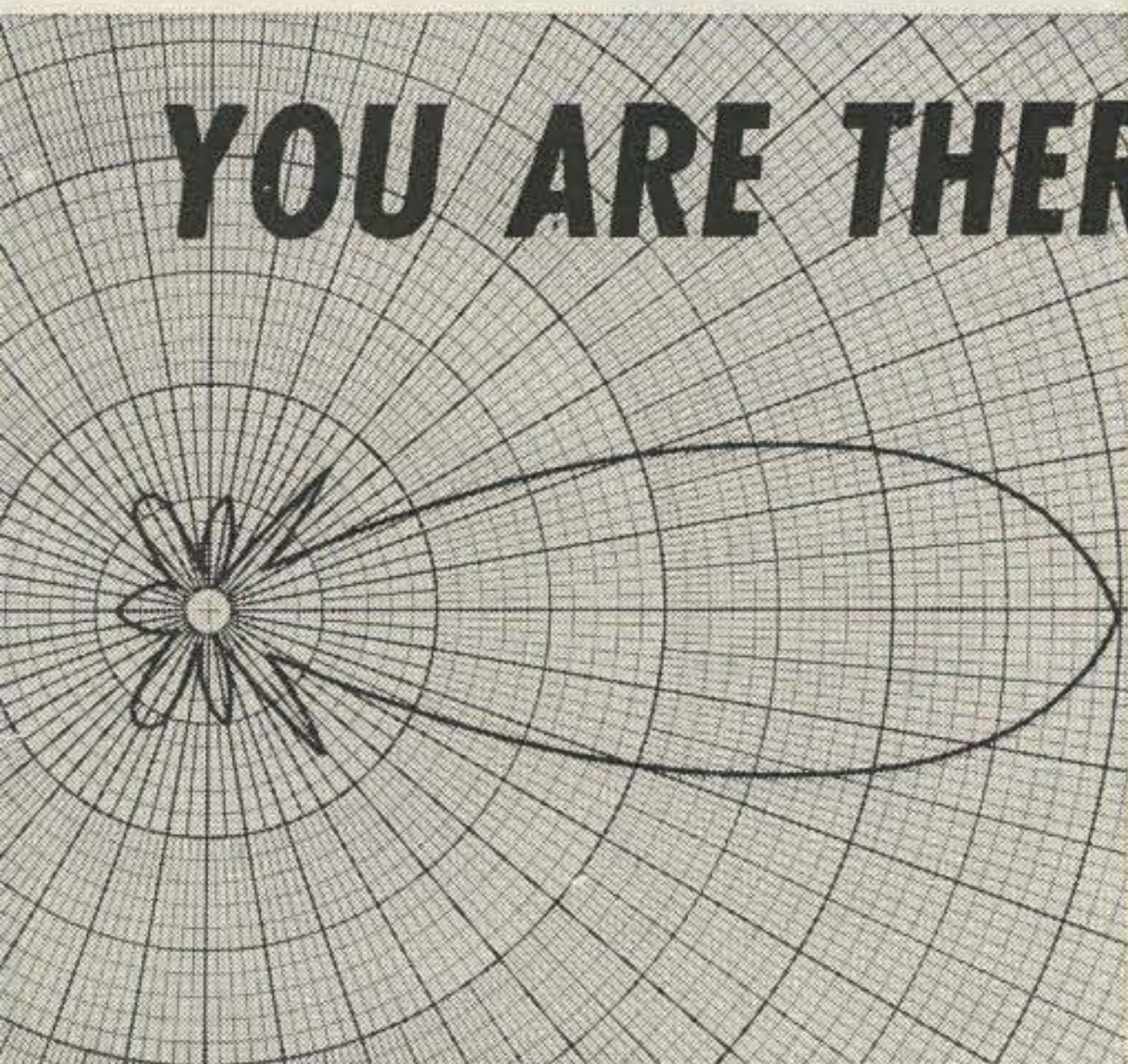

YOU ARE THERE!

with telrex
—"the-performance-line"—
with a "MATERIAL" difference!

Send for (or, at your distributor), PL 77 Technical Specifications and Performance Bulletin describing 106 Antennas from 3/4 through 80 meters including "BALUN"—FED ROTATABLE DIPOLES, MONO, DUO, TRI, 4-BAND AND "SPIRALRAY" ANTENNAS, ROTATOR/INDICATOR SYSTEMS, TOWERS, BROAD-BAND "BALUNS," ACCESSORIES AND "NICE-TO-HAVE-AROUND-YOUR-SHACK" INFO.

For TOP-MAN-ON-
THE-FREQUENCY results...
Install a Telrex antenna...dollar for
dollar better in every way! Antenna
systems from \$6.95 to \$12,000.00

ANTENNAS SINCE 1921 **telrex** LABORATORIES
Communication and TV Antennas
ASBURY PARK 40, NEW JERSEY, U.S.A.

"THE NEAREST THING
TO A PRIVATE TUTOR"

(ELECTRONICS ILLUSTRATED—JULY 1958)

CODE CONSTRUCTION

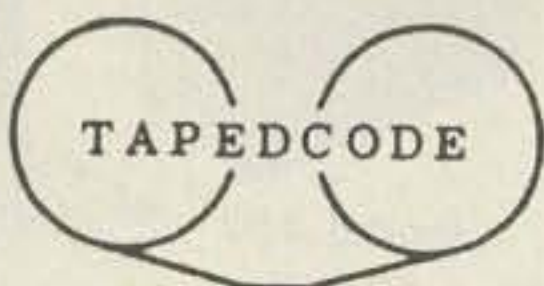

® **ONE OF THE
FINEST CODE
COURSES AVAILABLE**

Western Union, Railroad, Navy & Amateur
experience provided background for this course

**CONSIDERING THE RE-USABILITY OF THE
RECORDING TAPE THIS IS THE MOST IN-
EXPENSIVE COMPLETE CODE COURSE ON
THE MARKET TODAY.**

NOVICE TAPE—1 hour of basic instruction using
voice and code characters together and 1 hour of
practice material to 8 WPM\$6.50

ADVANCED TAPE—2 hours of practice material 9 to
18 WPM.....\$5.50

Practice material includes both plain language and
5-character coded groups, letters and numerals mixed.

Top quality Acetate tape, 1200' on 7" reels re-
corded dual track at 3¾ IPS.

A postcard will bring you the name of your
nearest distributor handling this fine product.

DISTRIBUTOR INQUIRIES INVITED

TAPEDCODE • BOX 31-S, LANGHORNE, PA.

(M-100 from page 49)

Step-by-step instructions for the hookup are furnished with the M-100. The only physical change of note is to insure the screen by-pass does not exceed 500 mmf and to replace it with one of that value where it does, as well as to open the screen dc lead at the socket, bringing these two connections to the M-100.

When on transmitter standby (receive) or tune positions, the audio from the loudspeaker would drive the screen of the transmitter through microphone pickup. This was cured by using a pair of auxiliary contacts of the antenna relay in series with terminal 4 of the M-100 so that this circuit is open on receive and closed on transmit.

The spectrum around the carrier when modulating was observed on a Panadaptor and looked clean at all settings on several bands. The modulation patterns were checked with a Central Electronics Multiphase RF Analyzer, and as may be expected, more precise adjustments of carrier and modulated envelope could be made. This is true of any modulated system. 'Scope monitoring of phone transmissions would clean up much of the smog of amateur radio, were it required by regulation. There was no difficulty in obtaining patterns equal to the perfect ones shown in the handbooks. If you do have or can borrow an oscilloscope

(Turn to page 52)

Watch for the Ashby "Abe Lincoln" Antenna by Hi-Par

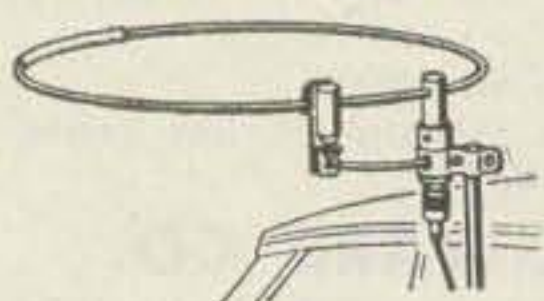

2-METER

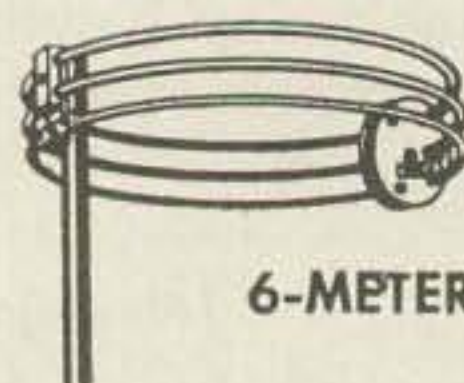

6-METER

HALO ANTENNAS

Fixed and Mobile, for both 6 and 2 meters, by the pioneers in horizontal polarization for mobile communications.

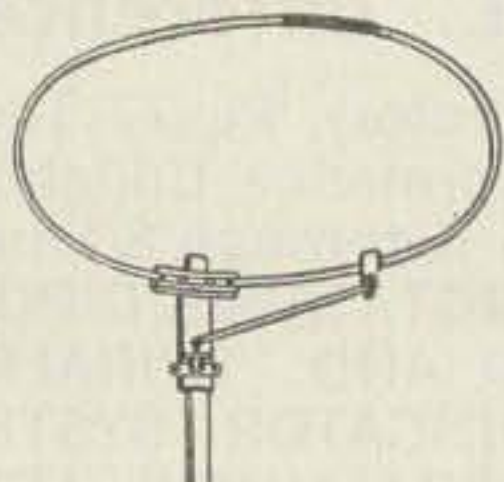

6-METER

Hi-Par also manufactures a quality line of antennas for amateur, TV, FM and commercial services.

AT YOUR
DISTRIBUTORS
OR
WRITE DIRECT

HI-PAR PRODUCTS CO. ♦ FITCHBURG, MASS.

Powerhouse Pros

Part I

While we're normally agin two-part articles, on the grounds that any technical information should be complete unto itself, this subject is an exception. The field of power supplies is a broad one, not often covered, and our choice was between giving you a power-supply article and nothing else this month, cutting

down the detail, or splitting the article into two parts. Rather than compromise the standards of our Technical Article series, we reluctantly decided to split the article. Part Two will appear next month—and either part is complete by itself; you don't have to wait until next month to use the information.

VACUUM tubes and transistors being the choosy gadgets they are, the power supply is a unit common to every item of electronic equipment. As a result, dozens of specialized power-supply circuits have been developed; however, the entire subject is usually disposed of with a few general words in most reference books. Few homebrew power supplies are engineered; the majority of them are simply put together and debugged until they work.

Happily, most of them *do* work—but they can be much more efficient and will accomplish their tasks more easily if they are designed before, rather than after, they're built. The basic principles are simple, and you probably know them already. However, many little tricks can be employed—and that's what most of this article is about.

Before going into the tricks, though, let's take a close look at those basic principles.

First off, we must decide on the purpose of a power supply. Naturally, it's to supply power. Most usually, this power is in the form of direct current, although most vacuum-tube power supplies include provision for low-voltage ac for tube heaters.

Output voltage may be high, low, or medium, depending on the application, and the same goes for current. A supply for a transistorized preamplifier may supply only 5 volts at 1 ma, while one for a kilowatt final may be called on to give forth 2,500 volts at nearly an amp.

Input to the supply is usually 115-volt, 60-cycle, single-phase ac from the house lines, but not always. Big rigs frequently use a 230-

volt input, and mobile units usually employ 6- or 12-volt dc. Mobile power supplies are a subject unto themselves because of their special considerations. They won't be gone into further in this article.

With input source and output power determined by the associated equipment and operating site, we can proceed to design a power supply. With so many specialized circuits to choose from, though, we're going to be lost unless we classify the circuits in some manner while examining them.

One method of classification would be into low-power, medium-power and high-power categories, and many references follow this procedure. However, many circuits are equally usable in either of these three groups, so we're taking a different approach. To start, let's decide whether we want to use transformers, or operate directly from the ac line.

Until a few years ago, transformerless supplies were limited to the low-power group because it was impossible to develop even moderately high power through multiplier circuits. However, modern circuit techniques make it possible to dispense with transformers at any level below about 500 watts output if we like.

While most references compare voltage multipliers with transformer-type supplies on the basis of comparative cost, that comparison loses validity in the higher power brackets since the amount saved on transformers is spent on additional rectifiers and capacitors. At lower power levels, cost comparisons remain

(Continued on page 62)

(M-100 from page 50)

or RF Analyzer, by all means do it. The attachment is very simple and observation educational. With the Multiphase, it is preferable to use its 1000 cycle tone fed to the microphone input in order to obtain sync. The .02 volt output should be used as higher levels would cause distortion due to the high gain of the M-100. Once the best settings for carrier and modulation is found, they remained constant for the microphone and plate current settings of the transmitter.

If you have no means of getting to a scope, satisfactory results can be obtained by following the operation instructions which come with the unit. There is a tendency to turn the gain up too high, therefore a critical on-the-air check is necessary in order to reach maximum clarity with maximum punch. Actually the M-100 hooks up much faster than it takes to talk about it, taking only about twenty minutes with the Navigator.

All on-the-air reports were good, even through heavy QRM on 20 meters in the evening, and most hams were surprised at the low power used while running the Navigator.

The brochure speaks of mobile use as a feature, and the M-100 would be ideal to modulate a high power mobile transmitter. It would be my preference to use a transistorized supply with a 115 volt 60 cycle output such as the Heath MP-10, which, while larger than necessary for the M-100 requirement of 30 watts,

could also operate a station receiver giving you a quick conversion from shack to mobile, and vice-versa.

The self-contained 1000 cycle tone source gives you ICW capability on UHF, as well as the tune-up source for double sideband suppressed carrier should the unit be reworked for that purpose. The bandpass was checked with a Supreme Model 563 Audio Oscillator, maintaining metered constant output and was in close agreement with the 300 to 4000 cycle range, having a sharper cutoff on the lower frequency side where 60 cycle hum troubles originate.

The general impression gained from operation of the M-100 is that it can find a place in almost any ham shack either as part of the main rig, for portable use or as the modulating source for anything you home brew or test. Many of the features available in the unit are those you would like to have but would not have the patience to incorporate in gear assembled for trial or test purposes.

... W4API

JIM CLARK * WTULU

KIT WIRING & TESTING LABS

REPAIRS & SERVICE ON ALL MAKES OF HAM GEAR
AND

TEST EQUIPMENT, CITIZENS BAND GEAR & HI-FI

2 Aiken St. Tel. HEmlock 2-3600 Derry, N. H.
ALL WORK GUARANTEED

Teletype Model TG-7 (Military version of Model 15) These machines are used but in good working order. Your cost \$150.00 FOB Long Island City N.Y.

RCA Receiver R-320/RC-88 This 14 tube Superhetrodyne receiver has a frequency range from 540 to 32,000 Kc. in six bands. This receiver designed for AM, MCW, and CW signals. One tuning control, RF gain, AF gain, Off, trans, receive mod-receive CW, Ant. Adj., Selectivity (Broad, sharp), Manual-Manual Noise Limiter AVC-NL, also phone jack on front panel. Complete with tubes 5-6SG7 2-6J5 2-6H6 1-6SA7 1-6K6 1-5Y3 1-6SQ7 and 1VR-150 plus rectifier. 456 kc. RF. Operates from 115/230 Volts AC 60 cycles. 19 1/4 X 11 X 19 1/4 Without cabinet, This unit fits nicely into standard table top rack. Weight approx 98 lbs. Used in checked out condition. Your cost \$160.00 FOB Long Island City N.Y.

Time Delay Relay 110 Volts AC Motor operated type Adj. 2 Sec. to 50 Min. Size 5 1/2 X 5 1/2 X 5 1/2 Westinghouse sold this unit for \$90.00 your cost \$6.00 Weight 7 lbs shipping. FOB L.I.C. N.Y. Brand new condition.....

Transformer Thordarsen Plate type 220 Volt primary Secondary 3000 Volt CT at 300 mills, conservatively rated, you can pull more juice out of this one, your cost \$17.95 Shipping Weight 69 lbs. FOB L.I.C. N.Y.

Radar Scope indicator.... Model 9P-183/BPS-4 Range Indicator Useful for foundation for lab scope or other experiments. Input is 115 Volts 60 cycles It contains it's own High Voltage power supply and filament transformer for the Indicator... You just have to add B plus power into this unit to fire it up. Contains the following. 6SN7 Trigger Amplifier, and negative gate multivibrator. 6AG7 positive Gate multivibrator, 6SN7 Gate cathode follower and sweep generator, 6SN7 Sweep amplifier, 6H6 DC Restorer, 6AC7 First video amplifier, 6AG7 second video amplifier, 6SA7 Phantastron, 6SN7 Phantastron cathode follower and diode, 6AC7 step amplifier, 6SN7 step sharpener, 3B24 High Voltage Rectifier..... Shipping Weight Approx.. 140 lbs. Brand new condition Your cost \$38.95

Crystal Type CR27/U Frequency 28.55556 kc. This crystal is in the 10 meter phone Band, swell for a net frequency.... Your cost \$1.95 Weight 6 oz...

We do appreciate your name on a post card for our mailing list.. Best 73

SPERA ELECTRONIC SUPPLY 37-10 33 Street Long Island City N.Y. De W2LBU....



TG-7

SPERA ELECTRONICS

37-10 33rd Street
Long Island City
New York, N. Y.

de W2UFU

R-320/RC-88





Model M-100

New Self-Contained Universal Series Gate A.M. Modulator

**JOIN NOW THE CIRCLE OF ENTHUSIASTIC OWNERS!!!
EASILY ADAPTABLE TO MOST COMMERCIAL CW TRANSMITTERS.
AN IDEAL MODULATOR FOR THE HOMEBREW TRANSMITTER.**

- Modulates any beam tetrode or pentode amplifier up to 1 KW
- Extremely economical and efficient method of modulation
- No sacrifice in CW power capacity
- Amazingly small: only 6" x 7 1/2" x 5 1/2"
- Two years complete guarantee

Find out for yourself why the M-100 is your best ham investment per dollar:

Order Today . . . \$59.50 Net

10 DAYS TRIAL, MONEY BACK GUARANTEE

Write for complete technical information. Send check or money order to:

ELECTROTONE LABORATORIES, INC.

1713 North Ashland Avenue

Chicago 14, Illinois

MORE ABOUT OUR COMPLETE LINE OF NUVISTOR PRE-AMPLIFIERS

Notice in our photo the high quality of components used:
High Q ceramic slug tuned coils for 50mcs and 144mc output.
High Q glass capacitor and silvered coils for 220mcs, 432mcs and 144mc input.
High quality 600vdc ceramic coupling capacitors.
Power filter capacitors effective from DC to 2KMC.
Drawn enclosure to meet the most rugged commercial requirements.

**"ALL THIS WAS DESIGNED TO GIVE YOU HIGH PERFORMANCE
AND LONG TERM RELIABILITY"**

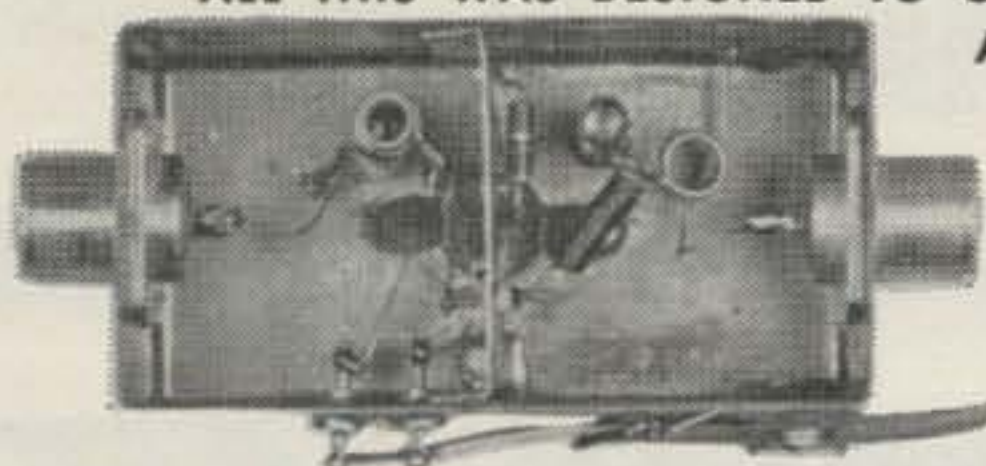

\$19.95

BULLETIN E-5124



CIRCUIT FEATURES:

1. Complete R.F. shielding from input to output. 2. Flanges of R.F. connectors soldered on inside. 3. Solder sealed cover. (Enables us to give you a complete written guarantee.) 4. Total power drain only 1.4 watts. (A natural for mobile installations.) 5. Units can be supplied with resistors and inter-connecting cables for installation into any commercial-amateur receiver. 6. Choice of R.F. connectors available upon request (slight adjustment in price).

"ADD OUR PRE-AMP TO YOUR PRESENT RECEIVER AND EQUAL FEATURES FOUND IN SOME OF THE MOST EXPENSIVE LINE OF COMMERCIAL CONVERTERS" Here are some guaranteed specifications:

MODEL	FREQUENCY	BANDWIDTH	NOISE FIGURE	POWER GAIN
G-50	48 to 60mcs	3mcs (3db points)	2.5db	20db
G-144	140 to 150mcs	3mcs	3.0db	20db
G-220	210 to 240mcs	3mcs	4.0db	20db
G-432	410 to 450mcs	5mcs	6.0db	20db

No advertising fudge factors, plain honest to goodness facts!

SPECIAL! this month only higher noise figures (less sensitivity) \$13.90
Nuvistor pre-amplifier with automobile connectors and

We also manufacture the famous "PERSEIDS" 417-A grounded grid pre-amplifier featuring high input selectivity through the use of double tuned input coils (greater rejection of unwanted signals outside the pass band) in reality a built in R.F. matching transformer. This unit also features high sensitivity. \$21.95 less tube; \$39.90 with tube. Write for bulletin E-50144.

VHF-UHF

Next month! The "LYRIDS" Directional Power Coupler 4 Instruments In One
ASSOCIATES

P.O. BOX 1068

FAIRFIELD, CONN.

PROPAGATION CHART

EASTERN UNITED STATES TO:

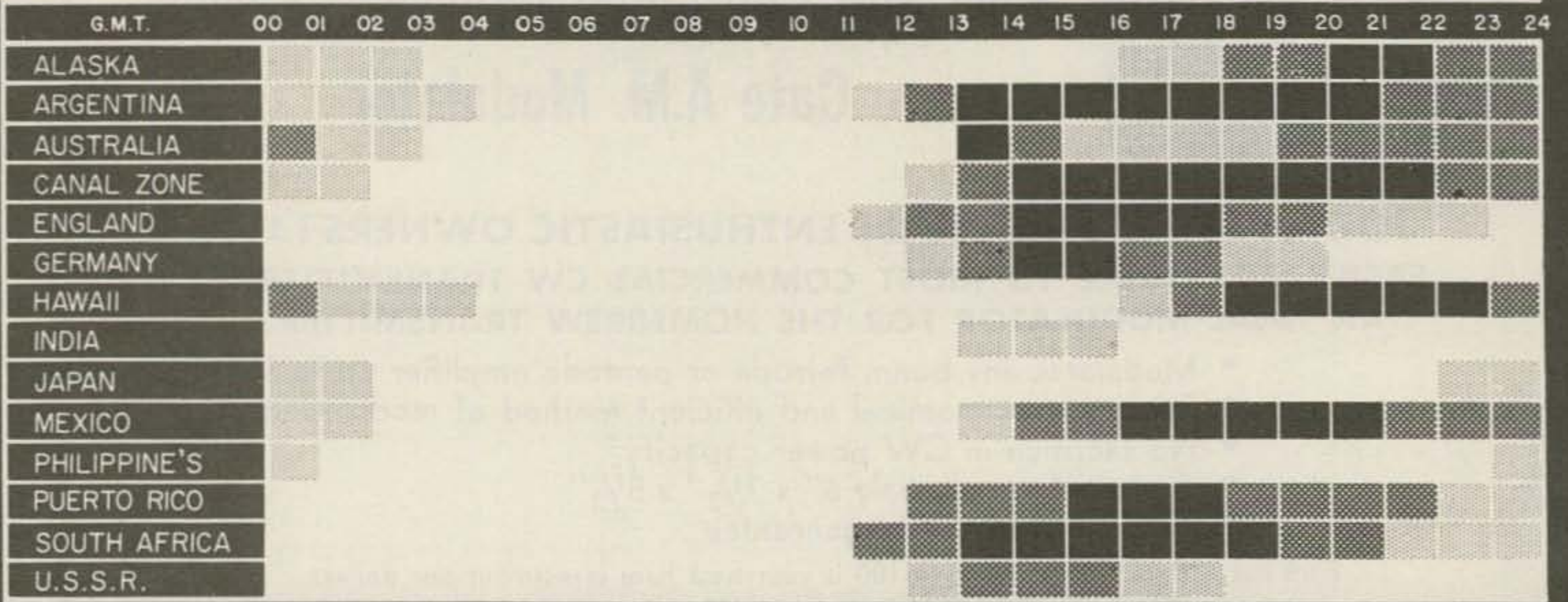

CENTRAL UNITED STATES TO:

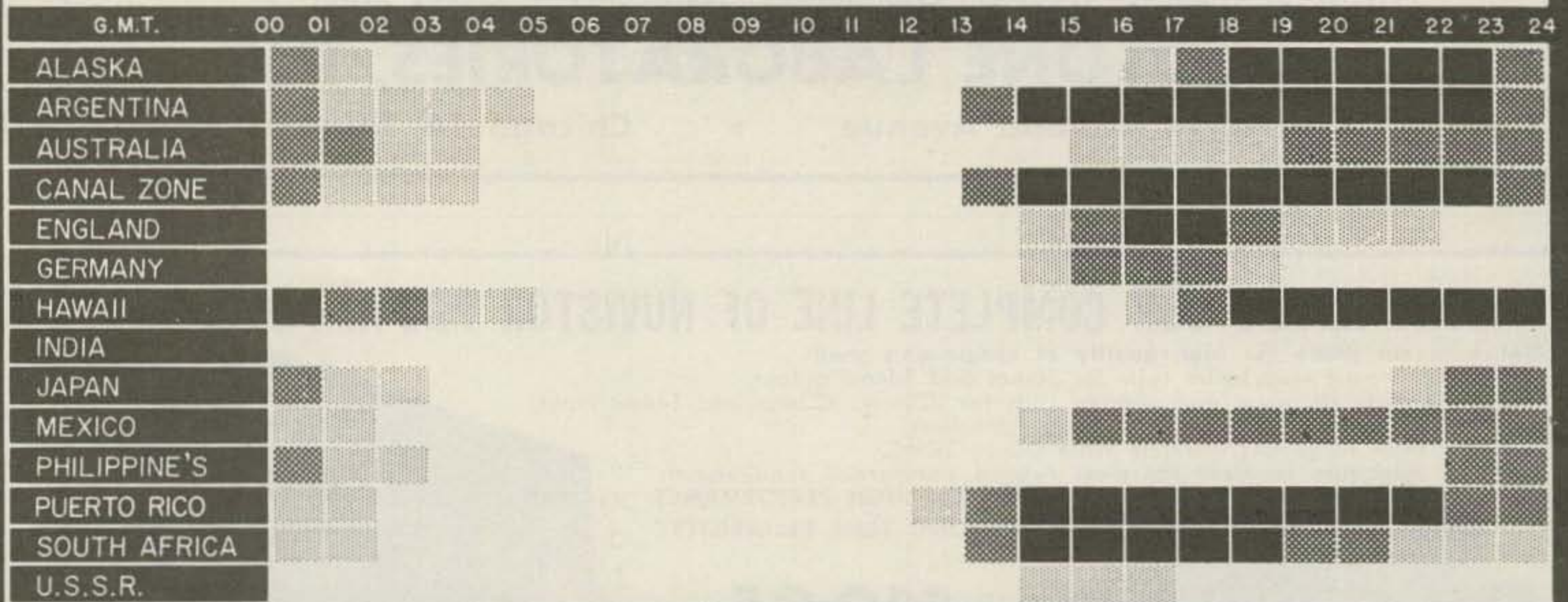

WESTERN UNITED STATES TO:

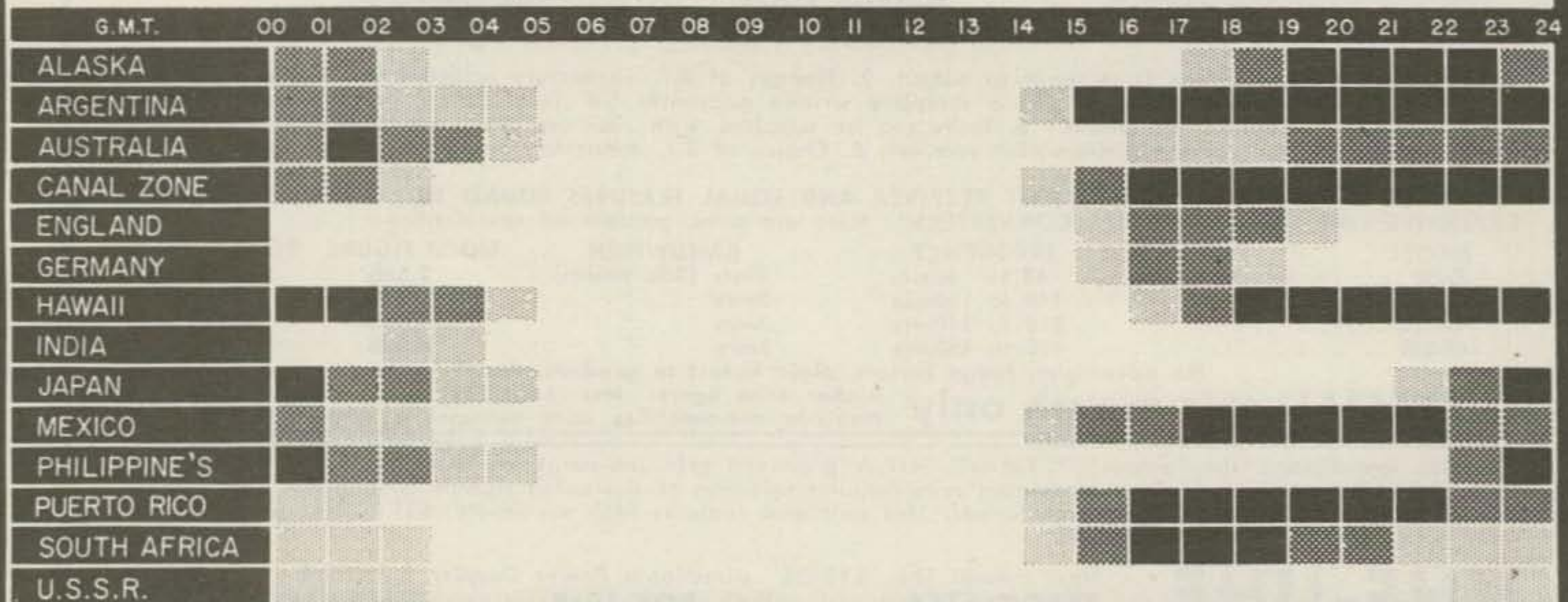

LEGEND

7 MC

14 MC

21 MC

28 MC

Propagation Charts

David A. Brown K2IGY
30 Lambert Avenue
Farmingdale, N. Y.

The bands listed are MUFs and a higher band will not work for the time period listed. Lower bands will work, but not nearly as well. Times are GMT, not local time.

These charts are to be used as a guide to ham band openings for the month of June, 1961 to the various countries listed. I will be interested to hear of your results in using these charts and to know what other areas you might wish included in future charts.

Advanced Forecast: June 1961

Good 1-2, 4-7, 15-30

Fair 3, 8-9, 13-14

Bad 10-12

REMINDER

Bring this copy of 73 to your next ham club meeting and let everyone see it. Don't forget to show it to hams that come avisting too. We have been able to get special U. S. Government permission (our postman says OK) for you to discuss articles appearing in 73 with fellows on the ham bands.

Need Drafting?

Our drafting department needs a little more work to do in order to keep it out of mischief. If you have need for any professional drafting of circuit diagrams, layouts, etc., then drop us a line. We'll even put together brochures and booklets. 73 Production, 647 Eighth Avenue, New York 36, New York.

NEW AMECO NUVISTOR PREAMPLIFIER



for 50, 144 and
220 Mc. bands
Lowest Noise
22 DB Gain

\$13⁹⁵

wired and tested

Add an Ameco Nuvistor Preamplifier to your converter or receiver to improve the noise figure and gain. Image and spurious rejection will also be improved as the Model PV has two tuned circuits. Compact, easily connected, low power requirements.

Model PV with tube, wired and tested.

State which band\$13.95

For any band, 80, 40, 20, 15 or 10 meters, the Ameco Model PH Preamplifier has a better noise figure than most multiband receivers, 23 db. minimum gain, will improve image and spurious rejection with its two tuned circuits. Especially effective on 10 or 15 meters.

Model PH with tube, wired and tested.

State which band\$13.95

Write Dept. 73-6

AMERICAN ELECTRONICS CO.
178 HERRICKS ROAD, MINEOLA, L.I., N.Y.

IN THE ... WEST - it's WESTERN RADIO

and TELEVISION
SUPPLY
CO.



FOR OVER 25 YEARS ONE OF THE WEST'S OLDEST AND LARGEST FIRMS
DEVOTED EXCLUSIVELY TO AMATEUR AND ELECTRONIC EQUIPMENT.

1331 India St.
P. O. Box 1728

San Diego 1, Calif.
BELmont 9-0361

6 Meter Antennas

3 ELEMENT BEAM \$13.95
 Model #A50-3 Boom 6' x 1 1/4"
 5 ELEMENT BEAM \$19.50
 Model #A50-5 Boom 12' x 1 1/4"
 6 ELEMENT BEAM \$32.50
 Model A50-6 Boom 20' x 1 1/2"
 10 ELEMENT BEAM \$49.50
 Model #A50-10 Boom 24' x 1 1/2"

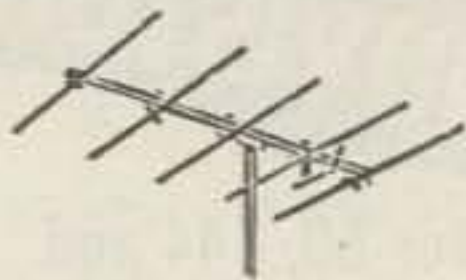

STACKING
 KIT
 AVAILABLE

SEE YOUR DISTRIBUTOR
 —or write for Free Catalog.

CUSHCRAFT

621 HAYWARD ST.
 MANCHESTER N. H.

Reyco Multiband Antenna Coils

Traps for dipoles . . . high strength . . . moisture proof guaranteed to handle a full KW.
 Model KW-40 coils will, with a 108 foot antenna, provide operation on 10-15-20-40-80. \$12.50 set.

For information on other models write:

FRED L. REYNOLDS W2VS, 492 Ravenswood Ave.,
 Rochester 19, New York

BOSTONIANS!

WHAT'S NEW!—Why Collins is—at Bob Graham's stores. Now we have them all—Collins, National, Hallicrafters, Hammarlund, Gonset, Johnson, C. E. Drake, etc., etc. See us for the best deal in ham equipment both new and used. We buy, sell, trade, rent, install, and service.

GRAHAM RADIO INC.

505 Main St., Reading—Tel. 944-4000
 1105 No. Main St., Randolph—Tel. WO 3-5005

MOBILE POWER SUPPLY

MODEL
 A12/600/200

NOW
\$59.50

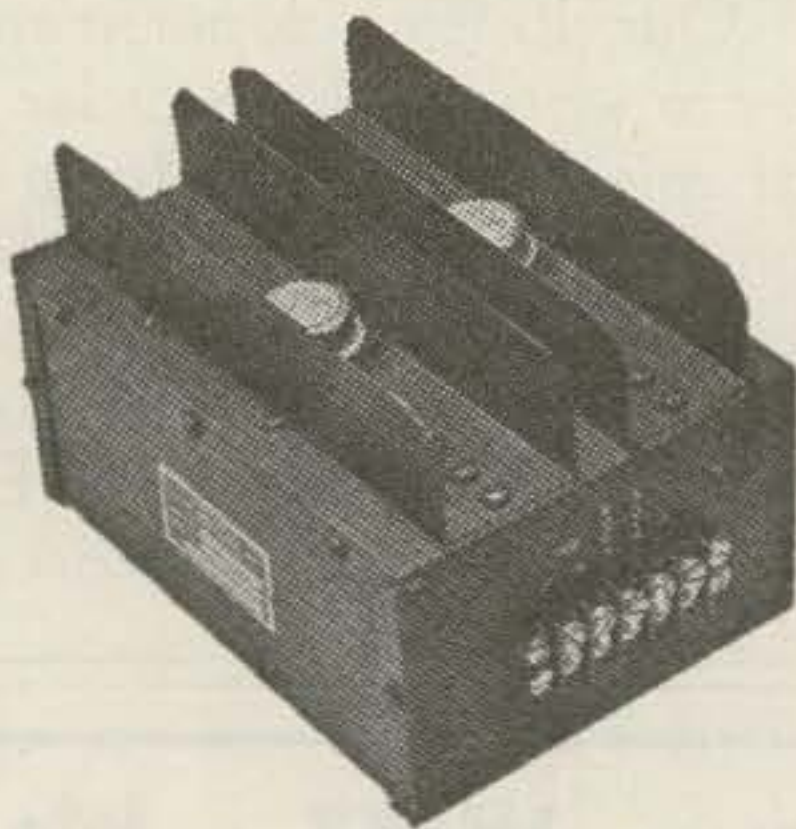

This 12V input dc to dc transistorized converter is conservatively rated for continuous output of 120 watts at 600V or 300V, or any combination of 600 and 300 volt loads totaling 120 watts.

High efficiency, small size, and light weight, plus freedom from maintenance, conserve your battery and increase the enjoyment of mobile operation.



ELECTRONICS DIVISION
GLOBE INDUSTRIES, INC.

525 MAIN STREET
 BELLEVILLE, NEW JERSEY

The Dx

"LEMMIE tell ya', boy," old Rufus Jones said to me one afternoon, "there ain't nothin' what's more fun than huntin'. They's fun in gettin' yore huntin' gear ready. They's fun in settin' an' watchin'. They's fun in raisin' yore gun an' pullin' th' trigger. They's even fun when you open both yore eyes an' fine you plumb missed th' varmint you was aimin' at. But mind you, boy, it takes a heap o' figurin' and patience for you to be a good hunter."

Although old Rufus had coon and squirrel in mind when he was talking, his comments can be very aptly applied to the hunting of that elusive quarry, dx. Dx hunting can be fun and the number of hams who indulge in this facet of amateur radio certainly prove it. Experience has taught the old timer the signs and trails that lead to successful dx contacts. The new ham with the dx fever in his blood is very often confused and unsure as to how to start adorning the walls of his trophy room with those rare QSL cards that result from successful dx hunts.

First, let's give some attention to what old Rufus would call "huntin' gear." For one thing, high power is not a necessity. Many fellows have and will continue to work the rare ones using less than one hundred watts. The antenna is very important and should be the most efficient possible for your location. This will enable you to hunt with the biggest signal possible for the power you run. As for the receiver, forget about the chrome and icing. If you have one that's both sensitive and selective, who cares how fancy it looks.

Now that you've got your "huntin' gear," where to hunt is the next question. That's easy! If you look in a copy of "73" magazine, you'll find a "hunter's almanac" that Wayne calls a "Propagation Chart." A little study of this chart will tell you when and where to hunt and what for.

After you've got your gear warmed up and you're tuned up in "huntin' territory," the "sittin' and watchin'" begins. Don't get impatient! A deer doesn't jump out of the brush the minute you sit down and cock your gun. It's the same with dx. Assuming for the mo-

Hunter

Ken Johnson W6NKE

ment that you're on cw, tune slowly up and down the band. Listen carefully to the weak signals and don't ignore the strong ones. That S9 signal you just passed could be a rare one with a skip "pipe line" right into your location. Listen, listen, then listen some more. No doubt you'll hear some of the fellows calling cq dx and get the yen to try it yourself. The chances of raising a dx station in this manner are small. The law of averages is agin' it. In addition, it creates QRM for the other fellows and you could easily be on top of a rare one and louse things up for them. More than once, I've had a good dx contact ruined through someone calling cq dx right on the frequency.

When you do hear a choice one, twist the dial on your VFO and zero in on his frequency. When he signs, call him and be sure that your first is good, clean and easy to copy. Don't call his call too long, three or four times and the same with yours, is plenty. Take a listen and tune a little each side of the frequency. Either he, your receiver or both might have drifted slightly. If he doesn't come back, call him again. Keep up these short calls and listening periods until he does come back to someone or calls cq again. Don't give up, call him again in the latter case. If there are several other stations taking a shot at him too, keep after him. You've always got a chance until he comes back to someone.

If another station nabs him, either stand by and wait for him to finish his QSO or hunt elsewhere on the band. Don't try and break in on a dx QSO. Many dx stations will refuse to recognize or come back to a station that tries to break in on their contacts. Wait until he finishes his contact and call him again. It may take two or three standbys but with courtesy, persistence and patience, you've got a good chance of bagging him.

When you make a good shot and get a contact, keep your transmissions short and match your speed to that of the other operator. Over long distances, the band conditions can change in the twinkling of an eye. By keeping transmissions comparatively short, you lessen the

(Turn to page 58)

NEW P & H LA-400-C LINEAR AMPLIFIER NOW 800 WATTS PEP FOR ONLY \$164.95



PANORAMIC SPECTRUM ANALYSIS

Odd order distortion products (1kc, separation) using popular 100 watt SSB exciter and LA-400C.

	3rd order	5th order
EXCITER ONLY	-37 db.	-47 db.
EXCITER AND LA-400C	-37 to -40 db.	-47 to -50 db.

Certified by ITT FEDERAL LABORATORIES

The 80 thru 10 meter band-switching pi network is designed for 800 watts PEP SSB, 400 watts CW, FM or FSK and 230 watts Linear AM (controlled carrier) or 185 watts (constant carrier) with 50-70 ohm output. Popular 100 watt SSB exciters require no swamping or matching networks to drive the low Z untuned input. Grounded grid circuit uses four 1625's or 837's on customers request. Meter reads RF drive, plate current, RF amps output. New modern compact 9" X 15" X 10 1/2" gray cabinet also contains power supply using 816's. TVI suppressed, Parasitic Free.

One-Year Warranty on all Parts and Tubes

SEE THE NEW LA-400C AT YOUR DEALERS

LA-400C Kit Complete with tubes\$164.95

LA-400-C Wired and tested\$219.95

P & H ELECTRONICS INC.
424 Columbia Lafayette, Ind.

GENERALIZE YOURSELF! LEARN RADIO CODE

The EASY WAY

No Books To Read—No Visual Gimmicks To Distract You. Just listen and learn

Based on modern psychological techniques — This course will take you beyond 13 w.p.m. in

PRICE \$9.95 LESS THAN 1/2 THE TIME

See Your Dealer Now!

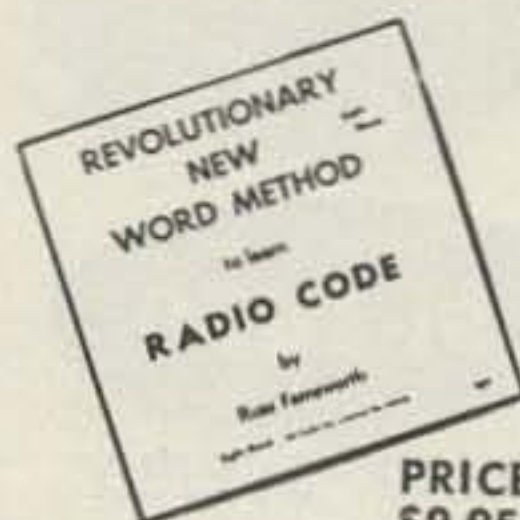

Album Contains Three 12" LP's 2 1/2 Hr. Instruction

EPSILON RECORDS

2769 CAROLINA REDWOOD CITY, CALIF.

U.S. #1 ELECTRONICS

a division of Amber Industrial Corporation
 1920 E. Edgar Road Linden, New Jersey
 Right on Highway U. S. 1
DROP IN FOR OUR SATURDAY SPECIALS
PLENTY OF FREE PARKING

Send for our **NEW FREE Catalog**
 featuring special buys from one of the largest
 surplus collections in the East.

BC-659 BC-1335

Small FM transceiver for 27.0-38.9 mc. Xtal controlled on either of two pre-tuned channels. Carbon mike input, headset output. 4.3 mc IF. Self-contained 6/12 volt power supply. Converts to AM for 6 or 10M. Only 15" x 14" x 7". 30 lbs. Great for mobile. Up to 4 watts output. Used, but very good condition \$10.95

BC-1158

53.3-95 mc transmitter. Easily converts for 6M. 50 watt RF doubler. Four 815's. Complete with modulator. Brand new units \$34.95

SCR-522

4 channel crystal controlled AM transceiver. One of the most popular pieces of surplus ever sold. Thousands have been used on two meters. In excellent condition, complete with PE-94 power supply (24v) and control box \$22.50

VRPS-1 POWER SUPPLY

Here is the dynamotor for that 30-50 watt mobile rig. 12v @ 13a input, 300v @ 225 ma and 250v @60 ma regulated output. Completely filtered and fused. 3 relays, 2-VR105's, 1-VR150. 11½" x 8" x 8" in metal case. Brand new. \$14.95

Thousands of Items—Thousands of Bargains

25% deposit on COD orders, all prices FOB Linden, N. J. Some quantities limited. Prices subject to change without notice.

And don't forget our free new catalog!

(From page 57)

chances of losing the contact during band changes and fluctuations. When the QSO is finished, move off the frequency and let another station have a chance.

Working dx on AM phone is a different proposition. Many of the dx stations operate in the cw portions of our ham bands, so it is impossible to zero beat their frequency. The system in this case is to tune up near the low frequency ends of the American phone bands and call them from there. The closer you get to the edge of the band, the more QRM you will encounter. It's like opening morning of deer season. Every hunter is down there aiming at the comparatively few dx stations available. Even if you are putting in a good signal at the distant location, yours is probably one of many and the QRM is terrific. It's a good idea to tune up on a frequency considerably above the low edge of the band and call from there. Some dx operators actually tune from the top of the American phone bands to the lower end hoping to get a call from some station that's operating above QRM alley. I've had them thank me for calling from such a spot as they haven't been able to make out a word through the QRM near the lower edge. Try it, it works.

You, like everyone else, want a QSL to prove the success of your hunting forays. Here's another hunting tip that gets results. When you send your card, put it in an envelope, enclose a self-addressed, envelope and as many IRC's (International Reply Coupons) as necessary to cover the return postage. These can be purchased at any U. S. Post Office. Help the dx operator and yourself by sending your card in this manner. Then have patience and wait! Put yourself in the position of the operator of a dx station. Nearly every station he contacts wants a QSL. It costs him money to have the cards printed, the volume of postage stamps is costly and the amount of time required to check his log and make out cards is tremendous. These fellows are really faced with a job and everything you can do to help them will be appreciated.

You may spend hours fruitlessly scanning the bands for dx. Sometimes you may work one station, while at others you'll work them one after another. As old Rufus said, "it takes a heap o' figurin' and patience to be a good hunter, but it's fun!"

... W6NKE

MULTI-ELMAC MOBILE EQUIPMENT

CHOSEN
 for use aboard the S.S. HOPE!



AF-68
 TRANS-CITER

PMR-8
 RECEIVER

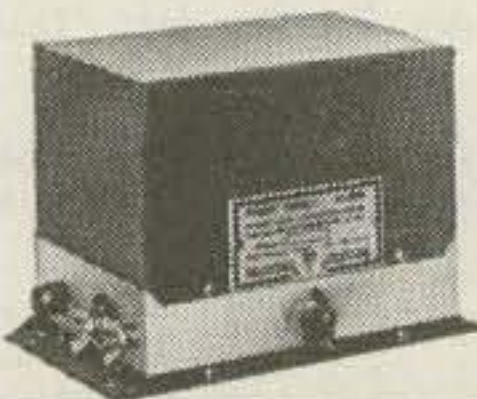

M-1070
 POWER SUPPLY

Manufactured by
MULTI-PRODUCTS COMPANY
 21470 COOLIDGE HWY., OAK PARK 37, MICH.

ANNOUNCING THE
Shorecrest 2M CONVERTER
 SUPER LOW-NOISE—CUSTOM BUILT
 USING RCA'S NEW NUVIDOR
PAUL A. REVEAL W2ADD BOX 575
 Church Street Station, New York 8, N. Y.

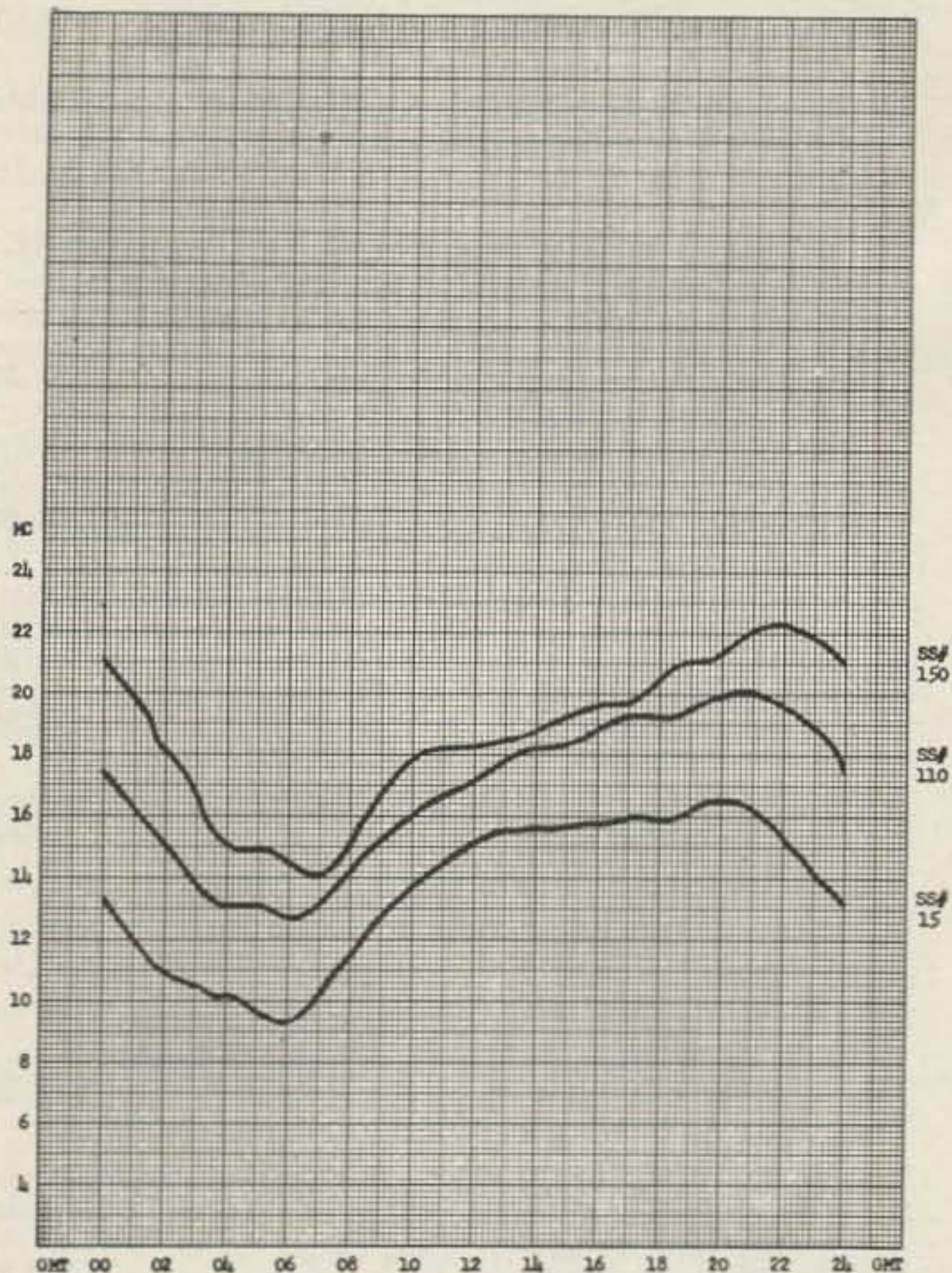

Fig. 6 explains why there are no openings this Summer to England except in the 14 mc and 7 mc bands.

I hope that the curves presented in this analysis have given you a better and clearer understanding of the variations in MUF and how the HBF for the Propagation Charts are determined. Because of all the Pros and Cons heard on the ham bands these days about 10 meters going to be dead this Winter, I have prepared a Special Propagation Chart for this coming Winter. This chart will give you an idea of what to expect over the 42 different paths, and as you can see, I expect quite a great deal of 10 meter activity.

Part III will show the influence of antenna height on Propagation for the different Ham Bands. . . . K2IGY

SAVE TIME AND MONEY

INCREASE VERSATILITY
ELIMINATE OBSOLESCENCE

BUILD YOUR EQUIPMENT
WITH VANGUARD
"PCM's" *

*printed circuit modules.

- Largest selection of circuits.
- Lowest cost.
- Every module is tested, guaranteed and complete with tubes, transistors, and crystals where required.

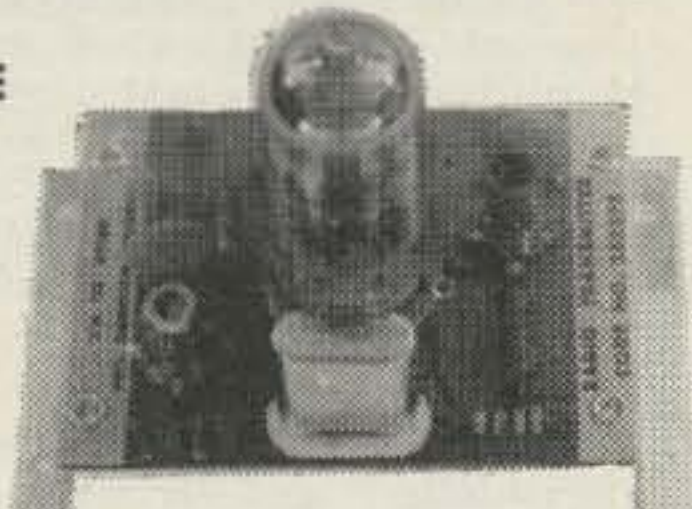

SPECIAL THIS MONTH
6 METER TRANSMITTER
\$15.99 list
NOW \$7.99

this month only

Specifications: Crystal controlled, 7 watts input to 6CX8 final, 52 ohm link output.
Power requirements: 250 V. DC @ 35 ma., 6.3 V. @ .45 a.
Send stamped self-addressed envelope for complete list of VANGUARD PCM's.

VANGUARD ELECTRONIC LABS

Dept. H-5, 190-48 — 99th Ave., Hollis 23, N. Y.



CITIZEN BAND CLASS "D" CRYSTALS

All 22 Frequencies in Stock

3rd overtone. .005% tolerance—to meet all F C C requirements. Hermetically sealed HC6/U holders. 1/2" pin spacing—.050 pins. (.093 pins available, add 15¢ per crystal).

\$2.95
EACH

The following Class "D" Citizen Band frequencies in stock (frequencies listed in megacycles): 26.965, 26.975, 26.985, 27.005, 27.015, 27.025, 27.035, 27.055, 27.065, 27.075, 27.085, 27.105, 27.115, 27.125, 27.135, 27.155, 27.165, 27.175, 27.185, 27.205, 27.215, 27.225.

Matched crystal sets for Globe, Gonset, Citi-Fone and Hallcrafters Units . . . \$5.90 per set. Specify equipment make.

RADIO CONTROL CRYSTALS IN HC6/U HOLDERS

Specify frequency, 1/2" pin spacing . . . pin diameter .05 (.093 pin diameter, add 15¢) . . . \$2.95 ea.

FUNDAMENTAL FREQ. SEALED CRYSTALS

In HC6/U holders
From 1400 KC to 4000 KC .005% Tolerance . . . \$4.95 ea.
From 4000 KC to 15,000 KC any frequency .005% Tolerance . . . \$3.50 ea.

SEALED OVERTONE CRYSTALS

Supplied in metal HC6/U holders
Pin spacing .486, diameter .050
15 to 30 MC .005 Tolerance . . . \$3.85 ea.
30 to 45 MC .005 Tolerance . . . \$4.10 ea.
45 to 60 MC .005 Tolerance . . . \$4.50 ea.



QUARTZ CRYSTALS FOR EVERY SERVICE

All crystals made from Grade "A" imported quartz—ground and etched to exact frequencies. Unconditionally guaranteed! Supplied in:

FT-243 holders Pin spacing 1/2" Pin diameter .093	MC-7 holders Pin spacing 3/4" Pin diameter .125
DC-34 holders Pin spacing 3/4" Pin diameter .156	FT-171 holders Pin spacing 3/4" Banana pins

MADE TO ORDER CRYSTALS • Specify holder wanted
1001 KC to 2600 KC:

.01% tolerance	\$2.00 ea.
.005% tolerance	\$2.75 ea.
2601 KC to 9000 KC:	
.005% tolerance	\$2.50 ea.
.005% tolerance	\$3.00 ea.

Amateur, Novice, Technician Band Crystals

.01% Tolerance . . . \$1.50 ea.—80 meters (3701-3749 KC), 40 meters (7152-7198 KC), 15 meters (7034-7082 KC), 6 meters (8335-8650 KC) within 1 KC
FT-241 Lattice Crystals in all frequencies from 370 KC to 540 KC (all except 455 KC and 500 KC)50¢ ea.
Pin spacing 1/2" Pin diameter .093
Matched pairs + 15 cycles \$2.50 per pair
200 KC Crystals, \$2.00 ea.; 455 KC Crystals, \$1.50 ea.; 500 KC Crystals, \$1.50 ea.; 100 KC Frequency Standard Crystals in HC6/U holders \$4.50 ea.; Socket for FT-243 crystal 15¢ ea.; Dual socket for FT-243 crystals, 15¢ ea.; Sockets for MC-7 and FT-171 crystals 25¢ ea.; Ceramic socket for HC6/U crystals 20¢ ea.

Write for new free catalog # 860 complete with oscillator circuits

ASK YOUR PARTS DEALER FOR TEXAS CRYSTALS
See big red display . . . if he doesn't stock them, send us his name and order direct from our Florida factory.

NOW! Engineering samples and small quantities for prototypes now made either at Chicago or Ft. Myers Plant. 24 Hour Service!
IN CHICAGO, PHONE GLadstone 3-3555

RUSH YOUR ORDER TO OUR NEW PLANT

Use coupon below for 1st Class shipment.

TEXAS CRYSTALS

Dept. G-61, 1000 CRYSTAL DRIVE, FORT MYERS, FLA.
For extra fast service, Phone WE 6-2100

ATTACH THIS COUPON TO YOUR ORDER FOR SHIPMENT VIA 1ST CLASS MAIL AT NO EXTRA COST

TERMS: All items subject to prior sale and change of price without notice. All crystal orders must be accompanied by check, cash or M.O. with PAYMENT IN FULL. No. COD's. Dept. G-61.

Radio Bookshop

YOUR RADIO knowledge is directly proportional to your reference library. You aren't supposed to know so much, just be able to look it up when the need arrives. RB has culled through thousands of radio books and selected the volumes you need most for your hamshack. Order a couple every month and get with it.

1—ELECTRONICS & RADIO ENGINEERING—Terman. One of the most complete text books ever printed. 1078 pages. Theory, but easy on the math. **\$15.50**

2 — ELECTRICAL ENGINEERS' HANDBOOK — Pender-McIlwain. This huge book should keep you busy for months just reading the interesting facts it contains. There is hardly any problem in communication or electronics that you can't find covered here. Excruciatingly thorough. 1618 pages. **\$10.00**

5—ANTENNAS—Kraus (W8JK). The most complete book on antennas in print, but largely design and theory, complete with math. **\$11.50**

6—VACUUM-TUBE CIRCUITS AND TRANSISTORS—Arguimbau. Designed for both beginners and engineers. Math kept to a minimum. Simple explanations of complex ideas. You'll know a lot more about radio after you read this book. 646 pages. **\$10.25**

8—RADIO-TELEVISION & BASIC ELECTRONICS—Oldfield. Logical presentation and descriptive illustration make this an ideal book for the beginner. Written by self-learning of electronics principles. 342 pages. **\$4.95**

10—1, LIBERTINE—Shepherd (K2ORS). Racy 35¢ book, a best-seller. Specially priced for you at . . . **50¢**

13—REFERENCE DATA FOR RADIO ENGINEERS. Tables, formulas, graphs. You will find this reference book on the desk of almost every electronic engineer in the country. Published by International Telephone and Telegraph. **\$6.00**

20—RTTY HANDBOOK—Kretzman (W2JTP). A-Z of ham Teletype. Very popular book, low supply. **\$3.00**

21—VHF HANDBOOK—Johnson (W6QKI). Types of VHF propagation, VHF circuitry, component limitations, antenna design and construction, test equipment. Very thorough book and one that should be in every VHF shack. **\$2.95**

22—BEAM ANTENNA HANDBOOK—Orr (W6SAI). Basics, theory and construction of beams, transmission lines, matching devices, and test equipment. Almost all ham stations need a beam of some sort . . . here is the only source of basic info to help you decide what beam to build or buy, how to install it, how to tune it. **\$2.70**

23—NOVICE & TECHNICIAN HANDBOOK — Stoner (W6TNS). Sugar coated theory: receivers, transmitters, power supplies, antennas; simple construction of a complete station, converting surplus equipment. How to get a ham license and build a station. **\$2.85**

24—BETTER SHORT WAVE RECEPTION—Orr (W6SAI). How to buy a receiver, how to tune it, align it; building accessories; better antennas; QSL's, maps, aurora zones, CW reception, SSB reception, etc. Handbook for short wave listeners and radio amateurs. **\$2.85**

28—TELEVISION INTERFERENCE—Rand (W1DBM). This is the authoritative book on the subject of getting TVI out of your rigs and the neighbors sets. **\$1.75**

32—RCA RADIOTRON DESIGNERS HANDBOOK—1500 pages of design notes on every possible type of circuit. Fabulous. Every design engineer needs this one. **\$7.50**

33—WAVE PROPAGATION & ANTENNAS—Welch. Highly recommended by the propagation experts as the best Book on the subject. **\$5.75**

37—101 WAYS TO USE YOUR HAM TEST EQUIPMENT—Middleton. Grid-dip meters, antenna impedance meters, oscilloscopes, bridges, simple noise generators, and reflected power meters are covered. Tells how to chase trouble out of ham gear. 168 pages. **\$2.50**

40—RADIO HANDBOOK, 15th EDITION—Orr (W6SAI). This is far and away the best amateur radio handbook ever printed. Over 800 pages. **\$8.50**

47—PRACTICAL ELECTRONICS—Hertzberg (W2DJJ). Almost solid with pictures. Touches lightly on many aspects of electronics: ham radio, TV, transistor radios, hi-fi, microwaves, trouble-shooting, Novice station, antennas, test equipment, etc. **\$2.50**

49—ELECTRONIC COMMUNICATION—Shrader. Everything you need to know about electronics, electricity, and radio to pass FCC amateur or commercial license examinations. This text has what you hoped to find in the Amateur Handbook: detailed thorough explanations of every phase of radio and electronics. 937 pages. This is one of the few really complete texts on the subject. **\$13.00**

50—MICROMINIATURIZATION—This is the standard text on the subject. Don't see how a company library can be without this one. Everything is going to have to be built smaller, you know. **\$11.00**

52—HOW TO READ SCHEMATIC DIAGRAMS—Marks. Components & diagrams; electrical, electronic, ac, dc, audio, rf, TV. Starts with individual circuits and carries through complete equipments. **\$3.50**

53—BASIC ELECTRONIC TEST PROCEDURES—Turner. This book covers just about every possible type of electronic test equipment and explains in detail how to use it for every purpose. Testing: audio equipment, receivers, transmitters, transistors, photocells, distortion, tubes, power . . . etc. **\$8.00**

54—HAM RADIO HANDBOOK—Hertzberg (W2DJJ). This is a lavishly illustrated book to interest people in the hobby of ham radio. Tells how to get your ticket, select a receiver and transmitter, learn the code. Pictures and info on just about every commercial piece of ham equipment. Better than a catalog. **\$2.50**

55—TRANSISTOR CIRCUIT HANDBOOK—Simple, easy to understand explanation of transistor circuits. Dozens of interesting applications. **\$4.95**

56—RADIOTELEPHONE LICENSE MANUAL—Smith (W6BCX). One of the editors of the old "Radio" has done a beautiful job of presenting study material in this Q & A license guide. Even if you are not going for your commercial ticket, which is accepted as proof of technical knowledge, you may want to use this manual to keep track of how far you have progressed in radio theory. **\$5.75**

57—QUAD ANTENNAS—Orr (W6SAI). Theory, design, construction and operation of cubical quads. Build-it yourself info. Feed systems, tuning. **\$2.85**

58—ANTENNAS FOR CITIZENS RADIO—Orr (W6SAI). General coverage, mobile and directional antennas for 27 mc. band. Build & tune 'em. **\$1.00**

69—S-9 SIGNALS—Orr (W6SAI). A manual of practical, detailed data covering design and construction of highly efficient, inexpensive antennas for the amateur bands t ytah ou cnbdlai u ETAO SHRD HR SLDHRDLETAO that you can build yourself. **\$1.00**

72-ABC's OF HAM RADIO—Pyle (W7OE). Designed for the Novice ham. Includes all of the information needed to qualify for the Novice License. 112 pages. **\$1.50**

74-HANDBOOK OF ELECTRONIC TABLES & FORMULAS—Formulas & laws, constants, standards, symbols and codes. Math tables, misc. data. **\$2.95**

75-BUILD-A-WARD QSL ALBUM—Mount your prize QSL's in this album. Room for 100 cards in each album plus labels for just about all possible operating awards. A fine way to show off your cards. **\$1.95**

76-MODERN OSCILLOSCOPES & THEIR USES—Ruiter. Second edition. Shows what a 'scope is, what it does and how to use it for radio, TV, transmitters, etc. 346 pages. **\$8.00**

79-TRANSISTOR PROJECTS—Skip the theory and start having fun. Radios: self powered, shirt pocket, regenerative, carrier-power, headphone. Instruments and accessories: sine-square wave generator, preamps for VTVM's, gain checker, shortwave calibrator, phase shifter, substitution box. Plus remote transistor ear, electronic compass, simple oscillator, lamp control, multi-impedance amplifier, electronic counter, portable power supply . . . etc. **\$2.90**

80-SURPLUS RADIO CONVERSION MANUAL VOLUME NO. I (second edition). This book gives circuit diagrams, photos of most equipment, and rather good and complete conversion instructions for the following: BC-221, BC-342, BC-312, BC-348, BC-412, BC-645, BC-946B, SCR-274N 453A series receivers conversion to 10 meter receivers, SCR-274N 457A series transmitters (conversion to VFO), SCR-522 (BC-624 and BC-625 conversion to 2 meters), TBY to 10 and 6 meters, PE-103A, BC-1068A/1161A receiver to 2 meters, Surplus tube index, cross index of A/N tubes vs. commercial types, TV & FM channels. **\$3.00**

81-SURPLUS RADIO CONVERSION MANUAL VOLUME NO. II. Original and conversion circuit diagrams, plus photos of most equipments and full conversion discussion of the following: BC-454/ARC-5 receivers to 10 meters, AN/APS-13 xmtr/rcvr to 420 mc, BC-457/ARC-5 xmtrs to 10 meters, Selenium rectifier power units, ARC-5 power and to include 10 meters, Coil data-simplified VHF, GO-9/TBW, BC-357, TA-12B, AN/ART-13 to ac winding charts, AVT-112A, AM-26/AIC, LM frequency meter, rotators, power chart, ARB diagram. **\$3.00**

82-SURPLUS RADIO CONVERSION MANUAL VOLUME NO. III—Original and conversion diagrams, plus some photo of these: 701A, AN/APN-1, AN/CRC-7, AN/URC-4,

CBY-29125, 50083, 50141, 52208, 52232, 52302-09, FT-ARA, BC-442, 453-455, 456-459, BC-696, 950, 1066, 1253, 241A for xtal filter, MBF (COL-43065), MD-7/ARC-5, R-9/APN-4, R23-R-28/ARC-5, RAT, RAV, RM-52 (53), Rt-19/ARC-4, SCR-274N, SCR-522, T-15/ARC-5 to T-23/ARC-5, LM, ART-13, BC-312, 342, 348, 191, 375. Schematics of APT-5, ASB-5, BC-659, 1335A, ARR-2, APA10, APT-2. **\$3.00**

83-THE SURPLUS HANDBOOK, VOLUME I—Receivers and Transmitters. This book consists entirely of circuit diagrams of surplus equipment and photos of the gear. One of the first things you really have to have to even start considering a conversion of surplus equipment is a good circuit diagram. This book has the following: APN-1, APS-13, ARB, ARC-4, ARC-5, ARC-5 VHF, ARN-5, ARR-2, ASB-7, BC-222, -312, -314, -342, -344, -348, -603, -611, -624 (SCR-522), BC-652, -654, -659, -669, -683, -728, -745, -764, -799, -794, BC-923, -1000, -1004, -1066, -1206, -1306, -1335, BC-AR-231, CRC-7, DAK-3, GF-11, Mark II, MN-26, RAK-5, RAL-5, RAX, Super Pro, TBY, TCS, Resistor Code, Capacitor Color Code, JAN/VT tube index. **\$3.00**

85-SO YOU WANT TO BE A HAM—Hertzberg (W2DJJ). Second edition. Good introduction to the hobby. Has photos and brief descriptions of almost every commercially available transmitter and receiver, plus accessories. Lavishly illustrated and readable. **\$2.95**

R245-HOW TO USE GRID-DIP OSCILLATORS—Turner (K6AI). Construction & uses, an important book. **\$2.50**

R270-REPAIRING TRANSISTOR RADIOS—Rather thorough Rider books which should remove some of the mystery and fear from servicing these little bundles of transistors. The book is expensive, but you'll save more than the price on the first set you fix so maybe it is a bargain, eh? They have all of the typical circuits to help you along. **\$3.50**

G-83-FUN WITH ELECTRICITY—This book ought to fire the imagination of the teenager. Build a galvanometer, a dc motor, an ac generator, a solenoid, a spark coil, a Tesla coil, etc. Helps teach the basics of electricity while having fun with simple projects. 128 pages. **\$2.65**

MMD-ELIMINATING MAN MADE INTERFERENCE—What makes it, how to find it, how to cure it in homes, factories, automobiles, aircraft, boats, etc. Or maybe you haven't been plagued lately. 160 pages. **\$2.95**

NHP-BUILDING UP YOUR HAM SHACK—Pyle (W7OE). A practical discussion of points to consider when you are buying ham equipment, complete with descriptions of much of the available commercial gear. It's just possible that Pyle might keep you from making a mistake which would cost a lot more than his book. **\$2.50**

QAN-SECOND CLASS RADIOTELEPHONE HANDBOOK—Noll (W3FQJ). Everything you need to know to pass the FCC exam and get started servicing two-way equipment. Much more than just a Q & A manual **\$3.95**

Handy order form for people who don't mind ripping their magazines to pieces.

1	2	5	10	13	20	21	22	23	24	28	32
33	40	47	49	50	52	54	55	56	57	58	69
70	71	72	74	75	76	79	80	81	82	83	85
R245	R270	G83	MMD	NHP	QAN						

Circle the book numbers you wish to order. Please include cash, check, money order . . . or something we can deposit in the bank.

Name: Call:

Address:

City: Zone: State:

Radio Bookshop, 1379 East 15th Street, Brooklyn 30, New York

(Power from page 51)

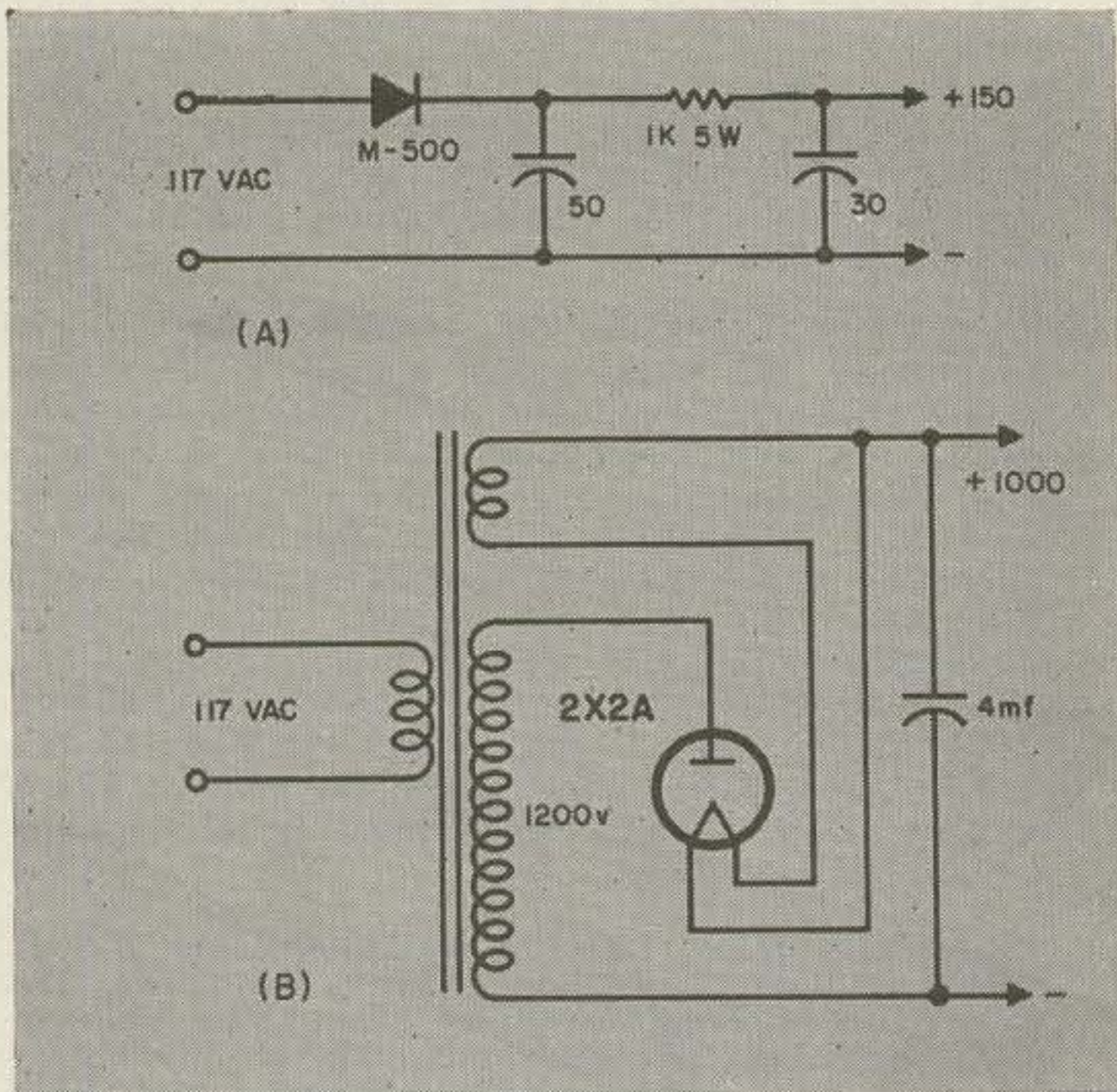

Fig. 1

valid.

More important points of difference are the magnetic fields produced in the vicinity, and safety considerations. Any power transformer will radiate strong magnetic fields, which wreak havoc in low-level audio and electron-beam-tube circuits (including SSB exciters of the 6AR5 or 7360 type as well as oscilloscopes and tuning indicators). On the other hand, all voltage multiplier circuits are tied directly into the 117-volt power lines in one way or another, thus making it possible for you to—either by carelessness or by component failure—become connected bodily to the almost-unlimited power there residing. At best, you'll get a shock. At worst, it could be fatal. Equipment, also, is subject to possible damage through interconnecting ground cables which may short out part of the power supply.

In sum, the transformerless supply offers

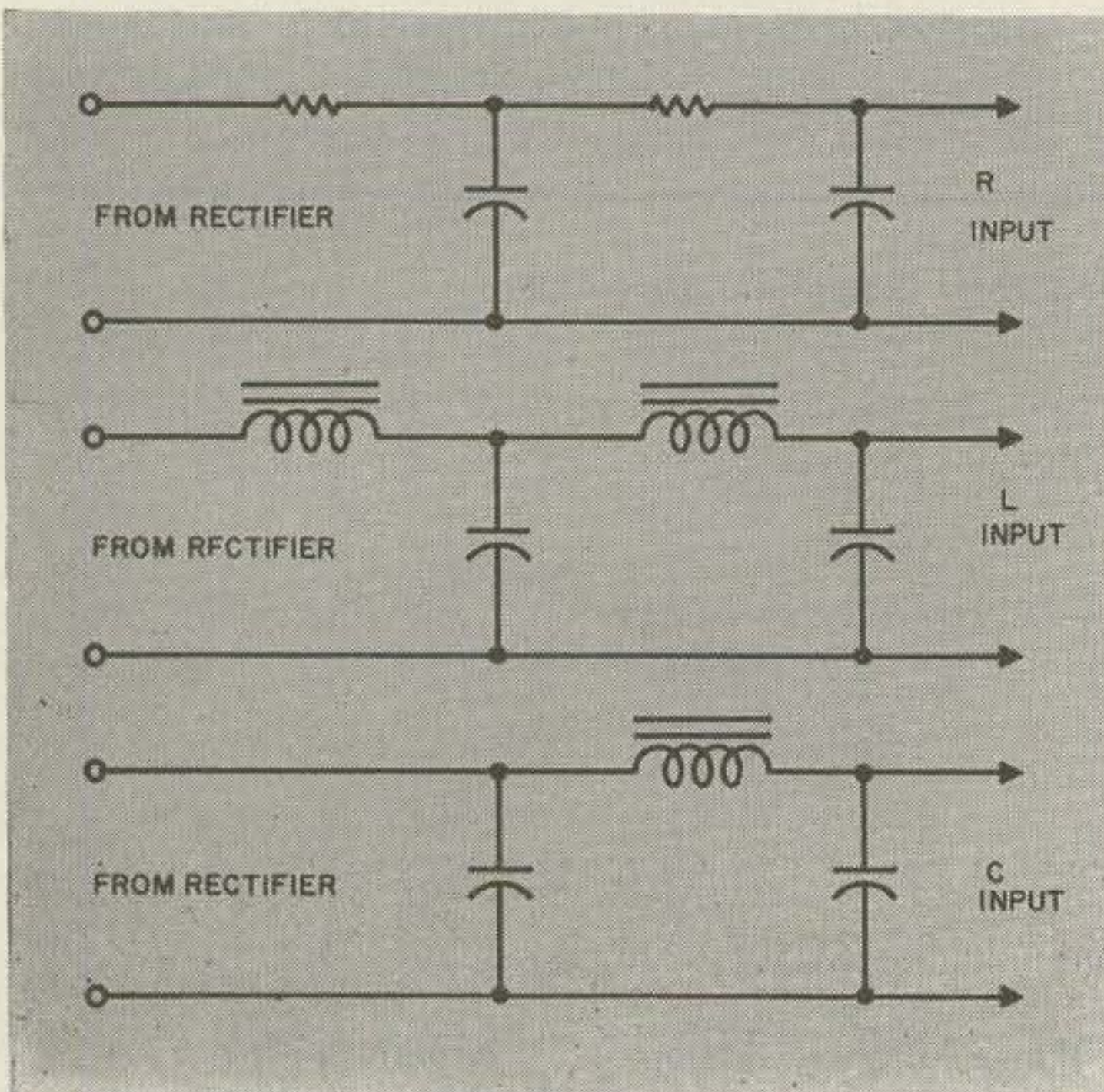

Fig. 2

freedom from troublesome magnetic fields, at the price of increased danger to both operator and equipment.

If use of a transformerless supply appears best, one way of avoiding the danger is to install an isolation transformer (cost, about \$10) in the supply line to the power supply. This can be located far enough from the equipment to avoid magnetic fields, while providing isolation from the regular 117-volt line.

Another major classification which doesn't appear to be so obvious is between power supplies using vacuum tubes as rectifiers, and those employing semiconductor diodes. While the general circuit configuration is similar, the operating conditions of the two types of units differ radically.

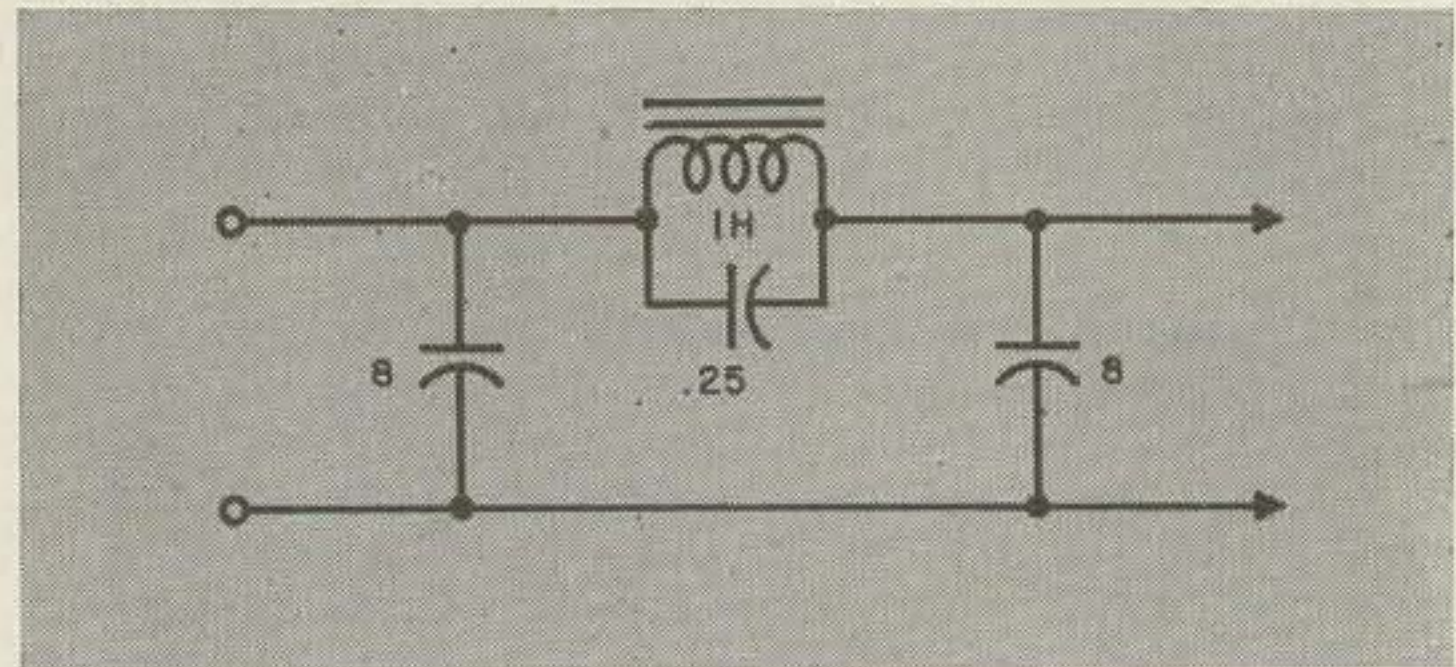

Fig. 3

A vacuum diode requires filament power, produces quantities of heat, and has a built-in voltage drop ranging from 15 to 50 volts. Semiconductor diodes require no heater power, run comparatively cool, and have an average voltage drop of about 1 to 3 volts.

However, semiconductor diodes require current-limiting resistors and an adequate heat sink, neither of which is necessary with a vacuum tube. Semiconductors, also, may subject filter capacitors to higher voltage levels, due to both the lower rectifier drop and the instant action when the supply is turned on.

Another point which must be watched with semiconductors is that of peak inverse voltage. Vacuum diodes are most tolerant of excessive reverse voltage; even the lowly 5Z3 is good for more than 1,500 volts. Semiconductors, however, will be destroyed by even slight overdoses of excess reverse voltage—and the most common types are rated for only 400 volts. This is equivalent to about 250 volts RMS, which means that units must be connected in series for medium- to high-power supplies.

Therefore, the choice between using vacuum diodes and semiconductor rectifiers must be made on the basis of a number of factors. Schematic diagrams in this article show them used interchangeably, and one may be substituted for the other in any circuit provided that the differences are allowed for.

Possibly the most common of all power-supply circuits is the half-wave rectifier, shown in Fig. 1. The usual circuit configuration is

(Turn to page 64)

THE ONLY WAY TO GO MOBILE

six meters —
ten meters

NEIL



MOBILEER VHF Phone Transmitter

- Built-in power supply; no external high voltage required, just connect to your 12 volt battery.
- Transistorized modulator and 12 volt plate tubes permit extremely low battery drain.
- All controls on front panel.
- Uses 8 mc crystals; no overtone circuits employed.
- Two built-in tuning meters eliminate fumbling for meter switch; no guessing which scale to read.
- 100% plate and screen modulation, not merely screen modulated, for constant output, maximum audio.
- Extremely compact, only 3 inches high.
- With the ease of tuning and trouble-free operation for which NEIL is famous.
- Features new, updated circuitry.

Price: MOBILEER, kit **\$134.00** MOBILEER, wired **\$159.00**
(specify band desired)

See your dealer or order from:
THE NEIL CO. 1336 Calkins Road, Pittsford, N. Y. • Baker 5-6170

For higher mobile power: Neil BETA transmitter, 60 watts, requires external power supply. Kit \$98, Wired \$125.

TEST EQUIPMENT

FREQUENCY METER, LM., Navy type of BC-221 with Orig. Calib. book & modulation	\$49.00
SCOPES, Dumont 208, 5"—\$59.00, Dumont 224, 3" ..	49.00
SCOPES, Heath 5"—\$35.00, RCA—3"	24.00
FREQ. METER, TS-127/U, 375-725 m.c.	45.00
BOLOMETER, Hewlett-Packard 415A	65.00
FREQ. METERS, BC-338A, 100-155 m.c.	45.00
WAVEMETER-OSC., OAP, 150-230 m.c.	39.00
SIG. GEN., RCA-710A, 370-445 m.c. 450-500 m.c. ..	49.00
BEAT FREQ. OSC., RCA-154, 30-15,000 cy.	29.00
RCA CHANALYST, \$45.00, Conv. to 1.6-80 m.c.	25.00
GENERAL RADIO, 224-S Wavemeter	50.00
G. R. 916-A, Radio Freq. Bridge	150.00
G. R. SIG. Gen. 700-A, B.F.O., 50 cy.-5 m.c.	175.00
G. R. 222 Precision Condenser	40.00
G. R. P522-A Sig. Gen., 250-1000 m.c.	250.00
G. R. 20 AMP. Variac, type V-20	35.00
G. R. 10 AMP. Variac, type V-10	20.00
Sig. Gen., Meas. Corp. 75, 50-400 m.c.	125.00
Sig. Gen. Triplett 3433, AM-FM, 100 k.c.-120 m.c. ..	69.00
PHILCO WIDE BAND SCOPE AMP., 20 c.y.-5 m.c., new	50.00
FREQ. METER, TS-175/U, 80-1000 m.c., orig. cal. book	125.00
V.T.V.M., Hewlett-Packard, 400A \$40.00, 400c	60.00
SIG. GEN., HICKOK 288X, 100 k.c.-110 m.c.	95.00
SIG. GEN., FERRIS 18B, 18-155 m.c.	49.00
SIG. GEN., HICKOK 610A, T.V., 0-230 m.c.	95.00

TRANSMITTERS

Viking-I	\$120.00	Viking-II	\$170.00
Viking Challenger..	95.00	Viking-6N2	85.00
Globe Chief	50.00	Viking-VFO-122	35.00
Heath DX-100	150.00	Globe Chief-90A	60.00
Eldico TR-75-TV	30.00	Millen 90801	60.00
Central Electronics Model 10A	75.00		
Johnson Viking Matchbox	45.00		

RECEIVERS

H.Q.-110, clock	\$175.00	NC-109	\$135.00
S.X.-28	95.00	S-106	45.00
H.Q.-129	125.00	B.C. 344D, 110 v. ..	50.00
NC-125	110.00	S-20R	40.00
SX-71	130.00	RAO-2	40.00
NC-120	60.00	S-94	45.00
APR-1	75.00	Gonset G33, new ..	80.00
RBM, (2-20 m.c.) with 110 v. A.C. supply	50.00		
Super Pro, BC779, with 110 v. A.C. supply	125.00		
FM receiver, 450 m.c., RCA-CRU-1A, new	40.00		

MISCELLANEOUS

TBS receiver, 60-80 m.c.-\$20.00, XMITTER	\$25.00
ARC-3, Xmitter, Receiver, Supply Cont. box	60.00
Teletype printer TT-4	85.00
DAE-1, D.F. receiver and loop	35.00
RF Wattmeter, 15/60 watt	35.00
D.F. receiver, MN-26 or BC-433	15.00
Amplifier, 25 watt, 6 tube by G.E.	20.00
TG-34A Keyer—\$25.00, B.C. 645	20.00
TBY or TBX—\$20.00, BC-375 TU	3.00
Super Pro 110 v. A.C. Supply, by Hammarlund ..	20.00

Prices are based on fair relative values, some items are new, some are used.

Enclose sufficient postage, excess will be returned. (Avoid delay)

F.O.B. Hempstead. 25% with COD orders

ALGERADIO CO.

37 GREENWICH ST., HEMPSTEAD, N. Y.
Phone: IV 9-0808

shown in Fig. 1a, and a variant for high-voltage use in Fig. 1b. Here's how it works:

A diode, by definition, can conduct only in one direction. Again by definition, this conduction occurs only when the anode is positive. With an alternating current applied to the input, the diode is almost a short circuit whenever the anode is positive and is an open circuit when the anode swings negative.

Whenever the diode conducts, a pulse of current flows through it into capacitor C. When the diode's anode is negative and the rectifier becomes an open circuit, the charge on C remains stationary. These actions occur on alternate half-cycles of the input current; the diode's one-way-gate action turns the ac input into pulsating direct current.

It's clear that only half the input wave is used; the other half is blocked and never appears in the output. The pulses of direct current occur at the same frequency as the alternations of input current polarity. Use of only half the wave means that efficiency can never exceed 50 percent, and the low ripple frequency present in the output means that adequate filtering (which we'll go into later) is difficult to achieve. For these reasons, the half-wave rectifier is limited in application. No other power supply circuit is so economical with

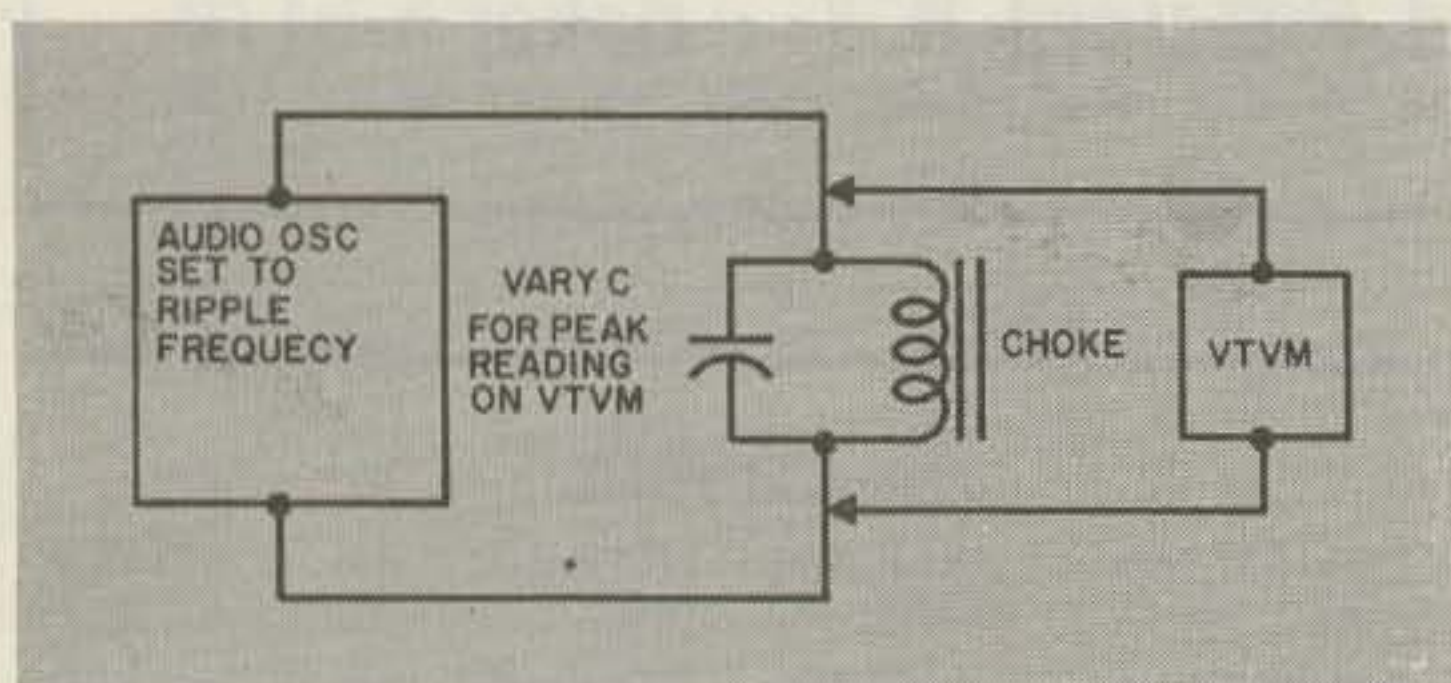

Fig. 4

parts, but virtually every other circuit gives better efficiency and output.

Before going on to other circuits, though, let's take a look at the filter since it's as important to a power supply as is the rectifier circuit. A common filter circuit is shown in Fig. 1. However, comparison between the three major types can be seen more easily in Fig. 2.

The basic purpose of any filter circuit is to remove the ac component (usually called ripple) from the rectifier output. Without a filter, the output consists of pulsating direct current. The filter smooths out the pulses into something approximating pure dc.

It's important at this point to emphasize that *no* filter can ever turn rectified ac into completely pure dc. Even the most elaborate (and costly) low-impedance highly-regulated power supplies still have a trace of residual ripple in their output. However, it is easily possible to reduce the ripple so close to zero that for all practical purposes you can't tell the difference.

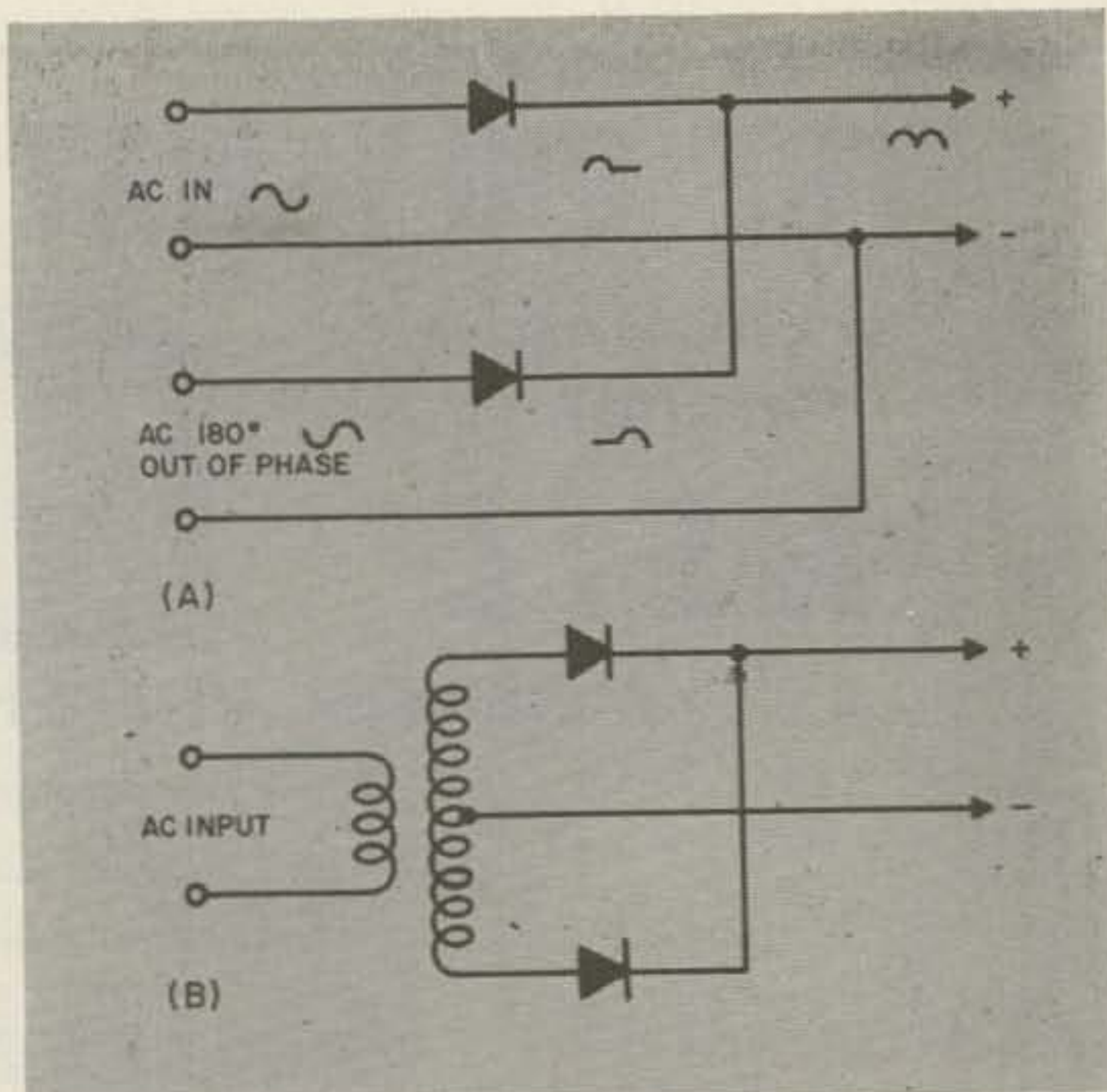

Fig. 5a and b

How much ripple to tolerate is determined primarily by the purpose for which the supply will be used. Most published circuits and charts are based on a 1-to-5 percent ripple figure. This is far more filtering than necessary in some applications and not nearly enough in others. For example, the power supply for the first audio stage of a high-gain modulator (such as might be used with a low-output dynamic mike) should probably contain less than 10 millivolts of ripple. If the supply voltage is 100, this works out to 0.01 percent residual ripple.

On the other hand, the supply for a class B modulator operating at the 500-watt level would be perfectly acceptable with as much as 25 to 30 volts ripple, at a level of 1000 volts and provided that the modulator were push-pull.

In design stages, the best bet is to work for a nominal 1-percent ripple figure. This can be modified upwards for high-voltage supplies if component cost starts to skyrocket. Then, when the supply is finished, if ripple proves objectionable another filtering stage can be added. Like amplification, the effect is multiplied rather than added, so one extra stage will usually do the trick.

Now to the three types of filter circuits. They're usually classified according to the input elements as capacitor-, resistor-, or choke-input filters. From the circuit-theory viewpoint, they divide into pi- and T-section networks (by lumping the choke- and resistor-input filters together).

While they accomplish the same end, they go about it in different ways and each has its own application. The capacitor-input filter uses the comparatively low ac impedance of the input capacitor to do the bulk of its filtering. The resistor- and choke-input types use the high impedance of the input element to block most of the ripple from the output.

The capacitor-input unit, therefore, presents a heavier load on the rectifier circuit than either of the other types. This means that (theoretically at least) either of the other types can produce more usable output current from a given rectifier than can the capacitor-input. In practice, the resistor-input filter is limited to low-current applications since its input element offers just as much resistance to dc as to ac.

Tending to balance the ledger to some degree is the fact that, *under light loads*, the input capacitor of the capacitor-input filter tends to charge up to the peak ac supply voltage and to remain charged to almost this level during operation. The choke-input unit, on the other hand, has a tendency to give output at approximately the RMS input level because its impedance is highest when voltage applied to it is high.

Therefore, for a given rectifier circuit and under light loads, the capacitor-input filter provides a higher output voltage than does the choke-input unit. This is the main reason for its popularity in commercial circuitry. However, under heavier loads the advantage disappears, because the capacitor is discharged partially during each "off" cycle of rectifier operation.

The effect shows up as poor regulation under load for the capacitor-input unit as compared to the choke-input type, which together with the current-capability characteristics of the choke-input filter swing the balance far in favor of choke input for heavy, varying loads such as are found in transmitter operation. Receivers, audio equipment, and test gear, on the other hand, usually benefit from the higher voltage capability of the capacitor-input filter and present a load constant enough that the regulation isn't harmful.

No matter which type of filter is used, one section of filtering usually isn't enough. For most efficient results, the rule in adding extra sections is to use the *other* type of filter for the second section. That is, if the first section is choke-input, the second would be capacitor-input. The capacitors of the two sections are physically merged into a single unit, presenting the familiar ladder-circuit form.

Since most filter circuits involve both capacitance and inductance, they have some reson-

(Turn to page 66)

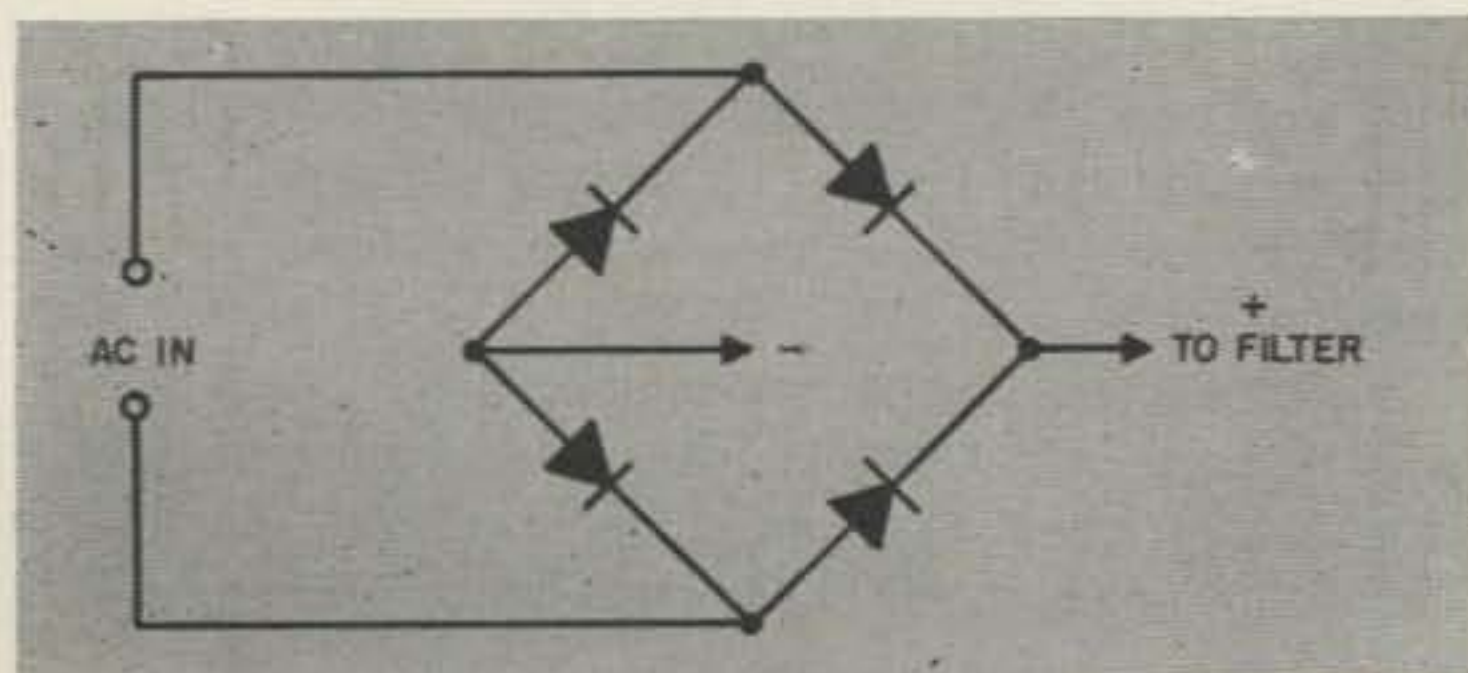

Fig. 6

KEEP CANDEE HANDEE!

COMMAND GEAR

Famous Q-5'er. 190-550 kc. The receiver you've been looking for at only \$9.95
 BC-454/R-26: 3-6 Mc. \$9.95
 BC-455/R-27: 6-9.1 Mc. \$9.95
 MD-7 MODULATOR: Special 3.95

A TRIO OF HEADSET BARGAINS!

HS-23: Hi impedance. Leather covered headband. Brand new. Great buy. Only \$4.95
 HS-33: Low impedance. Leather covered headband. Brand new. A. J. J. Candee Special 5.95
 Hi Fi Headset: 15,000 cycles! Brand new with chamois cushions. It's terrific! Only 8.95
 CD-307A Headset Extension Cord: Brand new. Approximately 5 ft. length. Only49

APN-1 FM TRANSCEIVER

420-460 Mc. Compl. with tubes. Exc. Ea. \$2.95
 Approx. shp. wt. per unit 25 lbs. TWO for 5.00

YOU GOT IT! WE WANT IT! LET'S DEAL!
 We're paying top \$\$\$ for GRC-9; PRC-6, -8, -9, -10; GN-58A; All electronic test equip.

R-4A/ARR-2 RECEIVER

234-258 Mc. 11 tubes. UHF, tunable receiver. See Aug./59 C.Q. Magazine for conversion. Excellent cond. TWO for \$5.00. Each \$2.95

APX-6 TRANSPONDER

A midget warehouse of parts! Blowers, three Veeder-Root counters, I. F. strips, cavity, over 30 tubes, etc. Includes 3E29 tube. Good cond. A STEAL AT ONLY \$9.95
 APX-6 Manual \$1.50

T-67/ARC-3 TRANSMITTER—

100 to 156 MC. Used: \$14.95

R-77/ARC-3 RECEIVER—

100 to 156 MC. Used: \$14.95

ADF AN/ARN-7

Receiver R5/ARN-7 \$29.95
 Loop LP21LM 7.95
 Inverter MG-149F 9.95
 Control Box C-4/ARN-7 5.00
 Mount FT-213 3.00

T-18/ARC-5 XMTR. 2.1-3 MC excnt cond. \$4.95

T-19/ARC-5 XMTR. 3-4 MC xlnt cond. 7.95

T-20/ARC-5 XMTR 4-5.3 MC xlnt cond. 4.95

T-21/ARC-5 XMTR 5.3-7 MC xlnt cond. 4.95

APN-4 LORAN EQUIPMENT

Marine or airborne. Long range navigational gear to determine exact position of ship or plane up to 1200 miles from base. Complete with tubes, crystals. Ex. Only \$19.95

ART-13 COLLINS

Transmitter, removed from aircraft, 10-channel auto-tune or manual. 2-18.1 Mc. for Ham Rig with 813 final. Output 60-100 W. CW or modulated. Crystal-calibrated for VFO. Exl. Cond. Only \$33.33

RT91/ARC-2 TRANSCEIVER

Airborne; AM, CW, MCW, Output 40 W. Input 500MW Freq. Range 2000 to 9050 KC in eight channels; Input 26.5 volt DC, excl. cond. ship. wt. 100 lbs., w/control box \$39.95

All items FOB Burbank, Calif., subject to prior sale. In Calif. add 4%. Min. order \$3.95.

J. J. CANDEE CO.

Dept. MS

509 No. Victory Blvd., Burbank, Calif.
 Phone: Victoria 9-2411

ant frequency. If this frequency is near the ripple frequency, anything can happen. The best rule is to make certain that the resonant frequency is at least an octave lower than the ripple to avoid trouble.

However, resonance in filters can occasionally be used to advantage. One example is the old BN radar, used as an IFF unit by the Navy throughout World War II. Its power supply used a resonant choke, tuned by a 0.25 mfd capacitor, to block 120-cycle ripple current. This enabled use of a smaller choke than would otherwise have been necessary. The circuit is shown in Fig. 3. However, capacitance values must be determined by experiment for the individual choke. The setup for picking the proper capacitance is shown in Fig. 4.

After this swing through filter circuitry, let's go back to the rectifier and see what we can do to increase efficiency. As we saw, the half-wave circuit effectively threw away half the input power. Now if there were just a way of using that other half-cycle, we could double power output.

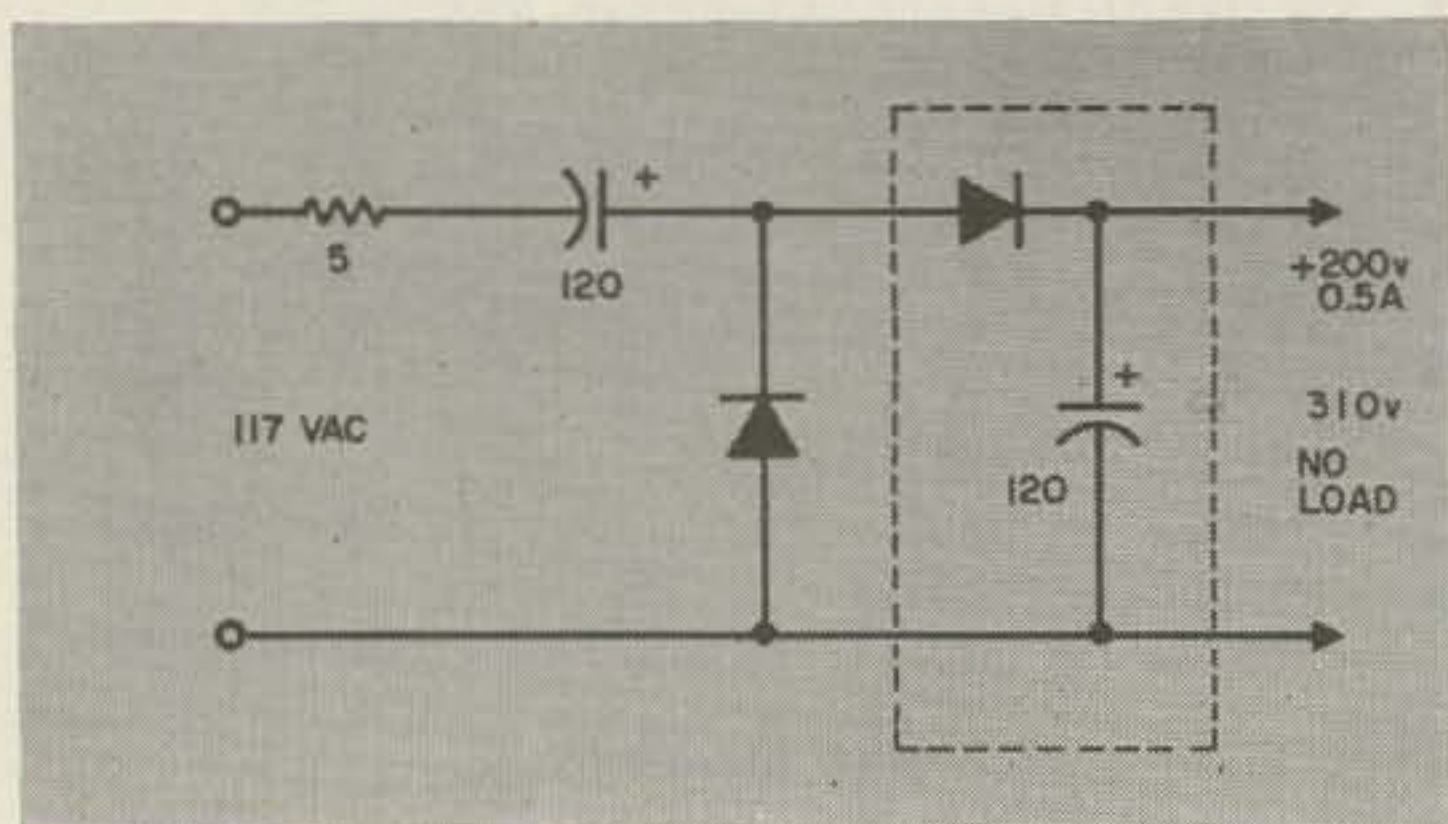

Fig. 7

By reversing phase of the input power and putting it through another half-wave circuit connected in parallel with the first, we can do just that. The developmental circuit is shown in Fig. 5a, and the same circuit in its more-familiar form appears in Fig. 5b. As can be seen from Fig. 5A, the circuit operates in a manner almost identical to the half-wave unit but twice as often.

The full-wave rectifier picks up another advantage besides higher power; since it operates twice as often as a half-wave circuit, the output pulses occur twice as rapidly, which means that ripple frequency is twice as high as the input. This allows us to use smaller filter components to accomplish the same purity of output.

Because of these advantages, the full-wave rectifier circuit is the one most widely used in all types of electronic equipment with the exception of entertainment radio and TV sets, where cost considerations make the transformerless half-wave circuit attractive for ac-dc radios and the necessity for eliminating magnetic fields make other transformerless circuits popular for TV.

However, the familiar circuit of Fig. 5b is

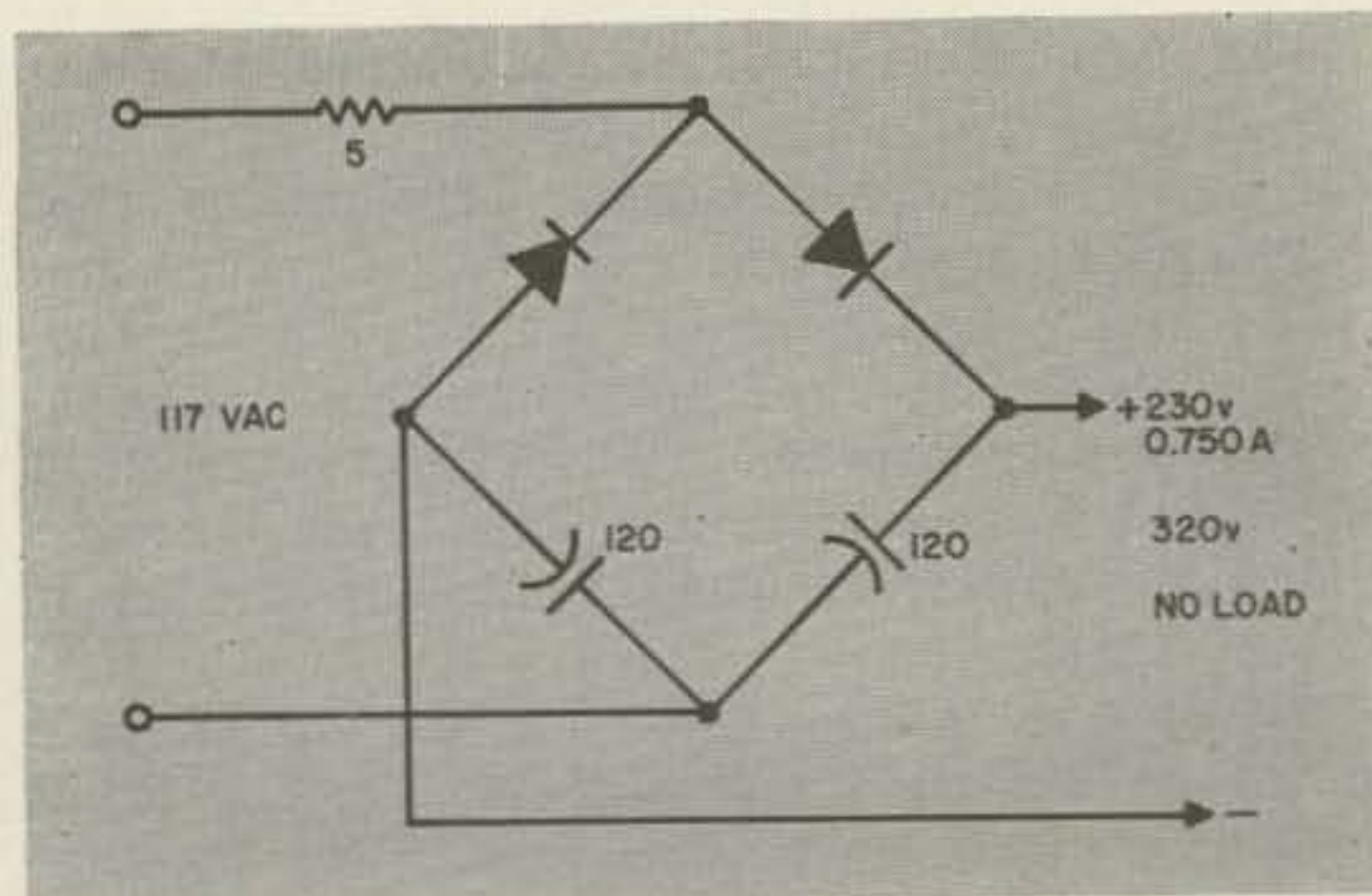

Fig. 8

not the only full-wave rectifier. Another one, long popular for low-voltage applications and now gaining popularity for other uses since the advent of semiconductor rectifiers, is the bridge shown in Fig. 6.

Unlike the preceding full-wave circuit, the bridge rectifier bears little resemblance to a half-wave circuit. It utilizes the gating property of its rectifier diodes to steer the ac input in the proper direction, depending on polarity.

Obvious disadvantages are the need for four diodes instead of two, and slightly greater circuit complexity. However, the transformer used can be smaller by half than is necessary with the ordinary full-wave—and the bridge can be used without transformers where the ordinary full-wave cannot. However, in this case B— will not be connected to either side of the line directly but will be at a potential halfway between B+ and the line. This is no advantage—it adds to the dangers rather than detracting from them.

The extra diodes aren't so much of a disadvantage as they might appear, since each can be smaller than would be used otherwise (they're in series at all times for the rectified current).

Before going further, let's compare the input voltage and the dc no-load output voltage for each of the three circuits we've examined so far. With an arbitrary input, the half-wave rectifier will give us approximately the peak-ac value of the input as its dc output. The center-tap full-wave will give us something less than half that output, although it provides twice the current. The full-wave bridge gives approximately the same voltage and current output as the half-wave circuit, but wastes less input power doing so.

What happens if we need a higher dc output voltage? Of course, we can always use a different transformer if we've chosen to build transformer-type power supplies, but if not, then what?

Fortunately, there are circuits not too distantly related to the bridge which can multiply input voltage. One of the earliest of these (which made the table model radio possible way back when) is the half-wave doubler.

The circuit is shown in Fig. 7. Note that

the lower part of the circuit, enclosed in dotted lines, is similar to the half-wave circuit already discussed. The remaining components, also, form another half-wave circuit. Output voltage of the two separate circuits is taken in series, giving twice the peak-ac input value on light loads. This means that such a doubler operating from standard house lines will give about 300 vdc at no load.

The major disadvantage of this circuit is that output falls off rapidly with load. On top of that, it has all the other disadvantages of half-wave circuitry.

Another doubler circuit, once popular in TV sets but seldom used now, is the full-wave doubler shown in Fig. 8. Note its resemblance to the full-wave bridge rectifier.

In operation, each capacitor is charged by one diode, on alternate half-cycles of input. When one diode is "off" the other is "on," using both halves of the input cycle. The two capacitors, each charging to peak-ac input voltage value, are in series, making the no-load output equal to twice the peak input value.

Like the half-wave doubler, output falls off with heavy loads, but the full-wave circuit will take more load than the half-wave for the same voltage output because of its higher efficiency. Using semiconductor diodes and extremely large capacitors (300 mfd each) the fullwave circuit will deliver 260 volts at 500 ma, where at the same load the halfwave output is only 225 volts. Halfwave output voltage drops to 210 at 1-amp output, while full-wave is 245 at the same current.

The reason for the full-wave doubler's fall from grace in commercial TV design had nothing to do with any basic circuit flaw; it just put too much strain on heater-cathode

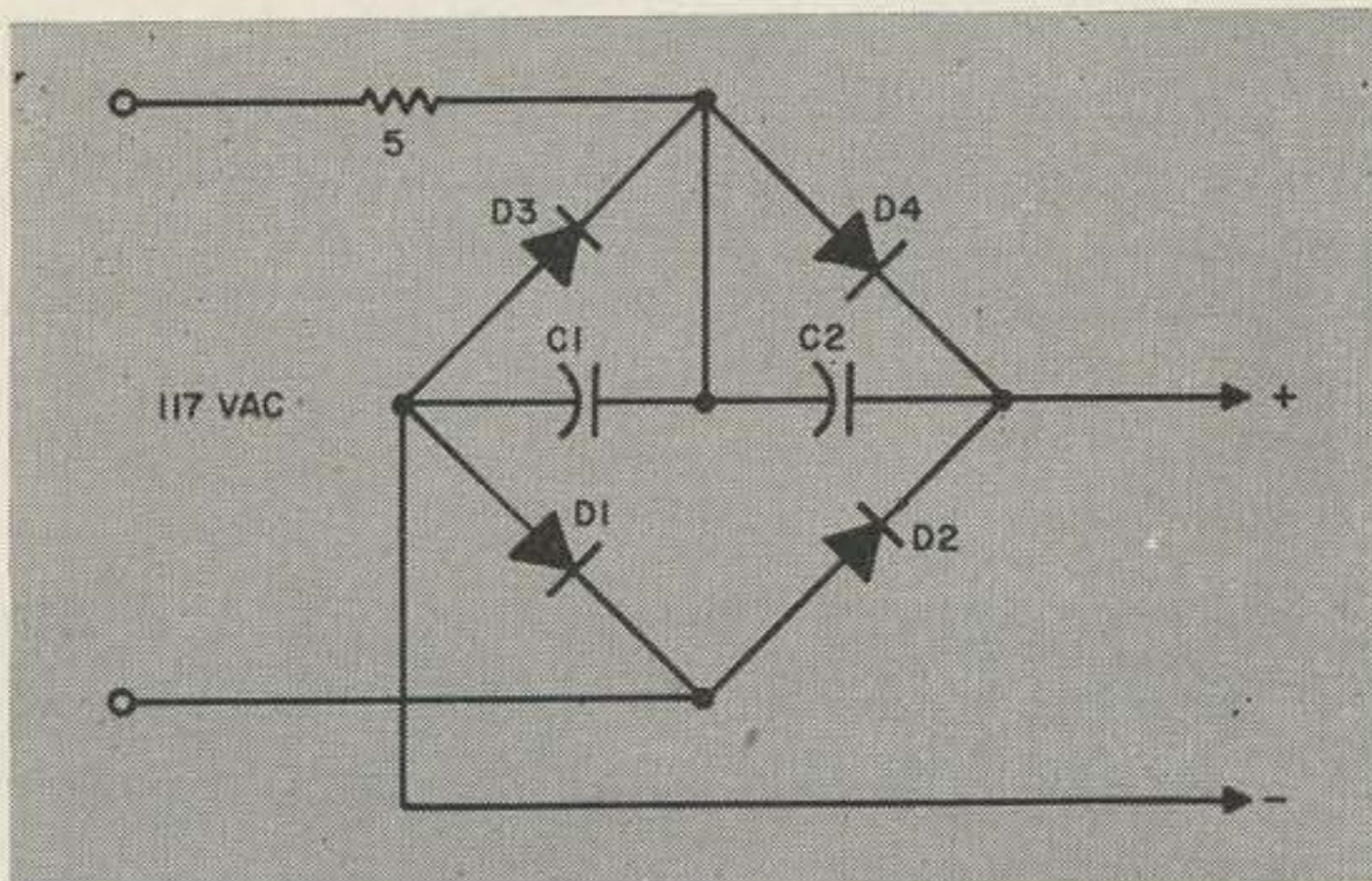
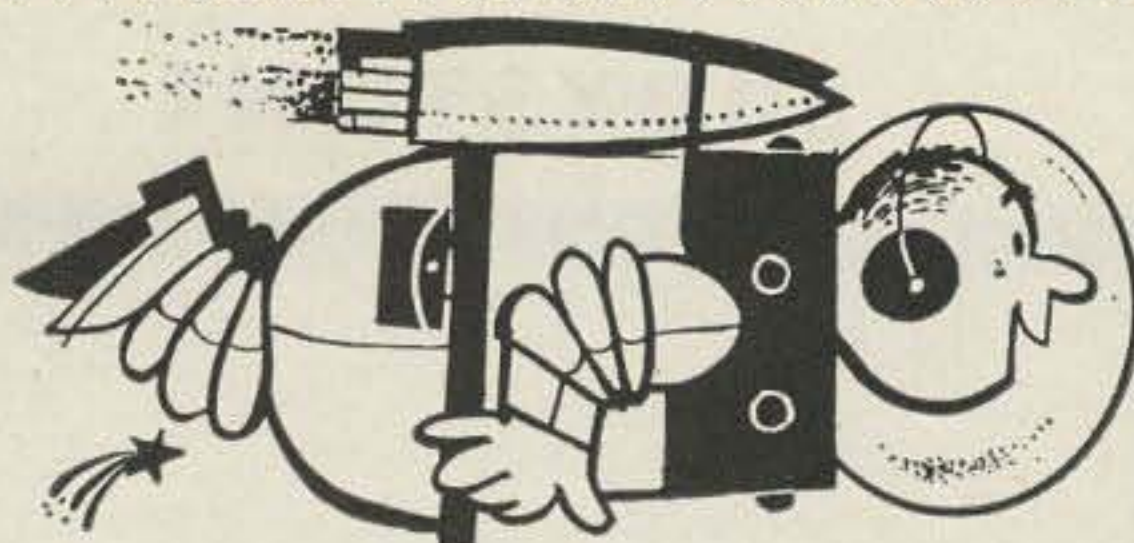

Fig. 9

insulation when tube filaments were arranged in a series string. If filaments are supplied from a separate transformer you should have no trouble with the circuit.

If still higher output voltage is needed, either the half- or full-wave doublers can be extended to triple the input voltage. The full-wave tripler circuit is shown in Fig. 9, and

(Turn to page 68)



BARRY'S VALUES ARE "OUT OF THIS WORLD"
Send for your 1961 "GREENSHEET" CATALOG today!
Hundreds of specials on equipment, components and tubes.

Here are a few samples:
C.D. Ham M Rotator. Brand new boxed. Complete. \$110.00
Mosley TA-36 10, 15, and 20 meter beam. \$125.00

50' 8 Conductor Color-Coded Cable: Each lead is color coded and tagged and numbered. There are 8 spade lugs on each end. Line is excellent and insulated with rubber covering. Each lead is individually covered with rubber also, for added protection. 50' Roll \$2.95

SPECIALS

• NC-270 (NTS-3 Matching Speaker included FREE.) Price: write. No charge for shipping in Continental USA.

• NC-400. Price: write. No charge for shipping in Continental USA.

• RCA PRECISION KC 500 CRYSTAL OSCILLATOR.

Accuracy plus or minus 0.0012%. Contains precision 500 KC crystal, BMS Labs Crystal oven, 5840 sub-miniature tube. Hermetically sealed, Nickel plated rectangular case. Mounts in standard 7 pin miniature socket. Requires 6.3 VAC or DC, 75 to 100 V.D.C. With schematic, RCA Type A8838300-1. Size 4 1/2" H x 1-7/16" W x 1 1/8" D. Wt.: 1 lb. Cat. #4-500 CRV. (Orig. Govt. Cost: \$172.00.) VERY SPECIAL ONLY \$3.75
Pwr Xfmr: Pri: 115 VAC 60 CPS. Sec: 1260 VCT @ 425 Ma; also 30 V. @ 1.05 Amps. Filament (1) 6.4 VAC @ 7.5 Amps. (2) 6.3 VAC @ 3.7 Amps. (3) 5 VAC @ 4 Amps. Hermetically sealed. Order Hazeltine #TR-1285. \$12.50

RCA Mica Capacitor: 4,000 Mmfd. 3000 V. Peak. \$1.95.

RCA PLATE Xfmr: 1290 V.C.T. @ 360 Ma. Pri: 115 V. w/taps. 60 CPS. Herm. sld. \$4.95.

Johnson Variable Capacitor: Dual 215/215 Mmfd. .125 spacing (4500 V.). \$7.75.

RCA Plate Xfmr: 905 VCT @ 360 Ma. Pri: 115 V. w/taps @ 60 CPS. Herm. sld. \$3.95.

Merit Choke: 10 Hy 250 Ma. #C-3182. \$2.95.

Superior Powerstat Variable Auto-Xfmr Type 10: Input: 120 V. 60 CPS, 1 Phase Output: 0-120/132 V. @ 1.25 Amps. Removed from new equipm't. With knob & dial. \$5.95.

Xmtg. Variable Capacitor: Approx. 20 to 750 Mmfd. @ 4,000 VDC. In oil-filled glass enclosure. 6 1/4" L x 3 1/8" H x 3 1/8" W overall. \$11.95.

Johnson Socket #122-101: For VHF use w/tubes such as the 826, 832, 4D32, 4D22, PL6549 & PL6569, etc. Special terminals permit direct mtg of grid coils. This 7 pin wafer socket only \$1.00. (Brand New Surplus)

Xmtg Variable Capacitor: 72 to 1,008 Mmfd. @ 3500 V. Ceramic ins. \$8.50.

Variable Capacitor: 18 to 400 Mmf. 1000 V. Ceramic ins. \$2.50.

Min. 125 Watt Modulation Xfmr: Pri: 10K P to P. Sec: 4550 Ohms. (Screen winding 3300 Ohms) Insulated for 5KV Peak. Orig. designed for PP 4-65A's. Approx. 3" x 3" x 3". 3 lbs. \$6.95.

Special Eimac JAN 4-65A's @ \$10.00 each.

Johnson #213 Sockets for 304TL & 304TH. Brand-new (surplus). \$1.15 each. (4 for \$4.)

Cathode Ray Tube Shield (for tube type 2BP1). \$2.95.

Cornell-Dubilier 4 Mfd. @ 4000 VDC Oil Capacitor: \$9.95 each (3 for \$27.00).

UTC Type S-32 Swinging Choke: 5/25 Hy Hy/225 Ma/120 Ohms. \$4.90.

Plate Xfmr: Pri: 115 VAC @ 60 CPS w/taps. Sec: 3200 VCT @ approx. 300 Ma. \$10.50.

Filter Choke: 8 Hy. @ 200 Ma. (90 Ohms D.C. Resistance). Hermetically sealed. \$1.75.

RCA CRV-59AAC TV Camera/Xmtr with 1846 Iconoscope—\$95.00

Hipersil Type Compact construction. Approx. 3" x 3" x 3". Ideal for pair of 4-65A's —\$6.95.

Add 50¢ Service Charge for orders under \$5.00. Prices are F.O.B. NYC.

Come in and browse. We are open Mon. to Fri. 9 to 6. Sat. 10 to 2 P.M.

Jennings vacuum variable capacitor 10 to 300 mmfd at 10 KV in original Jennings carton. Unused surplus \$49.00. Regular \$149.00. SPECIAL!

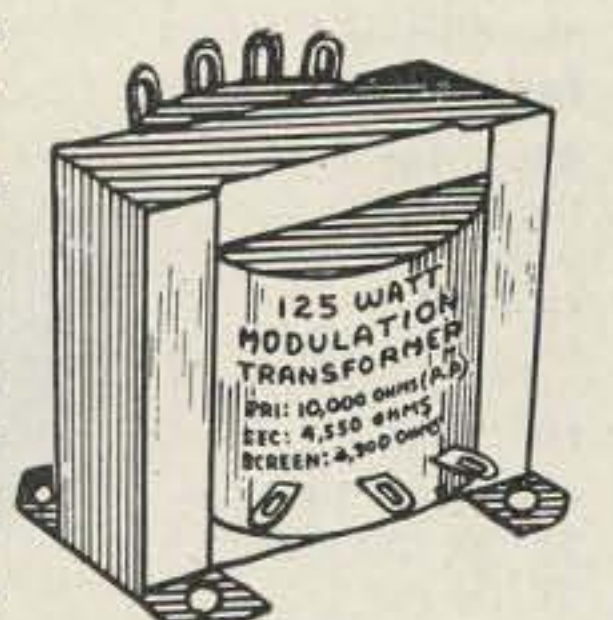

BARRY ELECTRONICS

512 BROADWAY,
NEW YORK 12, N.Y.

WALKER 5-7000

EDDYSTONE

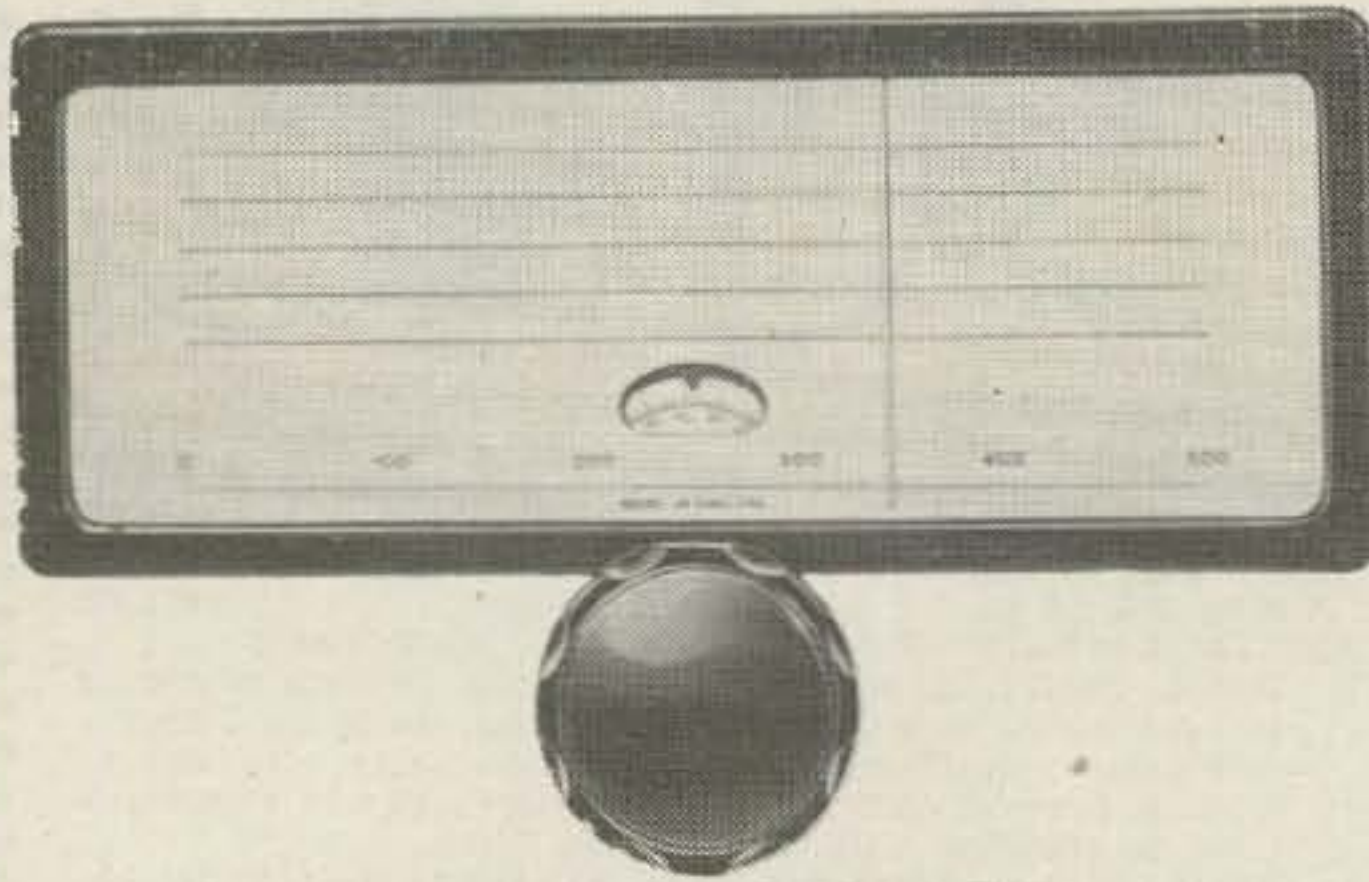

GEARED SLOW MOTION DRIVE
For Amateur Radio & Communications
RECEIVERS & TRANSMITTERS

A high grade assembly, flywheel loaded, manufactured to fine tolerances, provides a smooth positive drive with a reduction ratio of 110:1. The vernier with its 100 divisions rotates 5 times for one pointer traverse, giving 500 divisions with positive reset readings. A cam adjustment on the vernier assures correct zero setting. A spring loaded jockey arm maintains tension of the pointer drive. Overall dimensions 9³/₁₆" x 5³/₄".

Manufactured by
Stratton & Co., Ltd. (Eddystone)
Birmingham, England

PRICE \$16.50 NET
Postpaid

Distributed by
BRITISH RADIO ELECTRONICS, LTD.
1833 Jefferson Place, N.W.
WASHINGTON 6, D. C.

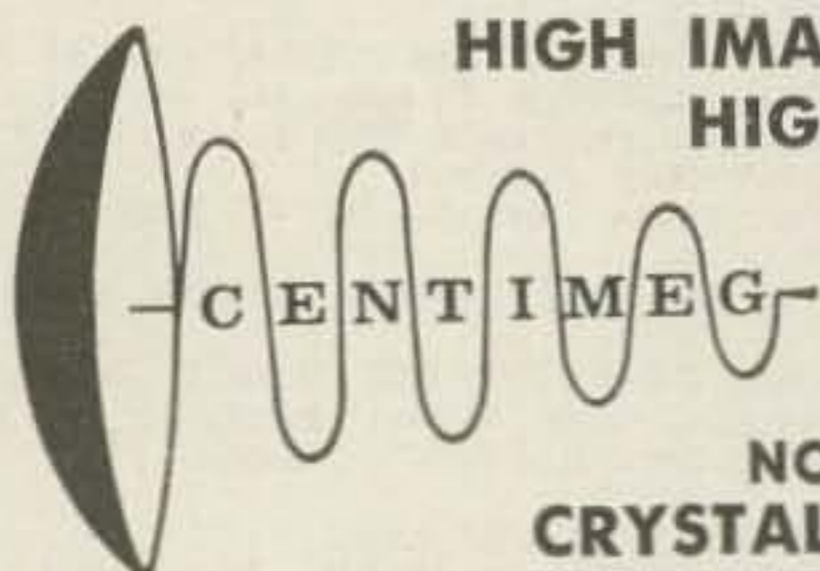

HIGH IMAGE REJECTION
HIGH SENSITIVITY
LOW NOISE

CENTIMEG 432 mc

NOISE FIGURE 6 DB
CRYSTAL CONTROLLED
CONVERTER

\$69.50

Flat Bandpass
Silver plated
cavities.
No birdies.
Beautiful Styling

Also for
the same
price.
220 mc
NF: 4/6 DB
or 144 mc
NF: 4DB

Outputs: 14/18,
26/30, 30.5/34.5,
50/54 mc
on any model.
3 lbs.

FOB factory. Calif.
add 4% sales tax.

Other Centimeg Products:
PS-C pwr. supply for converters.....\$24.95
432 mc Tripler-Amp. Exciter: your 2M rig,
with 2C39\$84.50
less tube \$69.50

432 mc xtal cont. xmtr. 10 watts out (2C39)..\$184.50
Send for free brochures on our complete line
of equipment.

CENTIMEG ELECTRONICS

312 E. Imperial Highway El Segundo, California

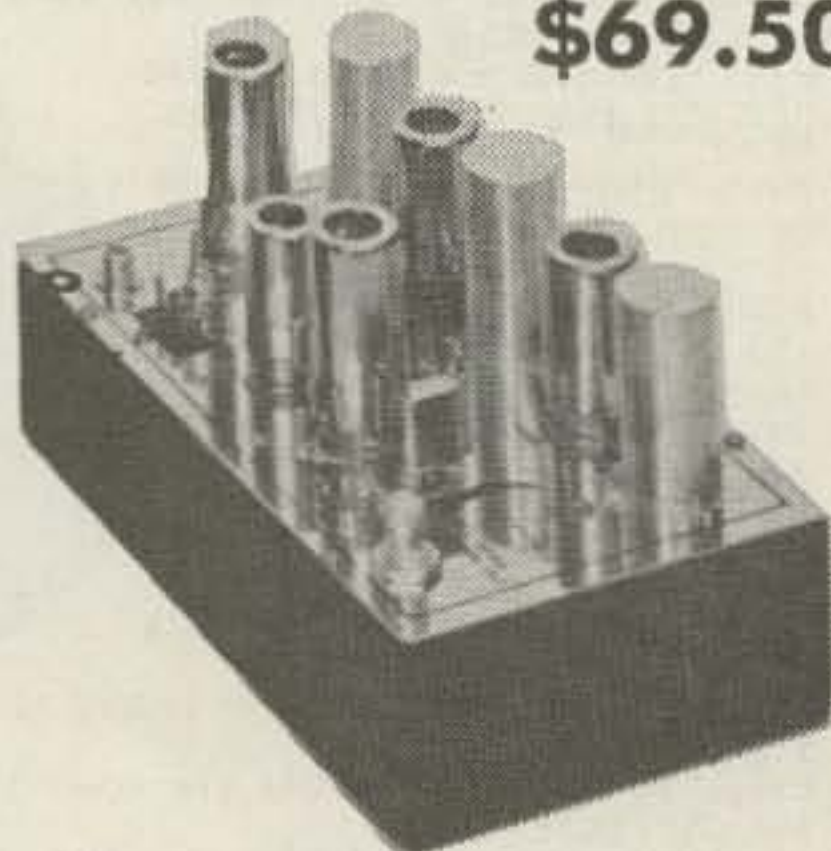

(From page 67)

the half-wave tripler in Fig. 10.

The full-wave tripler is seldom used—possibly because it is so little known. Its advantages over the more-common half-wave tripler are those of any full-wave circuit over an equivalent half-wave arrangement, yet most reference books fail to mention its existence and no commercial design using the circuit could be located.

In operation, diodes D1 and D2 together with the two capacitors form a full-wave doubler. In addition, all four diodes act as a fullwave bridge, independently charging first one capacitor and then the other to peak line voltage. Since capacitor charge is additive, the result is tripled voltage at the output.

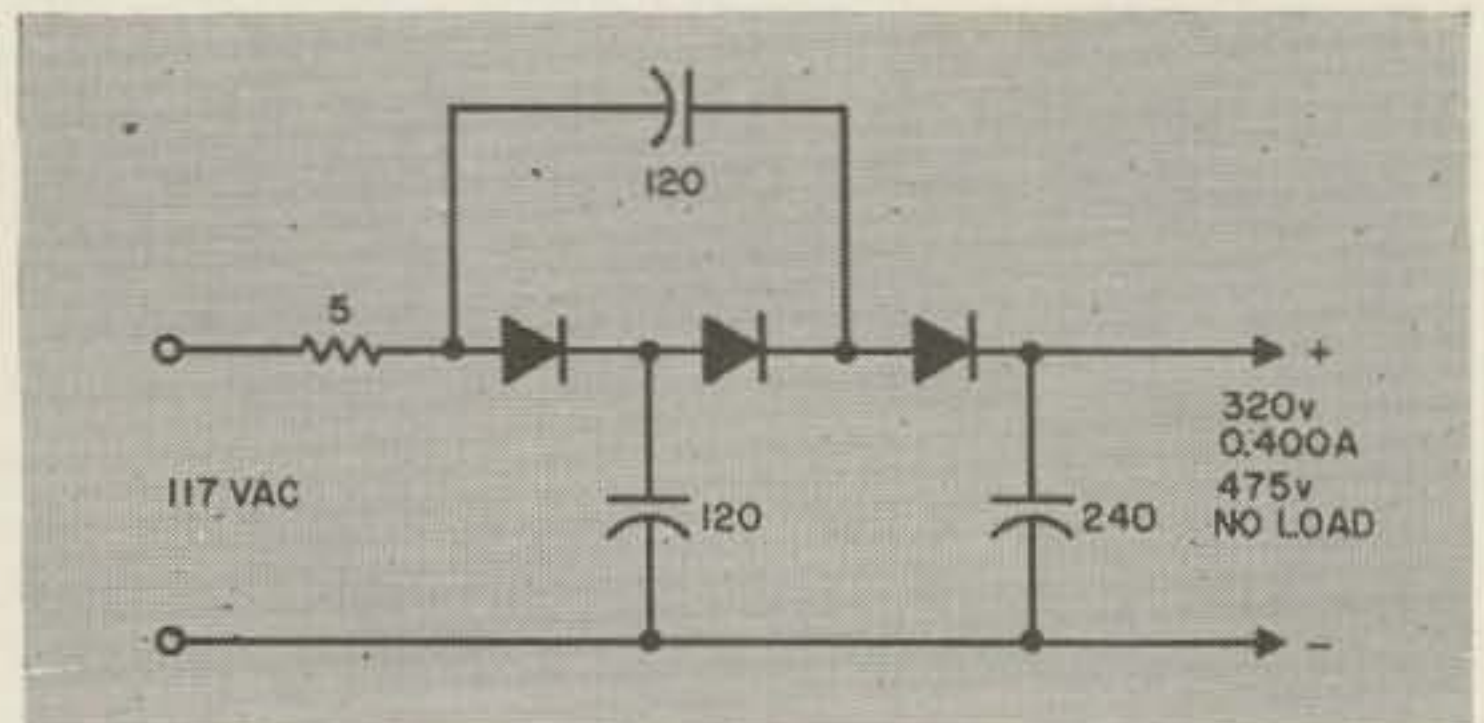

Fig. 10

The half-wave tripler of Fig. 10 is similar in action to the doubler of Fig. 7, with an additional diode and capacitor added in series. In fact, this circuit can be extended as far as you like, to give "n-fold" multiplication of input voltage, but regulation drops rapidly as the voltage output climbs. One version, using 8 diode-capacitor pairs to give a nominal 900-volt output suitable for oscilloscope use, is shown in Fig. 11.

So far, we've looked at the basic power supply circuits, filters, and voltage multipliers. We're a long way from being finished. Coming up in Part II, next month, are voltage regulators, both active and passive; a tricky filter circuit which eliminates chokes; some ultra-miniature power supplies, and several surprises.

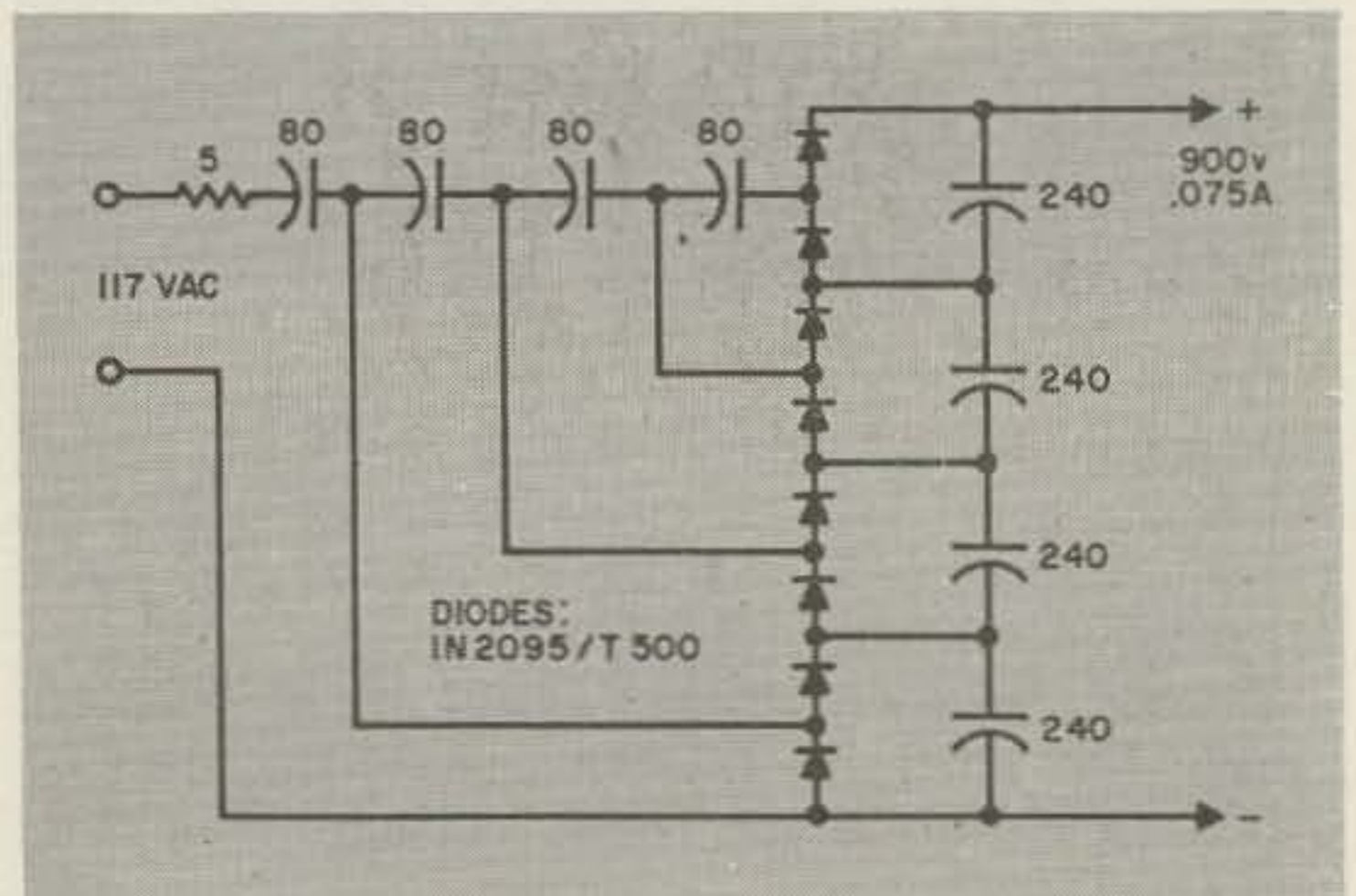
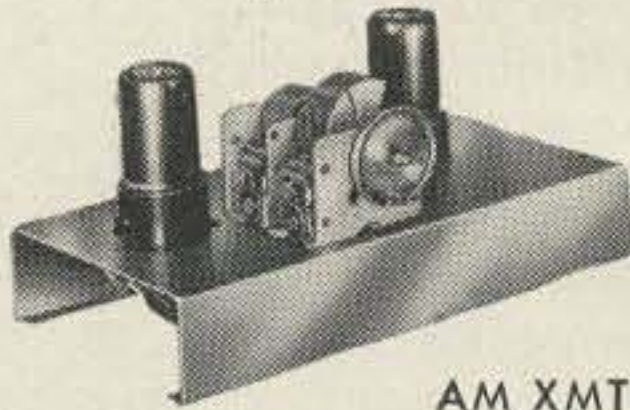

Fig. 11

Get Smart!

Build these and 13 other pieces of equipment which will enable you to learn the in's and out's of Radio construction and servicing Ham gear.

Learn
Ham Radio
the Easy Way



AM XMTR

R-F Signal Generator



All the necessary parts and simple, easy to understand instructions accompany each RTTA Kit, which is designed and engineered to meet the most rigid requirements.

Correspondence courses or resident instruction are available for both the beginner and for the advanced student in all phases of Radio and Electronics.

for information write to:

Radio Television Training of America ⁷³⁻⁶

52 East 19th Street New York, N. Y.

Name

Address

City..... State.....



DELUXE HAM BENCH

\$139⁹⁵

Formica Top—AC & RF Outlets

Send for brochure.

ALDEN

PRODUCTS COMPANY

174 N. Main Street, Brockton, Massachusetts

NEW SURPLUS BUYS

Low-Pass Audio Filter & Output Transformer.

Filter cutoff 2500 cps, for use between audio stages, also works in speaker leads. Output trans. for 6V6 to speaker. 2 1/2" x 3 1/4" x 4 1/4". 4 lbs. \$1.49

Power Transformer, 330-0-330V. 100 ma., 5V. 3 Amps, 6.3V. 5 Amps. Herm. sealed. For R-48/TRC-8 Rcvr. 4" x 5" x 5" 13 lbs. \$2.50

Audio Output Transformer, 8000 ohms P-P to 4-8-15-500 ohms. 20 watts. 3" x 3 1/2" x 3 1/2". 4 lbs. \$2.00

Scope Transformer, 1250V. 3 ma., 330-0-330V. 150 ma. 1.25V., .3 Amp., 6.3V., .9 Amp., 6.3V., 6.7 Amps. 3 1/4" x 4" x 3 1/4". 6 lbs. (P-2118) \$3.00

Superior "Powerstat." Input 115V. 60~. Output 0-115V. or 0-200V. 15 Amps. Less knob & dial. 25 lbs. \$14.75

3BP1 Cathode-Ray Tubes \$2.49

1μf 3000V. Capacitor. GE Pyranol 95¢

2μf 600V. Cap. "Tobe" 60¢; 2 for \$1.00

10μf 600V. Cap. 95¢

Feedthru Capacitor 250μf 500 volts mica 15¢

4μf 330V. AC Capacitor 60¢; 2 for \$1.00

ART-13 Power Plug U-7/U \$2.00

Dummy-Load Resistors 112 ohms 1% 50 watts deposited carbon, glass enclosed. 2 in parallel give 56 ohms, 100 watts, 2 lbs. each 79¢

AC Milliammeter 0-500 ma. 25-125 cps. 2" round Weston \$1.95

Selenium Rectifier, 55V. AC input. 10 Amps. Oil-filled, sealed can 6" diam. x 8 1/2" 15 lbs. \$5.95

Astatic 400-D Phono Pickup Arms 59¢

BC-683 Receivers. 40 lbs. \$29.95

Printed Circuit Boards, loaded with germanium diodes, resistors, capacitors, coils, neon bulbs. Priced at 60¢, 75¢, 90¢. Order several sizes. We guarantee your moneys worth. Board with about 70 diodes \$1.25

KITS:

10 Precision Gears, Stainless or aluminum, various sizes, from 1" to 4" \$1.00

20 Assorted Miniature Tube Shields \$1.00

Jeff-Tronics

4722 Memphis Ave.
Cleveland 9, Ohio

Add 35¢ handling charge on orders under \$2.00. Prices are F.O.B. Cleveland, Ohio. Please add sufficient postage. All excess will be returned.

Another QUALITY MADE COMPACT ANTENNA

THE FIRST MULTIBAND COAXIAL ANTENNA for 6-10-15-20 Meters



**needs no ground
plane radials—**

Ideal for . . .

Emergency nets and citizens band wherever omnidirectional coverage is desired.

Campers and apartment residents or *wherever* space is a problem.

A second antenna for low angle radiation.

The New C-4 features . . .

- Full electrical half waves on all bands . . . eliminating the need for awkward ground plane radials.
- Easy, inexpensive mounting with regular TV hardware such as simple chimney mount as shown.
- Compactness . . . only 12' over-all height.
- End-loaded to provide maximum radiator current for maximum radiation.
- Quick installation . . . about ½ hour.
- Power rating . . . 300 watts AM.
- Feed line . . . RG58AU or equivalent.
- SWR . . . less than 1.5 to 1 at resonance.

Model C-4
amateur net **\$34.95**

Two other 6-10-15-20 meter antennas:

Model B-24 Four Band Beam
Element length 11' — boom length 5'
Turning radius 7'
amateur net **\$54.95**

Model M-4 Four Band
Mobile • 5'-3" high
Fits all standard mounts
amateur net **\$16.95**

The above antennas are also available for 6-10 or citizens band operation.

Write for literature and the name of your nearest Mini-Products distributor. Patents pending

Mini-Products, Inc.

1001 West 18th Street
Erie, Pennsylvania

SPECIALISTS IN COMPACT ANTENNAS

Advertisers Index

Alden	69
Algeradio	63
Alltronics-Howard	49
Ameco	55
Arrow Electronics, Inc.	73
Barker & Williamson	49
Barry Electronics	67
British Radio Electronics Ltd.	68
Candee	65
Centimeg	68
Central Electronics	7
Clark	52
Clegg	2, 27
Columbia	45
Curta	10
Cushcraft	56
Ebco	5
EICO	11
Electro-tone	53
Elmac	58
Epsilon	57
E-Z Way Towers	13
Finney	6
Fulton Radio	47
Globe Industries	56
Gonset	Cover II
Graham	56
Ham Novelties	43
Heath	19
Hi-Par	50
House of Antennas (J-Beams)	45
International Crystal	1
Jefftronics	69
JSH	45
Lafayette Radio	23
L-W Electronics	45
Mini-Products	70
Mission	47
Mobiliers	43
Multi-Products	58
National Radio	Cover IV
Neil	63
Peterson	Cover III
P & H	57
Radio Bookshop	60
Reyco	56
Rider	15
Ritco	43
RTTA	69
Spera Electronics	52
Subscriptions	6
TAB	71
Tapedcode	50
Tapetone	43
Technical Material Corp.	25
Telrex	49
Texas Crystals	59
U. S. #1 Electronics	58
Vanguard Electronic Lab	59
VHF-UHF Associates	53
Western Radio (San Diego)	55
World Radio Labs	21

"TAB" FOR THE BEST KITS!**GENERAL PURPOSE—PNP—COMPUTER GRADE!**

Use as Amplifier—Oscillator—HiFi Logic—Servoamp—Power Supply Pulse Amplifier or High Current Switch Veb. Vcc. Veb Approx 40V GP3C rated 300 Milliwatts 65¢, @ 10 for \$5, 100 for \$39 GP10C Rated 1 watt 90¢, 6 \$5, 100 \$63

2N155 \$1.39, 2N176 \$1.80, 2N177 \$1.20
2N178 \$1.75, 2N247 \$1.50, 2N255 \$1.20
2N270 \$.95, 2N274 \$1.25, 2N408 \$.80
2N544 \$1.20, 2N578 \$1.80, 2N579 \$2.20
2N581 \$1.25, 2N582 \$2.10, 2N174 \$8.50
2N443 \$.650, 2N670 \$1.60, 2N671 \$2.

NEW BATTERY CHARGER BC6-12V FOR 6V OR 12 VOLT BATTERIES TRICKLE & FULL CHARGE up to 4 AMP

Charges 6 & 12 volt batteries Built BC6-12VB...\$10.00 BC6-12VK preassembled Kit 7.50 Same except rated 2.5A BC612AB 8.00 BC6-12AK Presassembled Kit 6.00

**!!! TUBE SPECIAL !!!**

4X150D—Removed from Govt. equipment. Tested. \$3 ea., 2 for \$5. Filament Xfmr. \$2. First come, first served.

"TAB"—THAT'S A BUY. BARGAINS

New Variacs/or equiv 0-135V/7.5A. \$15.30
New Variacs/or equiv 0-135V/3 Amp \$10.65
New Variacs/or equiv 0-132V/1.25A. \$7.25
RF-MTG GE/475 Ma & 5 Amp \$4 @, 2/\$7
DC-METER Dejour 800 Ma/2 1/2" \$3 @, 2/\$5
DC MTR 100Ma/2 1/2" \$3 @, 2/\$5
RF-HTR Weston 750Ma/TC.... \$4 @, 2/\$6
DC-METER One Ma/4" Rd. \$5 @, 2/\$8
TRS PWR DIODES* up to 3amp. .4 for \$1
TRS PWR DIODES* up to 5amp. .4 for \$1
*Heat sink mounted.
SNOOPERSCOPE TUBE 2".... \$5 @, 2/\$9
MINI-FAN 6 or 12VAC/60 Cys \$2 @, 3/\$5
NEW PRINT CKT-PANEL, 11x12x.062" \$2
1N34A 45¢ @, 15/\$5; 1N35 \$1; 1N38 70¢ @;
XTAL OVEN—115V&Thermostat.... \$2
Blower 24VDC/100CFM..... \$3.98
Xmitting Mica's .006 @ 2500V, 5 for \$1.00
4-1000A Air Socket, less chimney.... \$9.95
829B Socket 85¢, 183 Socket..... \$1
4x150 Ceramic/LOKTAL..... 2 for \$1.00

NEW "VACDAC"(R) SILICON TUBE REPLACEMENTS WITH BUILT IN RF SURGE & SERIES BALANCING PROTECTION

TYPE VRMS/PIV	AMPS	PRICE
ST866	5000/10400	0.3 \$20.00
ST816	5000/7000	0.3 \$16.00
ST5R4	1900/2800	0.5 \$15.00
ST5U4	1120/1600	0.6 \$ 8.00

**SILICON DIODES 750MA* TOP HATS**

General Purpose	400 PIV at 300 MA	Special 2 for \$1	20 for \$7
rms/piv 17/25 14c	rms/piv 35/50 19c	rms/piv 70/100 29c	rms/piv 140/200 34c
rms/piv 210/300 43c	rms/piv 280/400 55c	rms/piv 350/500 70c	rms/piv 420/600 \$1.00
rms/piv 490/700 \$1.25	rms/piv 560/800 \$1.50	rms/piv 630/900 \$1.70	rms/piv 700/1000 \$2.00

Low Priced * T200 SILICON DIODES rated 380piv/266rms @ 200Ma @ 100°C 36¢ each; 10 for \$3.25; 100 for \$27;

***CAPACITOR INPUT DERATE 20%; (\$5 or more this item we pay P.P./U.S.A.) SPECIAL! TRANSISTORS & DIODES!!!**

Factory Tested & Guaranteed!
FULL LENGTH LEADS
2N123 PNP 45¢, 12 for \$5, 100/\$37
2N292 NPN 45¢, 12 for \$5, 100/\$37
2N293 PNP 45¢, 12 for \$5, 100/\$37
2N223 PNP 80¢ 100/\$65
2N597 PNP \$1.90 6/\$10
2N598 PNP \$1.90 6/\$10
2N599 PNP \$3.50 3/\$10



"SUNTAB"® SELENIUM PHOTOCELL
2BP 75µa 3/4x3/4" c40 @. 11 for \$4
5AP 1" Dia., 5BP/Sq & Rect 220µa. c55
15AP 750µa, 1 3/4" Dia. \$1.45 @. 4 for \$5
10BP 350µa, 1-11/16" Rect. c75 @. 10 for \$7
10CP 750µa, 1 7/8x1 1/8" c1.45 @. 4 for \$5

"TAB" THAT'S A BUY

"TAB" Tubes Factory Tested, Inspected, Six Months Guaranteed! No Rejects! Boxed!

GOVT & MFGRS Surplus! New & Used

0A289	6BZ7 1.25	4375
0A380	6C445	4549
0B265	6C569	50L669
0C370	6C6 1.08	RK59 1.39
0D350	6C8 1.08	RK60 1.17
0Z479		HY69 2.20
1A790	6CB689	7581
1B399	6CD6 1.49	HY75 5.00
1L482	6CF685	83V95
1R4 5/\$1	6CL6 1.40	

We Swap Tubes! What Do/U Have?

1R578	6CB689	4PR60A 37.50
1S478	6CG8 1.12	4-125A 27.50
1S568	6CM679	4X150G 15.00
1T485	6CS670	4X250B 41.00
1T595	6CU6 1.29	4-400A 41.75
1U4 6/\$1	6D699	4E27A 39.00
1U575	6E579	250TL 19.45
1X299	6F4 2.49	307A 2/\$1
2C39A Q	6F563	316A 5/\$1
2C40 5.50	6F699	VR92 5/\$1

Send 25¢ for Catalog!

2C43 6.50	6F799	388A 3/\$1
2C51 2.00	6F8 1.39	350A 2.45
2D2165	6H659	350B 1.75
2E22 1.75	6J4 1.72	371B95
2E24 1.90	6J559	\$146 3.90
2E25 2.50	6J659	416B 16.00
2E26 2.75	6J799	450TH 43.00
2E30 Q	6J8 1.39	450TL 43.00
2E35 1.60	6K659	460 11.50
2K25 9.75	6K779	

All Tubes Stocked at Low Prices!

2K26 34.00	6K899	703A Q
2K28 30.00	6L6 1.19	707B 3.50
2V3 2/\$1	6SN772	715C 10.90
2X248	6T898	717A 5/\$1
3A470	6V6GT90	723AB 5.00
3A5 1.00	6X549	725A 2.75
3AP1 5.95	12AT659	803 3.50
3BP1 3.99	12AT789	804 8.85
3C24 3.50	12AU663	805 6.00
3D25 3.95	12AU760	

We Buy!

3E29 6.00	12AX779
3Q468	12AY7 1.29
3Q586	12B495
4-65A 13.50	12BA665
4-125A 27.50	12BA799
4-250A 34.00	12BD659
4X150A Q	12BE659
4X250 36.00	12BH679
4X500 37.00	12BH799
5AP1 2.95	12BY7 1.00

We Sell!

807 1.10
5/\$5, 10/\$12
811 3.45
811A 4.41
812 3.30
813 9.95
815 1.75
82699

Wanted Test Sets and Equipment

5BP1 7.95	12BZ799	828 9.00
5BP4 7.95	12H675	829B 8.00
5CPI 4.99	12J569	832A 6.00
5CP7 9.00	12J769	833A 36.00
5R4 1.00	12J8 1.35	837 2/\$2
5T490	12K889	866A 2.45
5U499	12SA769	954 10/\$1
5V489	12SC789	955 3/\$1
5Y360	12SF569	957 3/\$1
5Z389	12SG789	958A 2/\$1

Send 25¢ for Catalog!

15GP22 89.00	12SH789	991 5/\$1
6A7 1.00	12SJ775	1614 2.75
6A899	12SK775	1619 5/\$1
6AB459	12SL779	1620 2.00
6AC772	12SN769	1625 3/\$1
6AG565	12SQ769	1626 5/\$1
6AG775	12SR769	1629 4/\$1
6AK569	15E 1.19	2050 1.25
6AL559	15R 4/\$1	5517 1.25
6AQ566	FG17 Q	5608 3.95

Top \$\$\$ Paid for 304TL, 813, 811A, 812A Tubes

6AR6 1.95	19T8 1.16	5618 3.25
6AS7 3.49	24G 3.50	5651 1.35
6AT6 2/\$1	25A6 1.19	5654 1.20
6AU679	25A7 2.19	5656 4.25
6B8 1.35	25C581	5663 1.15
6BA659	25L672	567090
6BE659	25T 4.00	5686 1.75
6BG6 1.49	25Z572	5687 1.15
6BH679	25Z675	5691 4.70
6BJ672	26A7 3.69	5725 1.95

Top \$\$\$ Paid for XMTTR Tubes!

6BK799	FG27 8.28	5732 2.00
6BL7 1.35	HV27 19.39	5736 85.00
6BN469	28D789	5749 1.95
6BN6 1.08	FG33 15.00	5750 2.75
6BN7 1.99	EL34 3.49	5751 1.25
6BQ6 1.19	35A569	5814 1.20
6BQ799	35L659	5879 1.20
6BX7 1.11	35T 4.49	5894 \$12.00
6BY5 1.19	35Z5 1.25	
6BZ691	RK39 2.99	No See—Write!

"TAB" TERMS: Min Order \$3—25% with order F.O.B. New York. Ten day guarantee, price of mdse. only. Our 17th year.

Prices shown are subject to change.

111G5 Liberty St., N. Y. 6, N. Y. • RE 2-6245

GTD! HIPOWER-ROUND-TRANSISTRS Factory Tested

***MFG in U.S.A.
2N277 or 2N441 @ \$2.25,
2N278 or 2N442 @ \$3.75,
2N173 or 2N443 \$5.00 @ 4/\$16
(\$10 or more this item we pay P.P./U.S.A.)

**NEW POWER CONVERTER**

12VDC to 500VDC up to 200MA
100 Watts; Tap at 250VDC



*Type C1250E \$35

TYPE C650E FOR 6VDC INPUT \$35
12VDC to 250VDC up to 150MA
Type C1225E \$30
C625E for 6VDC input \$30

"TAB" TOROID XFMRs for TRANSISTOR POWER CONVERTERS!
T6-500E/6VDC Inpt. 500VDC & Tap. Max 200Ma \$15.
T12-50"E/12VDC Inpt. 5"0VDC & Tap. Max 200Ma \$15.
T6-250E/6VDC Inpt. 250VDC. Max 150Ma \$14.
T12-250E/12VDC Inpt. 250VDC. Max 150Ma \$14.

Leece Neville Charger Systems "SILTAB" Silicon Rectifier Replacement

Non-Aging Hermetically Sealed FOR 6 or 12VDC @ 100A, Type YJ9 \$24

SELENIUM F.W. BRIDGE RECTIFIERS

DC AMP	18VAC	36VAC	72VAC	130VAC
1/2	\$1.00	\$1.90	\$3.85	\$5.00
1	1.30	2.00	4.90	8.15
2	2.15	3.00	6.25	11.10
3	2.90	4.00	8.60	13.45
6	4.15	8.00	18.75	31.90
10	6.10	12.15	26.30	41.60
12	7.75	14.90	30.95	43.45
20	12.85	24.60		
24	15.00	29.45		

Write For Rectifier Catalog

Each "TAB" Kit Contains The Finest Selection!!!!

- Kit 75 Mica Condensers
- Kit 8 Crystal Diodes
- Kit 200ft Hook Up Wire
- 4 Rolls, 50ft/ea. Ass'd. Color
- Kit 100 Ceramic Condensers
- Kit 5 FT243 Xtal Holders
- Kit 5 Microswitches
- Kit 8 Xtal Osc-Blanks
- Kit 4 Ass'd Rectifiers
- Kit 5 UG/Connectors
- Kit 100 Self/Tap Screws
- Kit 4 Selenium "Suncells"
- Kit Adj Wire Striper & Cut
- Kit Hi Gain Xtal Mike
- Kit 6 ea Photoplugs & Jacks
- Kit 2 pair SO239 & PL59
- Kit 12 Binding Posts Ass'd

Order Ten Kits—We Ship Eleven!!! ONE EACH ABOVE KIT ONLY 99¢

GTD! POWER-DIAMOND-TRANSISTORS Factory Tested

***MFG in U.S.A.
Replaces Medium & HiWattage Types
2N155, 2N156, 2N234,
2N256, 2N307, 2N554
GENERAL TO 3GP 80¢ @, 20 for \$15
PURPOSE 100/\$65
(\$10 or more this item we pay P.P./U.S.A.)

8 TOPHAT SILICON DIODES \$1 EXPERIMENTERS KIT, USE AS STABISTORS, ZENOR DIODES METER PROTECTION CLIPPER & RECTIFIERS! \$10 VALUE.

DIAMOND BASE MICA MTG KIT. . \$.30
ROUND BASE MICA MTG KIT. . \$.30
DELCO POWER HEAT SINK WITH PINS 80 SQ" \$1.25
KIT DIODES COMPUTER. 20¢, 8/\$1
KIT TRNSTR NPN or PNP. 39¢ @, 3 for \$1
1N34A DIODES 23¢ @, 10 for \$2, 100/\$18
(\$10 or more this item we pay P.P./U.S.A.)

Send 25¢ for Catalog

BULLSEYE BUYS at ARROW!

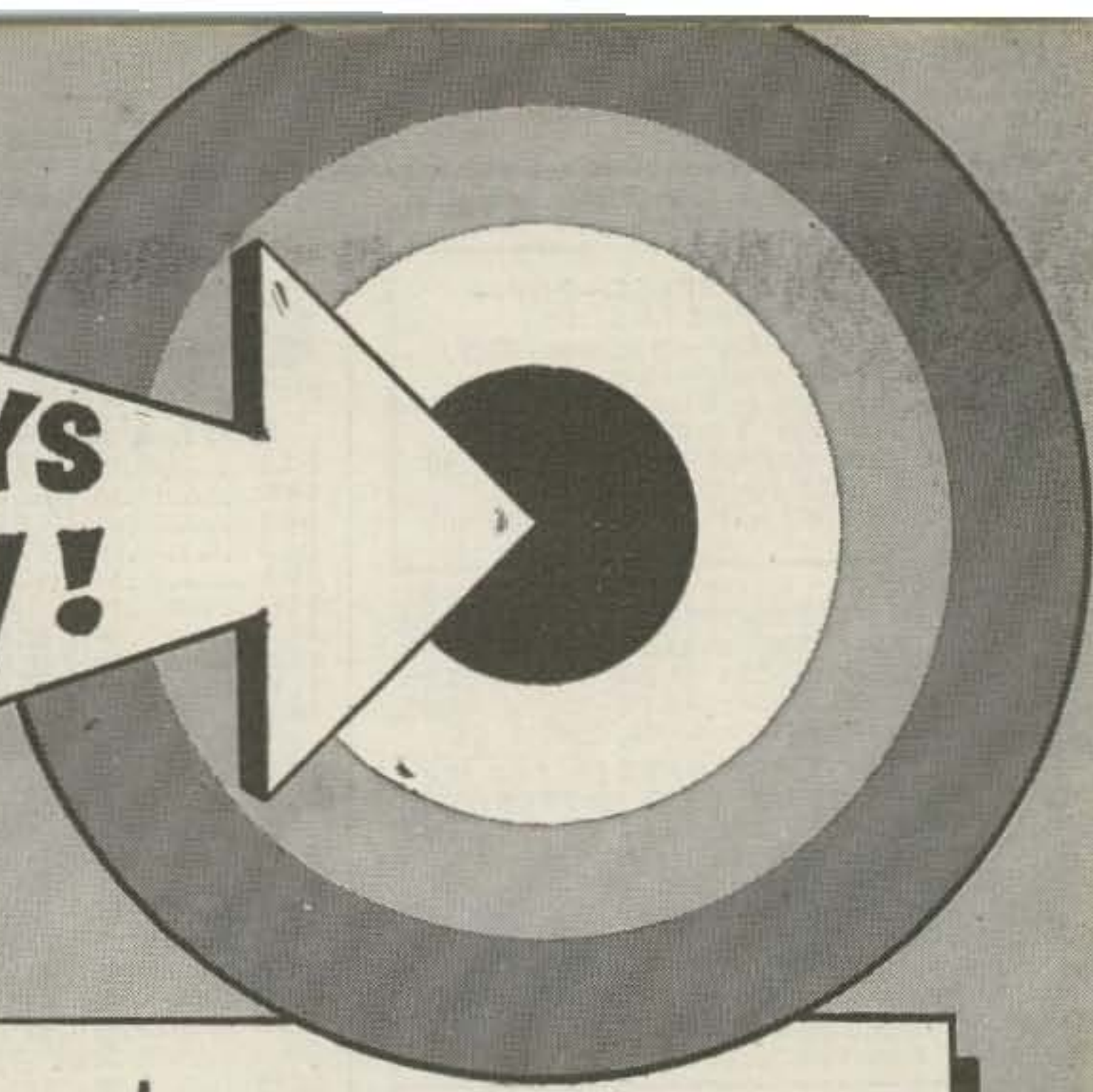

AMERICAN GELOSO V.F.O.'s

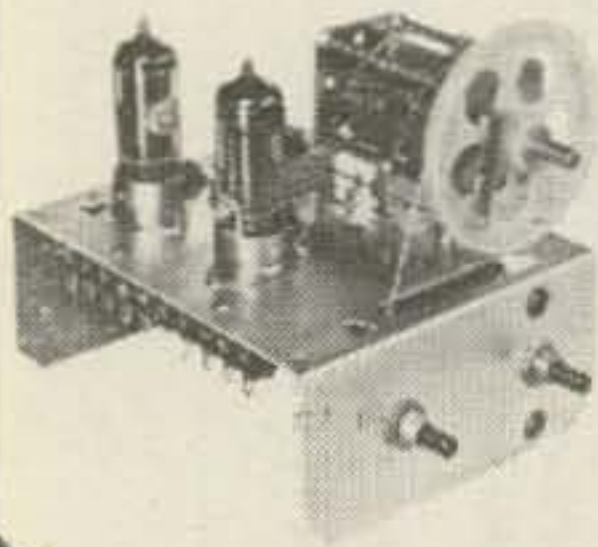

Wired, tested, calibrated, ready for use. Mod. 4/104 for driving one 807 or 6146 final in AM or CW under Class "C" conditions.

Mod. 4/102 for driving two 807's or 6146's final. Has 5 bands. Supplied with Mod. 1640 dial ass'y.

Mod. 4/103 for 144-148 mc bands. Combines VFO primary freq. of 18 mc with xtal fundamental freq. of 12 mc. Supplied with Mod. 1647 dial ass'y.

Mod. 4/104, 4/102 or 4/103 less tubes and xtal, each \$29.95

PRECISION PLANETARY-VERNIER

for exceptionally fine tuning

Superb craftsmanship by Jackson Bros. of England. Ball bearing drive, 1/4" dia. shaft, 1 1/8" long, 6:1 ratio, Vy FB for fine tuning. Easily adaptable to any shaft. Comparable value — \$5.95.

Amateur Net \$1.50 ea.
10 for \$13.50

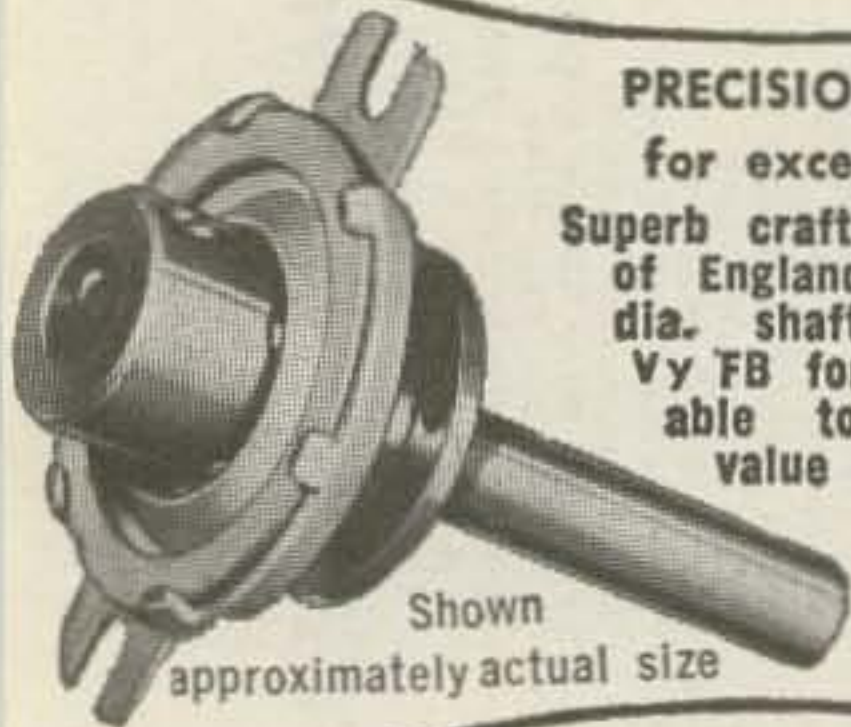

Shown approximately actual size

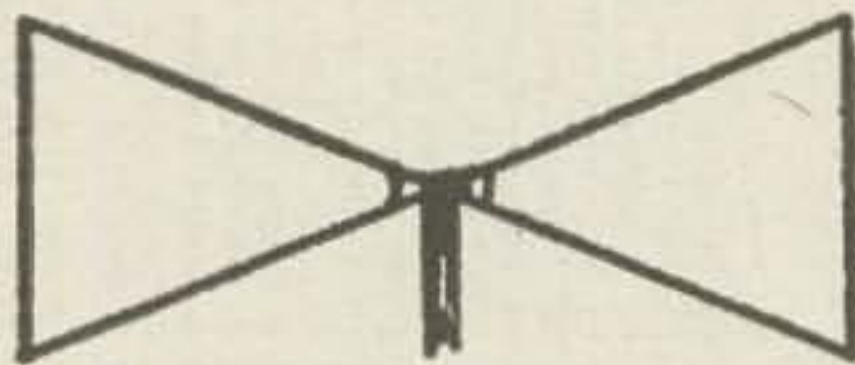

"Wonder Bar" 10 Meter Antenna

As featured in Nov. 1956 QST. Complete with B & W 3013 Miniductor. Only 8 ft. long for 10 meters. Wt. 5 lbs.

Amateur Net \$7.85



Versatile Miniature Transformer

Same as used in W2EWL SSB Rig — March 1956 QST. Three sets of CT windings for a combination of impedances: 600 ohms, 5200 ohms, 22000 ohms. (By using center-taps the impedances are quartered.) The ideal transformer for a SSB transmitter. Other uses: interstage, transistor, high impedance choke, line to grid or plate, etc. Size only 2" h. x 3/4" w. x 3/4" d. New and fully shielded.

Amateur Net \$1.39

3 for \$3.49 10 for \$10.75
ARROW Authorized distributor of HEATHKIT equipment

AGS-RT-101 CITIZENS BAND TWO-WAY RADIO



No license required. Complies with part 15 of FCC rules on low power units. 1.5 mi. average range on land, up to 5 mi. on water. Xtal controlled XMTR, Rec. Sens. 1 μ V. Each unit complete with transmitter-receiver, AM radio, leather carrying case, ear-phones, antenna, 6 penlight batteries.

\$70.00 ea. 2 for \$139.50

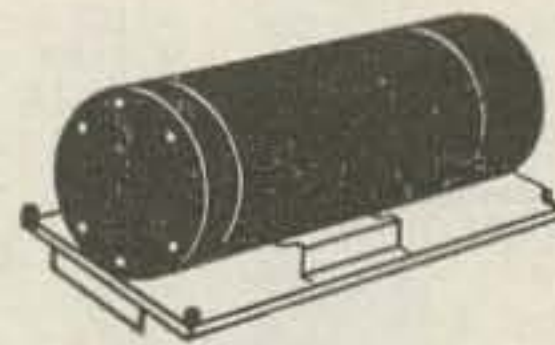

DYNAMOTORS

Brand new, recent military production, high efficiency, compact.

12 Volt Model

Rated output: 625 vdc @ 225 ma. 9" long, 5" dia. wt. 16 lbs.

\$12.95

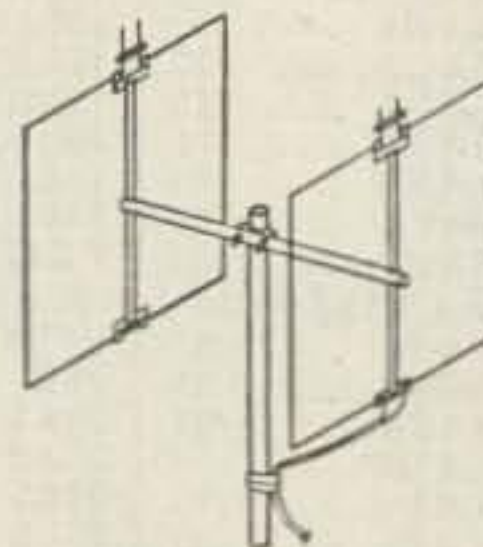

THE COR-MAC 2 METER CUBICAL QUAD ANTENNA

Complete 2 meter quad antenna kit, machined from the finest alloys of aluminum... assemble it yourself with only pliers and a screwdriver. This 2 meter cubical quad was derived from the basic design concept proved so successfully for the 10 and 20 meter beams.

2 meter Kit \$12.50

MAIL ORDERS PROMPTLY PROCESSED
SAME DAY SHIPMENT FROM STOCK

ARROW ELECTRONICS, INC.

65 Cortlandt Street, New York 7, N. Y. • Dlgy 9-4730
525 Jericho Turnpike, Mineola, N. Y. • Ploneer 6-8686

SAY YOU SAW IT IN 73

TO SAVE C.O.D. CHARGES, PLEASE INCLUDE SUFFICIENT POSTAGE WITH YOUR ORDER. ANY EXTRA MONEY WILL BE RETURNED.

ALL PRICES F.O.B. N. Y. C.
Arrow's Export Dept. Ships To All Parts Of The World!
Prices Subject To Change Without Notice.

*Unconditionally
Guaranteed*

... the Mark
of the Maker's
Confidence in
His Product



PRs are built to PERFORM . . . under good conditions and bad. They have that extra measure of stability and dependability BUILT-IN . . . that *plus* of rugged precision that guarantees years of unfailing service. Thousands of pre-war PRs are still performing . . . *still right on the kilocycle!* No wonder PRs can be UNCONDITIONALLY GUARANTEED.

40 and 80 Meters, PR Type Z-2, ± 500 Cycles.....	\$2.95 Net	6 Meters, PR Type Z-9A, 50 to 54 Mc., ± 15 Kc.....	\$6.95 Net
Third Overtone, PR Type Z-9A, 24,000 to 24,666 and 25,000 to 27,000 Kc., ± 3 Kc.....	\$4.95 Net	Citizens Band, PR Type Z-9R, .005%	\$2.95 Net

PR

Crystals



USE **PR** AND KNOW WHERE YOU ARE

PETERSEN RADIO COMPANY, INC.
2800 W. BROADWAY • COUNCIL BLUFFS, IOWA

EXPORT SALES: Royal National Corporation, 250 W. 57th Street, New York 19, N. Y., U. S. A.

with built-in PRODUCT DETECTOR

NC 270



THE "COSMIC BLUE" NATIONAL'S NEW HAMBAND RECEIVER

This newest and finest precision double conversion amateur receiver with 6 meter coverage, brings you an ease of sideband tuning previously available only in the most expensive equipment. The NC-270 features an exclusive "Ferrite Filter" for instant upper-lower SSB selection and a degree of selectivity to conquer even the toughest AM and CW signal conditions. The solid $\frac{1}{8}$ " steel panel, ceramic coil forms, double-spaced tuning gang, and full ventilation cabinet combine to give mechanical and thermal stability that will surprise even the most critical operator. Even the color of the NC-270 is outstandingly different, National's new duo-tone "Cosmic Blue." Write for detailed specifications.

Only \$24.99 down*

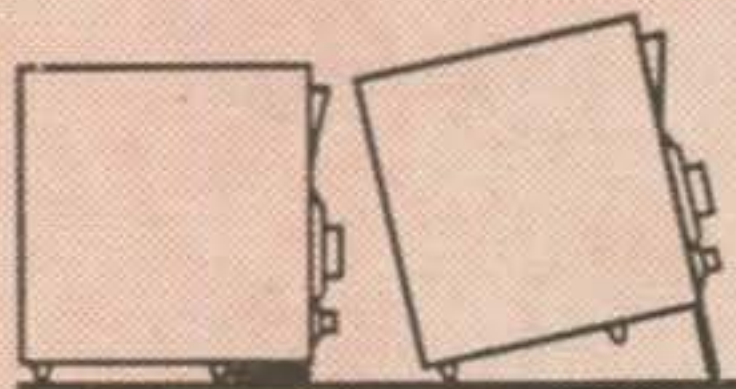

And National Radio's patented "Flip Foot" makes operating the NC-270 so easy.

Suggested cash price. \$249.95. NTS-3 Matching Speaker \$19.95 (slightly higher west of the Rockies and outside the U.S.A.). *Most National distributors offer budget terms and trade-in allowances.

NATIONAL RADIO COMPANY, INC.



A WHOLLY OWNED SUBSIDIARY OF NATIONAL CO., INC.

MELROSE 76, MASS.

Export: AD AURIEMA, INC., 85 Broad St., New York, N. Y.

Canada: CANADIAN MARCONI CO., 830 Bayview Ave., Toronto 17, Ont.

SPECIFICATIONS SUBJECT TO CHANGE WITHOUT NOTICE