

THE  
HX-500  
TRANSMITTER

TECHNICAL  
DESCRIPTION  
AND  
OPERATING  
INSTRUCTIONS

# HAMMARLUND

The Hammarlund Manufacturing Co., Inc.  
460 West 34th Street, New York 1, N. Y.

International Division: 13 East 40th Street, New York 16, N. Y.

# THE HX-500 TRANSMITTER

INSTRUCTION AND SERVICE INFORMATION



ESTABLISHED 1910

ISSUE NO. 1

In order to receive the full unconditional 90-day warranty against defective material and workmanship in this receiver, the warranty card must be filled out and mailed within two weeks of purchase.

Please refer to serial number of equipment in correspondence, and refer to inside back cover for terms of warranty.

**THE HAMMARLUND MANUFACTURING COMPANY, INC.**  
460 West 34th Street, New York 1, New York, U.S.A.



## INTRODUCTION

The HX-500 Exciter-Transmitter is a self contained unit designed with your present and future requirements in mind. The transmitter is completely self contained; employing 21 tubes (plus four semiconductor diodes), and requires only the addition of a suitable mike, key, or bug and suitable antenna system for immediate "on the air" operation.

This Transmitter-Exciter covers, 80, 40, 20, 15 and 10 meter amateur bands by means of an eight position rotary bandswitch. Four bandswitch positions are provided for complete coverage of the 10 meter band and the built-in VFO covers a range of 500 KC's. The eight crystals needed for complete band coverage are supplied. The rotating drum, illuminated slide rule dial is calibrated to indicate better than 10 KC's and the tuning knob skirt can be read to better than 200 cycles. One rotation of the frequency knob covers two divisions or 20 KCS on the illuminated dial drum.

The unit is capable of transmitting the following types of signals: LSB, USB, DSB, CW, FM, and FSK.

The power output on SSB is 70-100 watts; 70-100 watts on CW, FSK, FM and 17-25 watts on DSB (AM).

The carrier suppression on both USB and LSB is greater than -50 db and the unwanted sideband is rejected by more than -50 db. Spurious frequencies generated within the unit are suppressed to a level of -50 db or more. The intermodulation distortion

products have been suppressed beyond the -30 db level.

The transmitter output pi-network has been carefully designed to match a 52 ohm transmission cable impedance and suppress harmonic TVI.

A logarithmic type of carrier level indicator provides a very simple yet adequate means of tuning up and continuously monitoring the transmitter. The VOX circuit adjustments (Sensitivity, Delay and Anti-Trip) are located on the front panel.

The single sideband signal is generated in the HX-500 Transmitter-Exciter by means of a highly stable 60 KC oscillator whose signal is fed into a carefully balanced diode modulator and subsequently applied to a series of cascaded overcoupled and undercoupled tuned circuits (with carrier rejection trap) which provides the necessary unwanted sideband rejection. The choice of LSB, USB, or DSB transmission is determined by the position of the function switch which shifts the resonant frequencies of the 60 KC tuned circuits to provide the proper bandwidth for the desired mode of operation.

All of the controls that are required for proper tune up and operation of the Transmitter-Exciter are provided on it's front panel and these controls are logically grouped for maximum operating ease.

The HX-500 was designed with you in mind. You will find many hours of pleasure in operating this truly fine communications instrument.

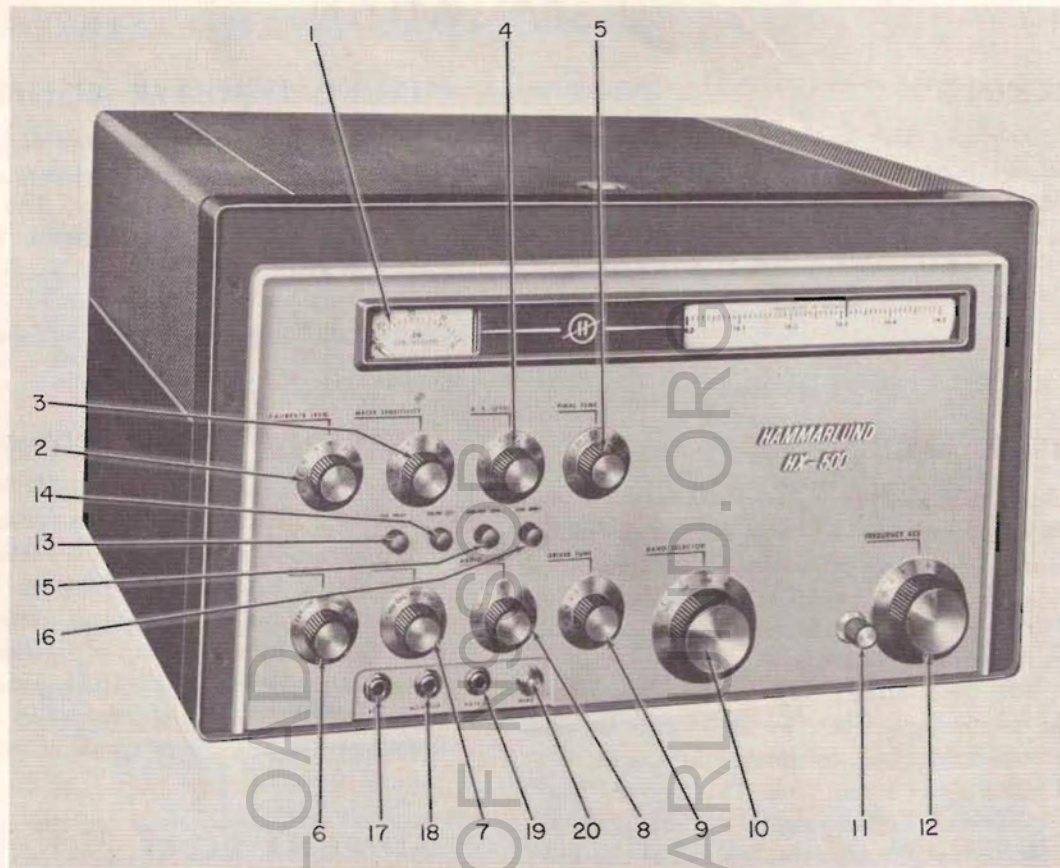

Figure 1. The HX 500 Transmitter

### LOCATION OF CONTROLS

- |  |  |
|--|--|
| 1. R.F. Output Level Meter                         | 11. Tuning Dial Drag or lock                   |
| 2. Calibrate Level Control                         | 12. Frequency Control                          |
| 3. Meter Sensitivity Control                       | 13. VOX Delay Adjustment                       |
| 4. R.F. Level Control                              | 14. FSK -FM $\Delta f$ Adjustment              |
| 5. Final Amplifier Tuning Control                  | 15. Anti-Trip Sensitivity Adjustment           |
| 6. Function Switch Selector (Type of Transmission) | 16. VOX Sensitivity Adjustment                 |
| 7. Operations Switch Selector                      | 17. Key Jack (CW -FSK 40 cycle Identification) |
| 8. Audio Level Control                             | 18. Monitor Jack                               |
| 9. Driver Tuning Control                           | 19. Patch Jack                                 |
| 10. Band Selector                                  | 20. Microphone Connector                       |



## INSTALLATION

### UNPACKING

After unpacking the transmitter carefully, make sure that all tubes, associated tube shields, and pilot lamps are properly seated in their respective sockets. Inspect the unit for any signs of damage during shipment and carefully read all tags and labels for any special instructions before discarding them.

### MONITOR JACK

The microphone and key connections to the transmitter are located along the bottom edge of the transmitter panel. A standard microphone connector such as the Amphenol type 75-MC1F or equivalent is required to connect the microphone to the transmitter. Any high impedance microphone, either crystal or dynamic, will give satisfactory results when used with this transmitter. The key or "bug" is connected to the front panel receptacle by means of a standard two contact phone plug. The key or "bug" may be connected to the remote control plug, located at the rear of the chassis, instead of the front panel if desired. See Fig. 2 for remote key connections on the 14 prong plug located at the rear apron of chassis.

### MICROPHONE & KEY CONNECTIONS

The monitor jack provides a means of listening to the received signals. Any headset fitted with a standard two conductor phone plug can be used. When the phones are plugged into the receptacle, the communications receiver speaker will be disabled, provided that the receiver output and speaker are wired as shown in Fig. 2.

### PHONE PATCH

The phone patch jack requires a standard two conductor phone plug. This input receptacle is connected directly across the high impedance audio level control. Any of the phone patches available should be useable when the output is fed into this jack (on the assumption that sufficient gain has been provided in the patch).

### 117 VOLT POWER CONNECTION

Before inserting the line cord plug into the power outlet, make certain that the power source is of the proper voltage and frequency. The Model HX-500 Transmitter-Exciter is designed to operate on 105-125 volts, 50-60 cycles A.C. Do not under any circumstances, connect this unit to a source of direct current as doing so will blow the fuse.

### ANTENNA CONNECTION

The output impedance of the HX-500 is 50 Ohms. A suitable RF cable and cable connector is RG-8/u coaxial cable with an Amphenol type 83-1SP or equivalent coaxial cable connector.

The selection of the type of antenna and coupler will depend upon the band of operation and the objectives of the user. The ARRL publications are an excellent source for information on the design and construction of various types of antenna systems.

### ANTENNA RELAY

The HX-500 is equipped with an internal antenna changeover relay. The typical Send-Receive connections are illustrated in Fig. 2. A standard phonograph plug is required for the receiver connections to the changeover relay contacts.

### RECEIVER AUDIO CONNECTIONS

In order to have the VOX relay control the signals from the station receiver's loud speaker, the HX-500 Transmitter must be connected to the station receiver as shown in Fig. 2. In many cases the blocking bias connections will be needed to put the receiver in standby in place of the "make and break" contacts as shown in the Figure.

### BLOCKING BIAS CONNECTIONS

A high impedance bias source (-100V.) is provided to silence the station receiver during periods of transmission. Pin 6 of the rear receptacle supplies this voltage when the VOX relay is energized, (transmit position) and grounded in the normally open position. Pin 7 is a suitable ground connection for running a shielded lead to the receiver if it becomes necessary to minimize RF pick up in the lead.

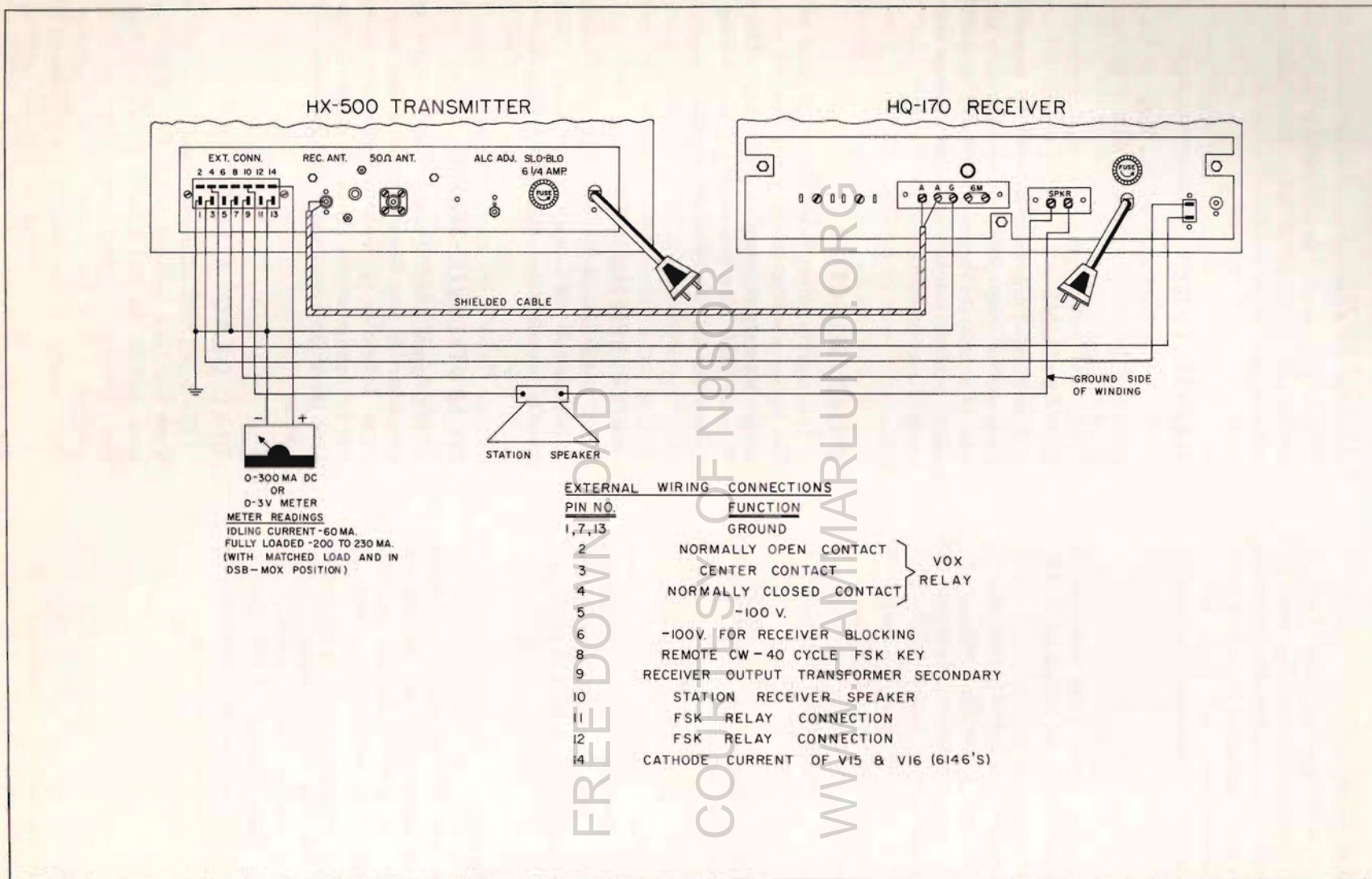

Figure 2. Typical Amateur Station Wiring





## FUNCTION OF OPERATING CONTROLS

### FUNCTION SWITCH

The Function Switch determines the type of emitted signal selected by the station operator. The HX-500 is capable of transmitting the following types of signals as indicated on the knob: LSB, USB, DSB (AM), CW, FSK, and FM.

### OPERATION SWITCH

The five position Operations Switch turns the AC power ON (Standby) and OFF, and includes the MOX, VOX, and Calibrate positions.

When manual control of the transmitter is desired, the MOX position is used. In the MOX position, the antenna and VOX relays are always energized and are completely independent of control by the VOX circuit knobs (VOX sensitivity, VOX delay and anti-trip).

In the VOX position, the transmitted output is controlled by the voice energy from the microphone. In this position, the antenna and VOX Relays are controlled by the adjustment of the VOX circuit controls. The proper setting of the VOX knobs is outlined in the Tuning Procedure.

In the calibrate position, the Antenna and VOX Relays are always in the de-energized position (receive). This position is used to monitor the transmitted signal in the communications receiver and is also used for zero beating the HX-500 signal frequency to an incoming signal or desired frequency.

### CALIBRATE LEVEL

A calibrate level control is included in the transmitter to adjust the amount of signal fed into the receiver from the transmitter in the Cal position. The Calibrate Level knob is adjusted so that the desired level of the transmitter output as observed on "S" meter of Receiver or the loudspeaker, (or headset connected to Monitor Jack) is sufficient for monitoring. A very limited amount of RF power is "leaked" from the final amplifier tank circuit to the receiver input via the Antenna Relay wiring.

### R.F. LEVEL

The RF Level control adjusts the gain of the 5.55 to 6.05 Mcs broadband amplifier. Optimum RF output on all bands is achieved with the adjustment of this control. This is usually set at 4 to 5.

### AUDIO LEVEL

The audio level control adjusts the amount of audio gain required to fully voice modulate the transmitter. This is usually set at 5.

### DRIVER TUNE

The Driver Tune knob adjusts both the 3rd mixer plate and driver plate tuned circuits to resonance at the frequency desired.

### FINAL TUNE

The Final Tune knob adjusts the output tank capacitor for maximum RF output. The knob skirt is marked to indicate the designated area on each band where maximum output can be obtained as observed on RF Level indicator.

### BAND SELECTOR

The eight position Band Selector control selects the proper combination of tuned circuits and the proper heterodyne crystal on each band. The Band Selector shaft also indexes the direct reading dial drum which indicates the band in use.

### METER SENSITIVITY

The meter sensitivity knob controls the amount of deflection of the output level meter. Clockwise rotation increases the sensitivity of the meter circuit.

### OUTPUT LEVEL METER

The Output Level Meter is used to tune up the transmitter to any frequency within its range. The meter indication is logarithmically proportional to the RF voltage across the 50 Ohm output. This feature gives the meter wider dynamic range of indication.

### DIAL DRAG & LOCK

The small knob adjacent to the Frequency tuning knob has been included in the HX-500 for the purpose locking the dial drive to a selected frequency and adjusting the tuning knob calibration. Clockwise rotation of this knob restrains the frequency knob from turning. It also enables the adjustment of dial action or torque required for personal preference of the operator.



## TUNING PROCEDURE

### GENERAL

The HX-500 Transmitter has been designed to give the utmost in quick and easy operation for the radio amateur operator. All operating controls are clearly identified.

The slide-rule type of dial is marked off to indicate every 10 kilocycle change in frequency on each of the eight direct reading bands. In addition to the 10 kcs markings, every band contains two heavy dot markings and two heavy diamond shaped markings. The dot markings indicate the outer limits of each amateur band in which authorized amateur communication is permitted. The diamond shaped markings have been included to show at a glance the outer limits of each amateur phone band. Since the 10 meter band extends over four band change positions, the markings are included only on the first and last of the four segments.

The frequency tuning knob and dial lock knob are connected to the variable capacitor located on the VFO sub-chassis by means of a spring loaded gear drive mechanism. Twenty five revolutions of the tuning knob covers a 500 Kcs band segment. The major markings on the frequency tuning knob are calibrated to indicate 1 Kcs changes in frequency and are sub-divided to indicate frequency changes of two hundred cycles between each small division.

To accurately set the transmitter to a specific frequency; for example 3962.4 Kcs., turn the tuning knob until the dial pointer indicates the nearest 10 Kcs point below the desired frequency e.g., 3960 Kcs and add two major divisions (2 Kcs) plus two sub-divisions (400 cycles) as indicated on the skirt of the tuning knob.

The HX-500 dial drive mechanism has been machined to extremely close tolerances in manufacturing; however, there will exist (as with all gear drives) a very small error between dial pointer indication and the tuning knob skirt calibration when knob markings are compared with the pointer indication at various points across the band. There are several other frequency determining elements which also contribute to the dial inaccuracies such as: VFO tuning capacitor and crystal tolerances.

As shipped from the factory the "O" marking on the knob skirt has been mechanically aligned to the high frequency end of all bands. Since most amateurs operate within a limited portion of a particular band, the knob markings should be indexed for the highest accuracy possible in the area of operation.

To correct for this knob runout, the knob may be

turned when the pointer remains stationary with the aid of the dial lock. The most accurate frequency calibration means readily available to the amateur is the crystal calibrator located in the communications receiver. Zero beat the transmitter as outlined below to the nearest 100 Kcs check point, lock the dial by turning the lock knob clockwise, then turn tuning knob until "O" on the knob coincides with the fiducial. This will require more force or torque than when dial is free running.

### CAUTION

The HX-500 Transmitter has been very conservatively designed to give reasonably long vacuum tube life. However, the life expectancy of vacuum tubes greatly depends upon how much use and abuse they get. All tuning adjustments should be made with the RF output level meter indicating less than -10 db for conservative operation (with the meter sensitivity set at its proper operating level). The final setting of the RF level control should be the last tune-up adjustment to be made.

## INITIAL TUNE-UP ADJUSTMENT

The Operating controls should be set as follows:

FUNCTION:	DSB
OPERATION:	OFF
AUDIO LEVEL:	0
DRIVER TUNE:	Set to "5"
BAND SELECTOR:	Set to desired band
FREQUENCY:	Set to desired frequency
CALIBRATE LEVEL:	Set to "5"
METER SENSITIVITY:	Set to "5"
R.F. LEVEL:	Set to "3"
FINAL TUNE:	Set to middle of desired band segment
VOX DELAY:	Counterclockwise position
FSK-FM- $\Delta$ F:	Set to middle of range
ANTI-TRIP SENSITIVITY:	Counterclockwise position
VOX SENSITIVITY:	Counterclockwise position
ALC (REAR APRON):	Clockwise position (OFF)





Turn the "Operations" switch to Standby and allow at least a one minute vacuum tube warm-up. Turn the "Operations" switch to MOX and adjust "Driver Tune" for maximum meter deflection. Then adjust "Final Tune" for the highest reading. Repeat adjustment of both Driver and Final Tune until Meter deflection cannot be improved.

## CW OPERATION

Turn the "RF Level" control until the "Level Indicator" reaches a maximum (saturates). Use the lowest setting of the control consistent with obtaining maximum output (knee of curve). Adjust "Meter Sensitivity" control to read "0" db.

Turn the "Function" switch to CW and key the transmitter via the "Key" jack.

## SIDEBAND OPERATION

After the transmitter has been tuned up to a desired frequency on CW, adjust the "ALC" control (on the rear of the chassis) so that the "Level Indicator" drops to -1 db or one half a division. Turn the "Function" switch to USB or LSB and the "Audio Level" control knob until the "Level Indicator" meter fluctuates or averages around the -10 db marking when talking into the microphone at conversational level. This setting will usually be 4 to 5 depending on the mike, speaking level and distance.

## VOX SENSITIVITY - VOX DELAY - ANTI-TRIP OPERATION

After the transmitter has been tuned up to the desired frequency with all of the larger sized knobs adjusted, the VOX Relay control knobs are brought into adjustment.

Turn the "Operations" switch to indicate VOX and turn the "VOX Sensitivity" knob clockwise until the VOX relay readily closes when talking into the microphone. It is desirable to keep the "VOX Sensitivity" as low as possible since any undesired background noise in the Ham Shack will trigger the VOX relay and you will be on-the-air. Usually the "VOX Sensitivity" knob will be near the center of its range or pointer vertical.

The de-energizing time for the VOX Relay is controlled by the "VOX Delay" control. This control is used to keep the VOX Relay closed during the quiet periods between words. Turn the "VOX Delay" control clockwise until the relay flutter between words is eliminated during the course of conversational speech. Excessive "VOX Delay" should be avoided. Leave at CCW position to start.

The "Anti-Trip" Control is used when the "Operations" switch indicates VOX operation. When the

Station receiver and speaker are connected for VOX operation (see Figure 2) the speaker "Anti-Trip" control is adjusted to a setting where the audio signal picked up by the microphone from the receiver's speaker will not energize the VOX Relay. This feature prevents the retransmitting of the incoming audio signals from your station receiver. Excessive speaker volume is capable of disabling the VOX Relay completely, therefore, minimum required gain should be used. Always adjust the receiver audio gain to the desired level before adjusting the "Anti-Trip" control.

## AM OPERATION

Turn the "Frequency" and "Band Selector" knobs to indicate any one of the authorized amateur phone bands. Tune the transmitter for maximum output as outlined in the general and CW sections with switches on DSB and MOX. Reduce the RF Output level to indicate -6 db on the "Level Indicator". Increase the audio level until there is a small fluctuation or kick upward in the output level meter pointer when talking into the microphone.

The carrier reference level can be established more precisely if an oscilloscope and audio oscilloscope are used to set up and monitor the output signal. If the carrier level is set too high, peak amplitudes are flattened before 100% modulation occurs. If the carrier level is set too low the maximum power output capabilities are not attained at 100% modulation.

## FSK OPERATION

FSK Operation is accomplished with the aid of V4 (12BY7) Reactance Tube Modulator which shifts the frequency of the 60 Kcs Carrier Oscillator by means of a change in modulator screen voltage (see Figure 3). Lowering the screen voltage lowers the frequency of the 60 Kcs Oscillator and raises the RF Output Frequency; conversely, raising the screen voltage raises the 60 Kcs Oscillator frequency and lowers the RF Output Frequency. The change in screen voltage is controlled by the Polar Relay keying employed for RTTY.

The amount of Frequency Shift is adjusted by the FSK Deviation control R140. When the Polar Relay is closed the screen voltage on the Reactance Modulator may be raised, lowered, or remain unchanged depending on the position of the arm of FSK Deviation Potentiometer. The zero position is located at (approximately) the center of its range. Clockwise rotation from the center position will decrease the screen voltage and lower the frequency of the 60 Kcs Oscillator. Counterclockwise rotation from the



middle position will increase the screen voltage and raise the frequency of the 60 Kcs Oscillator. The 40 cycle keyed identification frequency shift is accomplished by closing the key jack contacts.

Note that the 40 cycle keyed identification shift is not adjustable and when the CW key Jack contacts are closed the screen voltage is lowered thereby lowering the 60 Kcs Carrier Oscillator by 40 cycles and raising the RF Output Frequency by 40 cycles.

Tune up the transmitter as outlined on the preceding general and CW sections. Turn the Operation switch to Calibrate. Zero beat the transmitted signal in the communications receiver. Rotate the Function switch to indicate FSK and adjust the small "FM-FSK $\Delta$ F" knob for zero beat if necessary. This adjustment is made with both Polar Relay Contacts and key Contacts Open.

Close Polar Relay Contacts and vary the FSK Deviation Control for zero beat, then adjust in either direction from this position for the desired 850 cycle shift.

### FM OPERATION

FM Operation is accomplished by Reactance Tube V4 (12BY7) modulating the 60 Kcs Carrier Oscillator. In the FM position, the audio amplifier output is fed to the screen grid of the Reactance tube thereby translating audio variations to frequency deviations of the Carrier Oscillator.

Tune up the transmitter as outlined in the preceding general and CW sections. Turn Operation Switch to Calibrate. Zero beat the transmitted signal in the communications receiver. Rotate the Function Switch to indicate FM and adjust the small "FM-FSK $\Delta$ F" knob for zero beat if necessary. Turn Operations Switch to MOX and raise Audio Level until a small fluctuation of the Output Level is observed on the meter.

### BIAS CONTROL ADJUSTMENT

The output of the bias supply in the transmitter

has been set at the factory to -50 volts d.c. with 117 volts a.c. power line input. If the line voltage is subject to variations, it is advisable to monitor the plate current of the 6146 vacuum tubes and make periodic adjustments in the bias voltage to keep the plate current at its optimum value. Adjustments of the bias supply will result in extending the life of the vacuum tubes and will provide maximum output power.

Provision has been made via the "External Connection" plug to connect a 0-300 milliamperere d.c. or a 0-3 volt d.c. voltmeter to read cathode current on the Final Amplifier tubes. The 0-3 volts d.c. meter will read 0-300 milliamperes when connected. Connect the positive meter terminal to pin 14 of the plug and the other side of the meter to pin 13 of the plug.

Rotate the "Bias Adj." to read 60 milliamperes of plate current when the equipment is in the standby, LSB or USB positions.

### MODEL HX-500 USED AS AN EXCITER-DRIVER WITH A LINEAR AMPLIFIER

The model HX-500 output power is more than adequate for driving a high powered linear amplifier. It may be necessary to insert a resistive pad to absorb some of the power output and for the purpose of maintaining a 50 Ohm load to the HX-500 Transmitter. The amount of padding needed will depend upon the circuitry in the linear amplifier and the tubes used. Always use the least padding necessary so that the HX-500 is working at well below its maximum output. This will result in more linear operation overall and extend the 6146 tube life.

When the HX-500 is used as an Exciter-Driver, the RF Level Control is adjusted for optimum drive on the grid of the high powered linear amplifier instead of the 6146's.

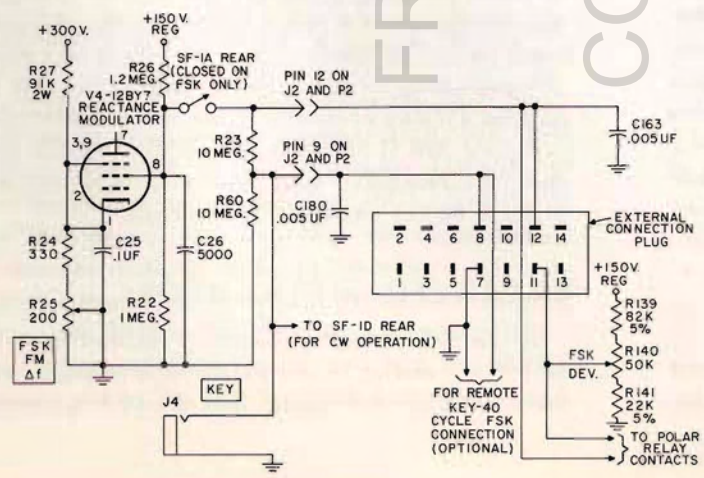

**Figure 3.**  
**Simplified Schematic Diagram**  
**showing RTTY Operation**



## HAMMARLUND HX-500 TRANSMITTER CIRCUIT DESCRIPTION

### AUDIO AMPLIFIER;

Signals from the microphone enter through the front panel microphone connector. These small audio variations are then amplified by means of a three stage resistance coupled amplifier, consisting of both sections of a 12AX7 (V-5A-B), and one half of a 6CM7 (V-6A). The amplifier is limited in response below 300 cps by means of appropriate values of coupling condensers. This helps to improve the unwanted sideband rejection in the sideband filter, and in addition serves to prevent distortion due to overloading of the transmitter by high energy, low frequency peaks.

Since all modulation in the HX-500 is accomplished at low power levels, the audio amplifier is not required to supply any appreciable amount of power to the load, and is consequently designed as a voltage amplifier only. The main audio output is directed to the balanced modulator for AM (DSB) and SSB (LSB-USB) operation, or to the reactance tube modulator for FM operation. The audio amplifier is out of the circuit on CW and FSK positions. Part of the audio output is routed to the voice operated relay (VOX) circuits to be described later.

### 60 KCS OSCILLATOR:

A 6AU6 pentode tube (V-1), is employed as an electron-coupled Hartley oscillator operating at a frequency of 60 kcs. This low frequency allows the use of a high C/L ratio tank, thus providing a high degree of stability usually obtained only in a crystal oscillator. At the same time, it permits the oscillator frequency to be varied (modulated) for FM and FSK signals, by means of a reactance tube modulator connected in parallel with the oscillator tank circuit. Another advantage in the use of this low frequency is the excellent rejection of the unwanted sideband in the SSB filter. Temperature stability is enhanced through the use of a special ferrite tuning core.

The output of the 60 kcs oscillator feeds the balanced modulator and provides the fundamental carrier energy in all modes of transmission.

### REACTANCE TUBE MODULATOR:

In this circuit a 12BY7 pentode (V-4), is employed as a reactance tube modulator. On FM and FSK po-

sitions the plate circuit of this tube is connected in parallel with the 60 kcs oscillator tank circuit, and acts as a shunt inductance, and would raise the resonant frequency were it not for Capacitor C-110 which compensates for this added inductance, and maintains the 60 kcs oscillator at its center frequency under no signal conditions. R-25, in the cathode circuit of the reactance tube provides compensating adjustment for tube aging and component tolerances.

In the FM mode of operation, the output of the audio amplifier is applied to the screen of the reactance tube, varying the transconductance, and thereby the effective inductance across the oscillator tank circuit. This causes the frequency of the 60 kcs oscillator to shift by an amount proportional to the audio modulating voltage. Circuit parameters limit the resultant frequency deviation to a maximum of about 3 kcs.

On FSK position, the FSK DEV. control, R-140, is placed in shunt with the high impedance screen circuit, thus clamping the screen voltage by an amount determined by the setting of R-140. Depending on the voltage available from R-140, this may either increase or decrease the tube transconductance, with a resultant shift in the 60 kcs oscillator frequency. R-140 may be adjusted to provide for varying amounts of deviation up to a maximum of approximately 2 kcs, the standard for RTTY being 850 cps. The switching of R-140 across the screen circuit is controlled by the output contacts of the teletype transmitter, in association with a polar relay. Terminals for connecting this relay are brought out to pins #11 and #12 on the external connector J-11, located on the rear apron of the transmitter chassis. Forty cycle (40 cps) identification frequency shift is obtained on FSK position by means of a small change in screen voltage as a result of the closing of the telegraph key. This small shift in frequency will provide adequate code identification as required by the FCC without causing operation of the receiver teleprinter.

During SSB (LSB-USB), AM (DSB), and CW operation, the reactance tube modulator is disconnected from the 60 kcs oscillator tank circuit.

### BALANCED MODULATOR:

In the SSB mode, the output of the audio amplifier is fed in parallel to the balanced modulator. At the same time, the R-F signal from the 60 kcs oscillator



is applied in push-pull. The resultant heterodyne action will produce sidebands above and below the carrier center frequency (60 kcs) by an amount equal to the modulating frequency. As the R-F inputs to the balanced modulator are 180 degrees out of phase and the output is effectively in parallel, the 60 kcs carrier will be cancelled. The sideband products remain however, and are passed on to the 60 kcs filter for rejection of the unwanted sideband. Either the upper or lower sideband may be selected by means of the front panel function switch. CR-1 and CR-2, the 1N634 crystal diodes, are employed as modulator elements because of their good linearity and high front to back conduction ratio. Transformer T-1 which couples the R-F signal from the 60 kcs oscillator is bifilar wound to secure the necessary balanced feed to the diode modulators. On AM (DSB) position, the balanced modulator is unbalanced by disconnecting one of the 1N634 diodes, thus producing a conventional AM signal with carrier.

#### **60 KCS AMPLIFIER AND SIDE BAND FILTER:**

The low 60 kcs oscillator frequency permits the use of a highly efficient and unique tuned circuit for removal of the unwanted sideband, and for properly shaping the high side of the desired sideband. The first group of filters consist of L-3, L-4, and L-5, working into a 6EW6 pentode tube (V-2), the output of which is connected to the second filter group comprised of L-6, L-7, L-8 and L-9. The amplification obtained serves to compensate for the insertion loss the two filter sections, while the amplifier circuitry provides isolation required for optimum operation.

Top capacity coupling is utilized within each group of tuned circuits. A combination of overcoupled and undercoupled conditions are used to provide an adequate bandpass and still retain the steep sided response curve necessary for sideband operation. A bifilar "T" trap rejection filter consisting of T-2 and Z-1 is used to improve the sharp cut-off characteristics of the filter chain. The "T" rejection filter is adjusted for maximum rejection of the unwanted sideband at 250 cycles from the carrier frequency.

It should be noted that the front panel function switch knob indicates the lower sideband position when the sideband filter is actually passing the upper sideband of the 60 Kc oscillator. This is due to the fact that unlike the first and second mixer whose heterodyne oscillators operate on the low side of the signal frequency, the third mixers heterodyne oscillator operates on the high side of the signal fre-

quency. This effectively inverts the sideband position with respect to the carrier, due to the subtractive action of this type of mixer. The final output from the transmitter agrees with the knob indication, but up to the third mixer it should be remembered the sidebands are reversed.

The sideband filter is aligned in the upper sideband position (front panel knob indicates LSB). When the function switch knob on the front panel indicates USB (final transmission mode on the switch) the sideband filter is actually operating on the lower sideband and a small amount of closely controlled fixed capacity is added to each band pass tuned circuit, lowering the resonant frequency. This symmetrically locates the passband below the carrier frequency instead of above.

When operating CW, FM, FSK or AM (DSB), the signal bypasses the 60 kcs amplifier and sideband filter and passes directly to the first mixer.

#### **FIRST MIXER & 1590 KCS OSCILLATOR:**

The signal from the balanced modulator is routed either directly to the grid of the first mixer (CW-FM-FSK-DSB), or through the 60 kcs amplifier and filter (LSB-USB), and beats with the signal from the first of three heterodyne oscillators which ultimately produce the final operating frequency. The heterodyne frequencies are carefully selected to keep spurious outputs to an exceptionally low minimum value.

In this stage, a 6U8 dual purpose pentode and triode combines the function of both mixer and oscillator. The pentode section, V-3A, acts as the mixer, while the triode section, V-3B, is employed in a crystal controlled oscillator circuit operating at a frequency of 1590 kcs. The resultant beat note between the 60 kcs mixer and the 1590 kcs signal from the oscillator is applied to the input of a 1650 kcs filter which provides further shaping of the signal passband characteristics.

The plate voltage of the oscillator section is supplied by a regulated 150 volts to insure absolute stability. A special 1590 kcs trap is employed as part of the output filter, thereby preventing any possibility of the oscillator signal being passed on to subsequent stages. Two sections of the 1650 kcs filter are located on the exciter chassis and are joined to the third section on the VFO chassis by means of a low capacity, shielded, polyethylene cable connected from J-1 to J-6. The output of the 1650 kcs filter is then routed to the grid of the second mixer.



## SECOND MIXER & VARIABLE FREQUENCY OSCILLATOR:

Following the 1650 kcs filter, the signal is fed to the grid of the pentode section of a 6U8, V-9A, where it beats with the signal from the variable frequency oscillator (V.F.O.) comprised of the triode section of the same tube, V-9B, tunable over the range of 3.9 MC to 4.4 MC. The second mixer and V.F.O. are constructed on a separate sub-chassis to provide the utmost in mechanical isolation. The V.F.O. employs a ceramic coil form and a high stability tuning capacitor. This circuit is also temperature compensated to minimize warm-up drift.

The oscillator circuit proper, is a high C/L ratio modified Colpitts which further improves the excellent frequency stability characteristics. The variable tuning capacitor, C-91, is directly gear driven from the FREQUENCY control knob on the front panel to eliminate backlash, and provide for a high order of calibration accuracy and re-setability.

The output heterodyne frequency of the second mixer may be anywhere in the range of 5.55 MC to 6.05 MC, depending on the setting of the V.F.O. tuning capacitor. This signal is then applied to three filter sections tuned to this range, the first two being located on the V.F.O. sub-chassis, link coupled to the third section located on the main chassis, by means of a low capacity, polyethylene cable connected between J-7 and J-9. From the center tap of the bi-filar transformer in the first filter section there are two wave traps connected to ground. These traps are tuned to 5.5 MC and 6.15 MC and effectively eliminate the possibility of any spurious radiation at or close to these frequencies.

Connector J-8 on the V.F.O. sub-chassis mates with the cable plug P-8 from the main chassis, supplying filament voltage as well as 150 volts (regulated) and 300 volts (non-regulated) for the oscillator and mixer sections respectively.

## BROADBAND (BAND PASS) AMPLIFIER:

The signal at this point in the circuit may be anywhere in the frequency range of 5.55 MC to 6.05 MC, requiring broadband circuitry for further amplification.

Two 6CB6 sharp cut-off pentodes, V-10 and V-11, are employed for reasons of excellent linearity and wide frequency handling capabilities. These tubes are normally biased at a high negative voltage (50 volts) so that in the receive or standby modes the signal does not pass beyond this stage. Closing the telegraph key, or operation of the VOX relay during

voice transmission, removes this negative bias and permits the signal to be passed by the amplifier.

The grids of the broadband amplifier tubes are connected to the automatic level control circuit (ALC) which functions in much the same manner as receiver AGC. This is more fully explained in the section devoted to this circuit.

The R-F LEVEL control, R-57, is inserted as a bias control in the transmit mode, and allows the gain of the 6CB6 broadband amplifier tubes to be varied according to output requirements.

## THIRD MIXER & FINAL HETERODYNE OSCILLATOR:

After amplification in the broadband amplifier, the signal is coupled by means of capacitor C-110 to the grid of the third mixer. At this point, the signal (5.55 MC - 6.05 MC) is heterodyned with the output of the last (crystal controlled) oscillator to produce the final output frequency ranging from 3.5 MC to 30 MC, depending on the position of the BAND SELECTOR switch, SB-3. As mentioned previously, the sidebands are reversed with respect to the front panel knob indication up to the third mixer. Due to the subtractive action of this type of mixer-oscillator it is here that the sidebands are reversed to agree with the front panel knob indication.

Separate oscillator and mixer tubes are employed in this stage, providing a high degree of electrical isolation and frequency stability. A 6EW6 pentode, V-12, is used as the mixer tube, while a 6C4 triode, V-13, is employed in the crystal controlled oscillator section.

The proper crystal and tuned circuit for the oscillator are selected by the BAND SELECTOR switch. All eight crystals required for complete coverage of the ham bands, including the entire 10 meter band, are provided as part of the transmitter. The tuned circuits for the output of the mixer are also selected by means of the BAND SELECTOR switch, and couple the signal to the grid of the driver stage for further amplification.

When not transmitting, the 6EW6 third mixer, V-12, is also biased at minus 50 volts along with the broadband amplifier tubes, providing additional insurance against radiation of energy.

## DRIVER AMPLIFIER:

The driver stage employs the high gain video type pentode, 12BY7 (V-14), to obtain sufficient linear R-F energy to drive the final output stage. As the final tubes are operated class AB-1 there is no grid



current drain in that stage under normal signal conditions, and the driver is not required to supply any power, being designed and operated as a high gain voltage amplifier only.

The proper tuning networks for the plate circuit of the driver are selected by appropriate sections of the BAND SELECTOR switch, SB-3. The outputs of these tuning networks feed the signal from the driver to the grids of the final 6146 amplifier tubes by means of capacitor C-136.

Fine tuning of the driver stage is accomplished in both the grid and plate circuits by means of variable capacitor C-133, the DRIVER TUNE control.

### FINAL (POWER) AMPLIFIERS:

The final amplifier employs a pair of 6146 pentode tubes, V-16, connected in parallel. They provide a nominal power output of 100 watts (PEP) on either upper or lower sideband and 100 watts on CW, FM, and FSK, with maximum linearity and minimum distortion. The power output on AM (DSB) is 25 watts.

The amplifier is neutralized by means of capacitor C-149 on the highest portion of the 10 meter band and maintains its performance over the entire range of frequencies transmitted.

R-F choke L-34, in the grid circuit provides the proper input impedance as well as serving as a grid return for the bias supply. Chokes L-27 and L-28, together with parallel resistors R-120 and R-121, act as low "Q" parasitic suppressors. Resistors R-119 and R-122 in the screen circuits also provide isolation from possible parasitic oscillations.

A final tuning capacitor, C-150, controlled from the front panel, provides a means of resonating the plate circuit. RFC L-29 serves to prevent R-F from returning to ground through the power supply.

The output of the parallel 6146's feeds a pi network comprised of L-31 and appropriate values of capacity. Coil L-30 in the plate circuit has taps which are selected by means of the BAND SELECTOR switch, providing optimum load impedance at all times. The output impedance is fixed at 50 ohms, thus eliminating mismatch when used with standard 50 ohm antenna systems. If antenna impedances other than 50 ohms are encountered, a simple external antenna coupler may be used to provide the proper match.

As an added operating convenience, the HX-500 contains an internal antenna change-over relay with connections for the receiver input by means of external connector J-14, located on the rear chassis apron.

### AUTOMATIC LEVEL CONTROL (ALC)

Part of the output of the final amplifier is coupled to the automatic level control (ALC) circuit by means of capacitor C-170. This signal is then rectified by one of the 6AL5 diode sections, V-17B, providing a bias control voltage which is applied to the grids of the two 6CB6 broadband amplifier tubes. The net result is to limit the output of the broadband amplifier so as to prevent overdriving of the subsequent stages (particularly the final) thus effectively eliminating the possibility of overload and resultant frequency splatter.

Potentiometer R-124, acts as a voltage divider across the ALC rectifier tube, allowing the threshold level to be varied according to operating requirements. This has the effect of delaying the action of the ALC rectifier until a relatively high level of output from the final amplifier is reached. In this manner, the transmitter is able to operate with normal gain characteristics under average signal conditions. When the predetermined output signal is exceeded, the automatic level control circuit will then respond very rapidly to keep the output to a safe value.

### VOICE OPERATED RELAY (VOX)

Part of the output from the second audio amplifier is fed through capacitor C-49, to the VOX SENSITIVITY control, R-43, in the grid circuit of V-6B. This half of the 6CM7 dual triode tube is employed as the VOX amplifier, serving to increase the audio level for proper operation of the VOX diode rectifier, V-7A. This circuit contains the VOX DELAY control, R-48 which determines the amount of delay time in the operation of the VOX relay, K-1, and antenna change-over relay, K-2.

The triode section of the 6U8 tube, V-8B, is used as the anti-trip relay tube, while the pentode section, V-8A, serves as the anti-trip amplifier. Potentiometer R-53 in the grid circuit of the pentode section serves as the ANTI-TRIP SENSITIVITY control, providing a means of adjusting the input level, relative to the audio output from the station receiver. The output signal of the anti-trip amplifier is then rectified by V-7B, the anti-trip diode.

This rectified voltage is then applied as a back-bias to the plate of the VOX diode, V-7A preventing the voltage developed by the microphone amplifier from causing relay K-1 to be energized. With proper adjustment of both the VOX SENSITIVITY and the ANTI-TRIP controls, a condition of balance will be attained which will provide correct VOX operation, yet prevent the relay from being actuated by sound from the station receiver's speaker.



## OUTPUT METER CIRCUIT

The output meter provides a means of measuring the relative output of the transmitter in all modes of transmission. The scale is semi-logarithmically calibrated from 0 to -60 db.

CR-3, a IN34A crystal diode, and CR-4, a special HD6164 silicon diode are employed in the metering circuit, performing in such a manner as to cause the output meter scale calibration to agree with the output level from the final amplifier. CR-3 establishes the basic reference voltage for operation of the meter, while the characteristics of CR-4 do not allow it to conduct any appreciable amount until A pre-determined voltage output from CR-3 is reached. At this point (about 0.6V or higher) the silicon diode, CR-4 will conduct heavily, effectively swamping the meter circuit and slowing the otherwise fast rise of the meter movement and pointer. This allows the meter to give a truer indication of relative output as indicated by the meter scale calibrations. Rheostat R-59 the METER SENSITIVITY control, is adjustable from the front panel, and provides a means of varying the meter indication according to specific requirements.

## POWER SUPPLY

The power supply is located on the main chassis of the HX-500, and is generously rated to provide all the power requirements of the transmitter.

A heavy duty power transformer supplies approxi-

mately 900V rms for each 12AX46T high voltage rectifier tube plate, and 320V rms for each plate section of the 6CA4, the low voltage rectifier tube. In addition, there are separate windings which supply 12.6V at 1.2 amps for the 12AX46T rectifier filaments, and 6.3V at 10 amps for the 6CA4 low voltage rectifier filaments as well as the filaments of the tubes in the transmitter proper. The 6.3V winding also powers the #47 pilot lights DS1, 2, 3 and 4.

One section of a 6AL5, V-17A, acts as the bias rectifier whose output is controlled by a voltage divider network consisting of R-134, R-135, and the BIAS ADJUST rheostat R-136.

An OA2 voltage regulator tube, V-21, operates off a voltage divider network from the 215V tap on the low voltage rectifier circuit. This tap provides the voltage for operation of the V-R tube, which provides a regulated 150V d.c. output.

Additional high voltage d.c. outputs are provided by the H.V. rectifier (780V), and by the L.V. rectifier (215V. + 300V. + 350V.) for the operation of the various transmitter stages.

Two bias voltages of -50V and -100V are supplied by the bias rectifier.

All rectifier circuits are well filtered, insuring low hum and distortion levels.

A blower motor and fan, for cooling of the output tubes plugs into a receptacle on the power supply chassis and is controlled by the main power switch in the power transformer primary.

## TUBE COMPLEMENT

Symbol	Type	Tube	Function
V1	6AU6	Pentode	60 Kcs Oscillator
V2	6EW6	Pentode	60 Kcs Amplifier
V3	6U8	Triode-Pentode	Crystal Oscillator - 1st Mixer
V4	12BY7	Pentode	Reactance Modulator
V5	12AX7	Double Triode	1st and 2nd Audio Amplifier
V6	6CM7	Double Triode	3rd Audio Amplifier - VOX Amplifier
V7	6AL5	Double Diode	VOX Diode - Anti-Trip Diode
V8	6U8	Triode-Pentode	Anti-Trip Amplifier - Relay Amplifier
V9	6U8	Triode-Pentode	VFO - 2nd Mixer
V10	6CB6	Pentode	Bandpass Amplifier
V11	6CB6	Pentode	Bandpass Amplifier
V12	6EW6	Pentode	3rd Mixer
V13	6C4	Triods	H.F. Crystal Oscillator
V14	12BY7	Pentode	R.F. Amplifier - Driver
V15	6146	Pentode	Final R.F. Power Amplifier
V16	6146	Pentode	Final R.F. Power Amplifier
V17	6AL5	Double Diode	ALC - Bias Rectifier
V18	12AX4	Diode	High Voltage Rectifier
V19	12AX4	Diode	High Voltage Rectifier
V20	6CA4/EZ81	Double Diode	Low Voltage Rectifier
V21	OA2	Gas-Filled Diode	Voltage Rectifier

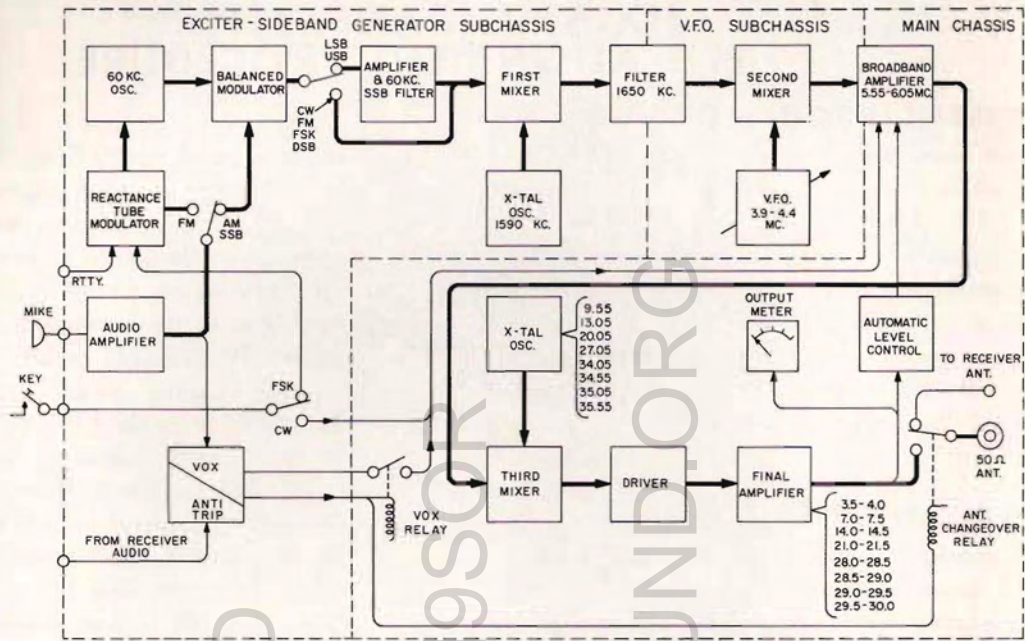

Figure 4. Simplified Block Diagram

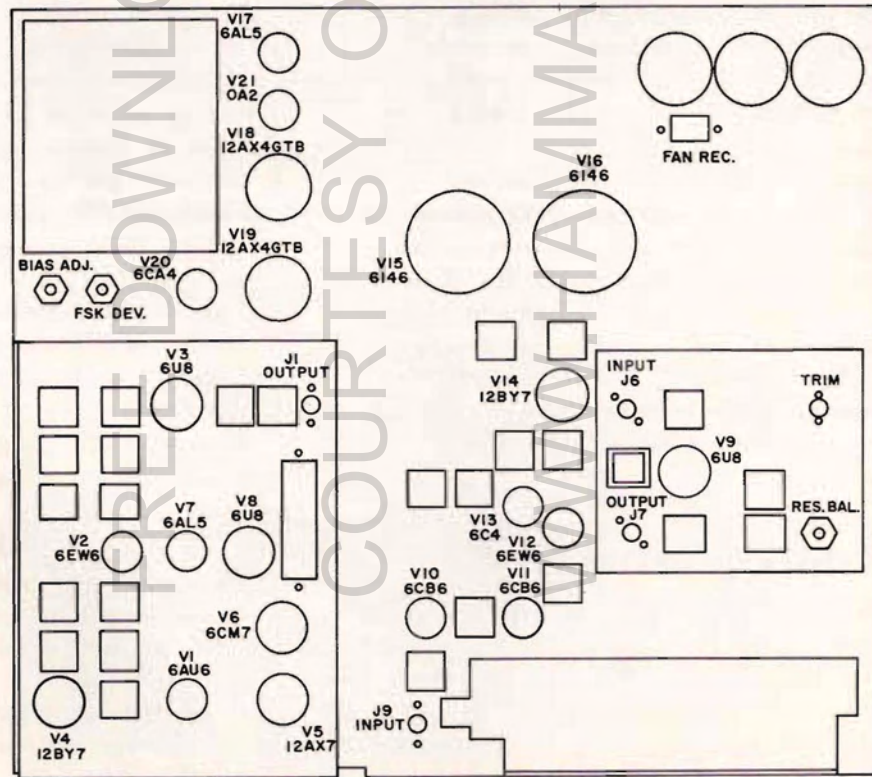

Figure 5. Tube Location Diagram





## HX-500 TRANSMITTER FIELD ALIGNMENT PROCEDURE

### EQUIPMENT REQUIRED:

1. General coverage receiver covering 600 KCS to 30.5 MCS.
2. 100 KCS crystal calibrator.
3. Audio generator - 1% accuracy.
4. R-F Generator - 1% accuracy.
5. VTVM or Wattmeter. (optional)
6. 50 ohm dummy load or two 60 watt bulbs in parallel. (optional)
7. 0-300 MA Milliammeter (optional)

### GENERAL INSTRUCTIONS:

The alignment procedure to be described is a much simplified version of the one performed at the factory. It will enable the operator in the field to realign the HX-500 transmitter with reasonably good accuracy with a minimum amount of test equipment. This procedure, together with voltage and resistance charts contained in this manual will usually provide the information necessary to restore the transmitter to peak operating efficiency. If more serious trouble exists than might normally be encountered the unit should be returned to the factory or to the nearest field maintenance station.

If the necessary high quality test equipment is available the "Comprehensive Alignment Procedure" may be followed and will provide more precise and accurate adjustments. In no case should the "Comprehensive Alignment Procedure" be followed without the equivalent test equipment of known accuracy. When using the following "Field Alignment Procedure" no attempt should be made to align or adjust circuits or components not specifically covered in the instructions.

### INITIAL CONTROL SETTINGS:

1. "Function" switch on "LSB"
2. "Operations" switch on "CAL"
3. "Meter Sensitivity" maximum CW
4. "Calibrate Level" maximum CW
5. "R-F Level" as required

### ALIGNMENT PROCEDURE:

1. Connect the 60 KCS oscillator output developed across R8 (balanced modulator circuit) through a

.01 or larger capacitor to the antenna input of a receiver tuned to 600 KCS. The receiver should be accurately set on frequency with a 100 KCS crystal calibrator that has been checked against a known standard such as station WWV.

2. Carefully adjust the 60 KCS oscillator, L1, for zero beat in the receiver (10th harmonic). The same BFO and dial setting employed with the crystal calibrator should be used.
3. Feed a 1300 cycle  $\pm 10$  cycle signal of 1 volt to the "Patch" input on the transmitter front panel. Rotate "Audio Level" control to "7". Tune up transmitter at 3.75 MCS (80 M) adjusting the "R-F Level" control so the transmitter level indicator meter M1 reads about -10 DB. Connect a 10K  $\frac{1}{2}$  watt resistor across C13 and another across L7. Adjust "R-F Level" control if necessary. Peak L6 for maximum making sure the adjustment is very precise. Remove the 10K resistors from across C13 and L7 and connect them across L6 and L8. Peak L7 and L9 for maximum on the "Level Indicator M1". Remove resistors from across L6 and L8 and connect them across L7 and L9. Peak L8 for maximum and then remove the resistors.
4. Set audio generator to 1250 cycles  $\pm 10$  cycles. Connect a 10K resistor across L4 and peak L3 and L5 for maximum. Remove resistor from L4 and connect it across L5. Peak L4 for maximum.
5. Tune audio generator between 300 and 2300 cycles and locate the frequency of maximum output, keeping the "Level Indicator" at about -10 DB with the "R-F Level" control. At the frequency of maximum output use the "R-F Level" control to set the "Level Indicator" to exactly -10 DB.

### Note:

The audio generator should maintain constant output at least over the range of 250 to 2500 cycles.

Tune audio generator lower in frequency until the "Level Indicator" reads -16 DB. This should be between 260 and 340 cycles. Tune audio generator higher in frequency very slowly noting that the "Level Indicator" does not drop -14 DB until between 2200 and 2400 cycles the "Level Indicator" reads -16 DB.

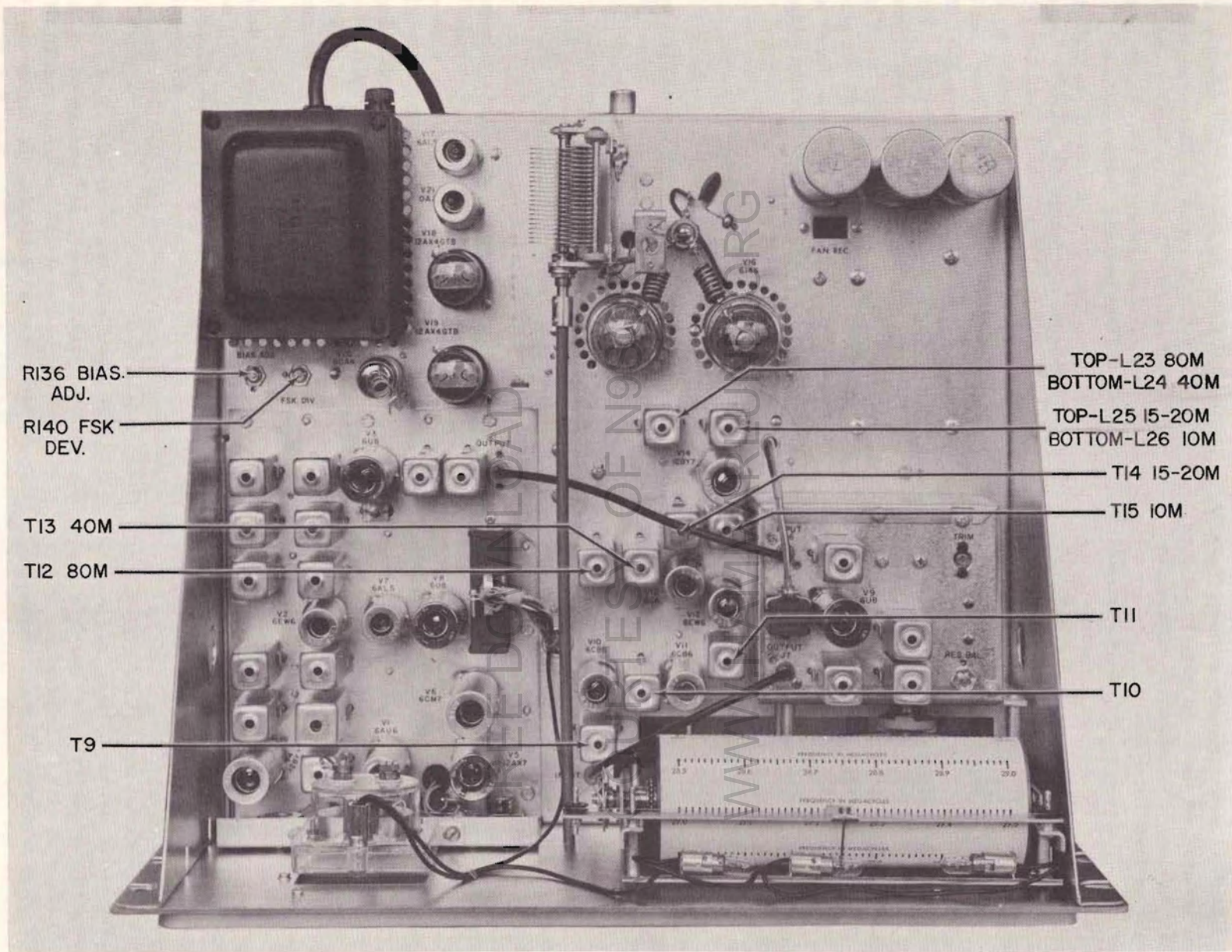

Figure 6. Top View of the HX-500 Transmitter Chassis (H.V. Cover Removed)





6. Rotate "Function" switch to USB. Do not disturb HX-500 or audio generator settings. Tune audio generator for maximum response on the "Level Indicator". This should be no more than -13 DB on the "Level Indicator". Adjust the "R-F Level" control so that the meter reads -10 DB. The -16 DB frequencies should be the same as for the "LSB" position.
7. Disconnect cable from J6 and feed the output of the "Exciter" section into the antenna input of the receiver. Be sure that the "Function" switch is on either LSB or USB and that the "Audio Level" control is adjusted maximum CCW. Tune in the 1590 KCS signal for maximum on the receiver level indicator and adjust the top slug of T3 for Minimum on receiver level indicator.
8. Reconnect cable to J6 and tune up transmitter in the 80 meter band. With the transmitter "Level Indicator" adjusted by means of the "R-F Level" control to approximately -20 DB or less, adjust the bottom slug of T3 and top and bottom slugs of T4 and T6 for maximum output on the transmitter "Level Indicator". Be sure to keep output below -10 DB on the meter by means of the "R-F Level" control.
9. Tune transmitter to 4 MCS. Set the "Frequency KCS" dial to zero with the scale pointer resting at exactly 4 MCS. Tune up transmitter and feed signal into the receiver (previously calibrated with the 100 KCS calibrator). The receiver should be tuned to exactly 4 MCS. Adjust L17 for zero beat. Tune receiver to 3.5 MCS with the calibrator. Tune transmitter to 3.5 MCS making sure that the "Frequency KCS" dial is on zero when the dial scale pointer is on or close to 3.5 MCS. Adjust C92 for zero beat in the receiver. Repeat 9. until no adjustment is necessary for zero beat at 3.5 and 4 mcs.
10. Tune transmitter to 3.75 MCS making sure of frequency accuracy by first zero beating 3.8 MCS with the receiver calibrator with the "Frequency KCS" dial on zero. Place a 1K ½ watt resistor having as short leads as possible across secondary of T11. Very carefully tune the bottom slug of T11 for maximum on the x'mitter level indicator. Remove resistor from secondary of T11 and connect across primary. Peak top slug of T11 for maximum. Repeat above procedure for T10.
11. Tune up transmitter at 3.775 MCS and place 1K resistor across primary of T9. Adjust top slug of T9 and bottom slug of T8 for maximum on "Level Indicator". Remove resistor and connect across secondary of T9. Adjust bottom slug of T9 for maximum. Remove resistor.
12. Be sure "Function" switch is on LSB and "Operations" switch is on "CAL". Connect signal generator to junction of SB-3C and C124 (grid of V14). Set "Band Selector" to 10M (28.0 - 28.5 MCS). With "Driver Tune" set for maximum capacity (CCW) feed in a 27.75 MCS signal and adjust generator level and "Final Tune" so that the "Level Indicator" M1 reads less than -20 DB. Peak bottom slug (insert tool from top) of L26 for maximum on M1. Set generator to 30.25 MCS. Rotate "Driver Tune" and "Final Tune" to minimum capacity. Adjust C143 for maximum output.
13. Remove V13 from its socket. Connect signal generator to pin #1 of V12. Run top slug of T15 to top of can. Rotate "Driver Tune" to maximum capacity. With a 27.75 MCS signal into V12 rotate "Final Tune" for maximum on M1. Adjust signal generator output to keep indication below -10 DB. Peak bottom slugs of L26 and T15 for maximum on M1, readjusting signal generator level if necessary.
14. Set signal generator to 30.25 MCS. Rotate "Driver Tune" to minimum capacity and "Final Tune" for maximum indication on M1. Peak C143 and C132 for maximum on M1 keeping reading below -10 DB by means of signal input level.
15. Set signal generator to 29 MCS. Peak "Driver Tune" and "Final Tune" for maximum on M1. Adjust top slug of T15 for maximum on M1. If a dummy load is available, the output may be checked by rotating "Operations" switch to "MOX" and increasing generator input level until output indicator (wattmeter or VTVM) reads

#### NOTE:

If oscillation occurs when adjustments are made check to see if C149 (neutralizing capacitor) is set at about half capacity. Repeat above step if necessary. If neutralization is required refer to instructions under "Neutralization Procedure" Step 25.

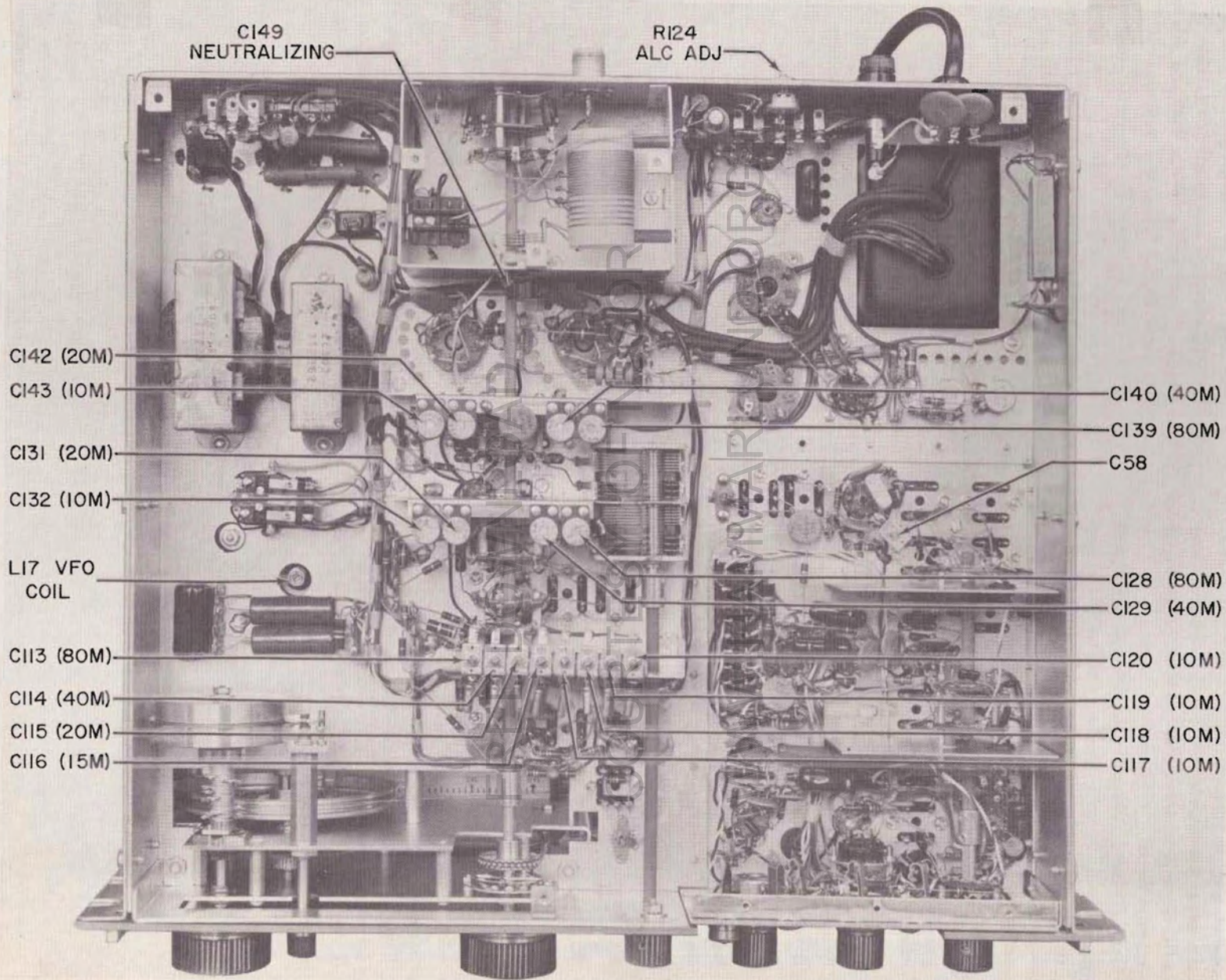

Figure 7. Bottom View of the HX-500 Transmitter Chassis (Covers Removed)





either 70 watts or 60 volts respectively. The output may be substantially higher but this is the usual minimum value. Final cathode current will be approximately 250 MA as received on external meter.

16. Rotate "Band Selector" to 15M and set signal generator to 20 MCS. Run top slug of T14 to top of can. Rotate "Driver Tune" to *maximum* capacity and "Final Tune" for maximum indication on M1. Adjust top slug of L25 and bottom slug of T14 for maximum on M1.
17. Rotate "Band Selector" to 20M and set signal generator to 14.6 MCS. Set "Driver Tune" for *minimum* capacity and "Final Tune" for maximum indication on M1. Adjust C142 and C131 for maximum on M1 keeping level below -10 DB. Repeat steps 16 and 17.
18. Rotate "Band Selector" to 15M and set signal generator to 21.25 MCS. Adjust "Driver Tune" and "Final Tune" for maximum on M1. Peak top slug of T14 for maximum on M1. The output may be checked at this frequency by following the procedure outlined in step 15. Be sure to return "Operations" switch to "CAL" position afterwards.
19. Rotate "Band Selector" to 40M and set signal generator to 6.95 MCS. Run top slug of T13 to top of can. Rotate "Driver Tune" to *maximum* capacity and "Final Tune" for maximum output on M1 level indicator. Adjust bottom slugs of L24 and T13 for maximum indication on M1.
20. Set signal generator to 7.5 MCS. Rotate "Driver Tune" to *minimum* capacity and "Final Tune" for maximum indication on M1. Adjust C140 and C129 for maximum on M1. Repeat steps 19 and 20 if necessary.
21. Set signal generator to 7.15 MCS. Peak "Driver Tune" and "Final Tune" for maximum on M1.

Adjust top slug of T13 for maximum indication. The output may be checked at this frequency by following the procedure outlined in step 15.

22. Rotate "Band Selector" to 80M and set signal generator to 3.3 MCS. Run top slug of T12 to top of can. Rotate "Driver Tune" to *maximum* capacity and "Final Tune" for maximum indication on M1. Adjust top slug of L23 and bottom slug of T12 for maximum on M1 level indicator.
23. Set signal generator to 4.15 MCS. Rotate "Driver Tune" to *minimum* capacity and "Final Tune" for maximum on M1. Adjust C139 and C128 for maximum indication on M1 level indicator. Repeat steps 22 and 23 if necessary.
24. Set signal generator to 3.75 MCS. Peak "Driver Tune" and "Final Tune" for maximum on M1. Adjust top slug of T12 for maximum on M1. The output may be checked at this frequency by following the procedure outlined in step 15.
25. NEUTRALIZATION PROCEDURE: Remove the H.V. rectifiers tubes V18 and V19 (12AX4GTB's) from their sockets. Disconnect the +215 volt lead from the junction of R137 and R138. Turn on power and feed a 29 MCS signal of about 2 volts to pin #2 of V14. Be sure that "Operations" switch is on "MOX" position and not "CAL". Connect a VTVM set to a scale no higher than 3 volts to the junction of C148 and L30. Rotate "Driver Tune" and "Final Tune" for maximum indication on the VTVM. Adjust the neutralizing capacitor C149 for minimum indication on the VTVM. Repeat above until the reading on the VTVM is less than 0.1 volt. Disconnect and turn off the power. Replace V18 and V19 and reconnect the +215 volt lead to the junction of R137 and R138. Be sure to replace cover to final tank compartment if removed for neutralization check.

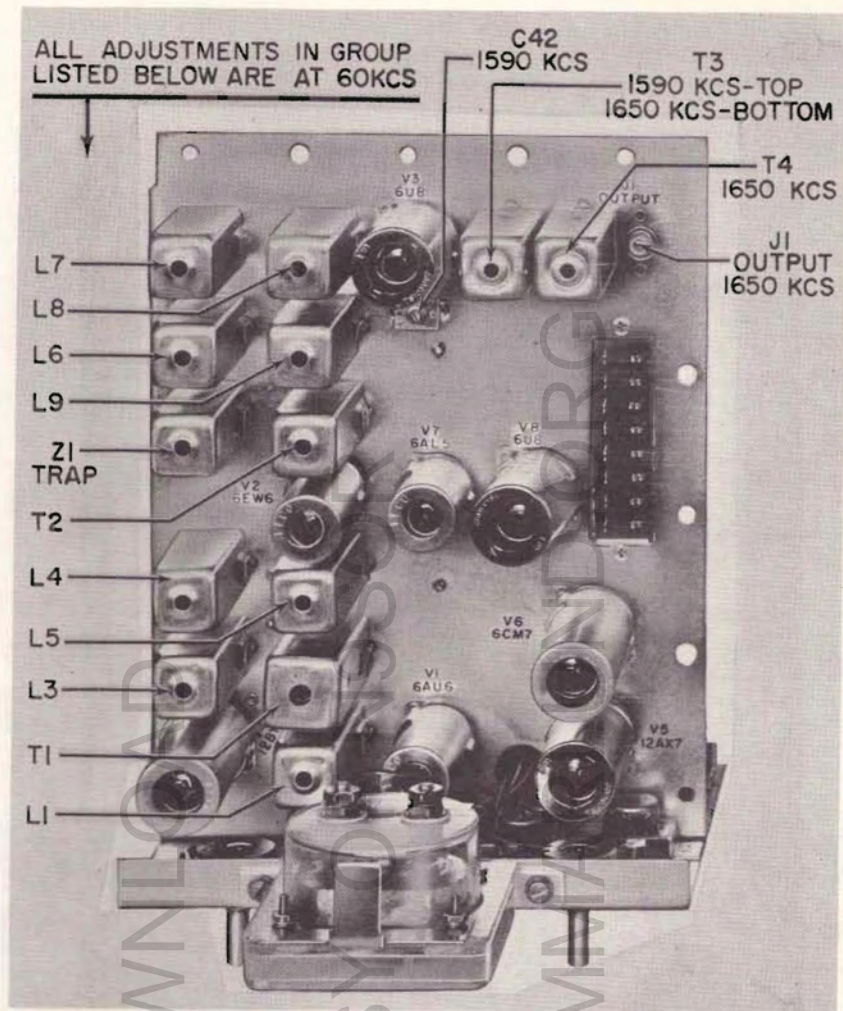

Figure 8. Top View of Exciter Assembly Subchassis

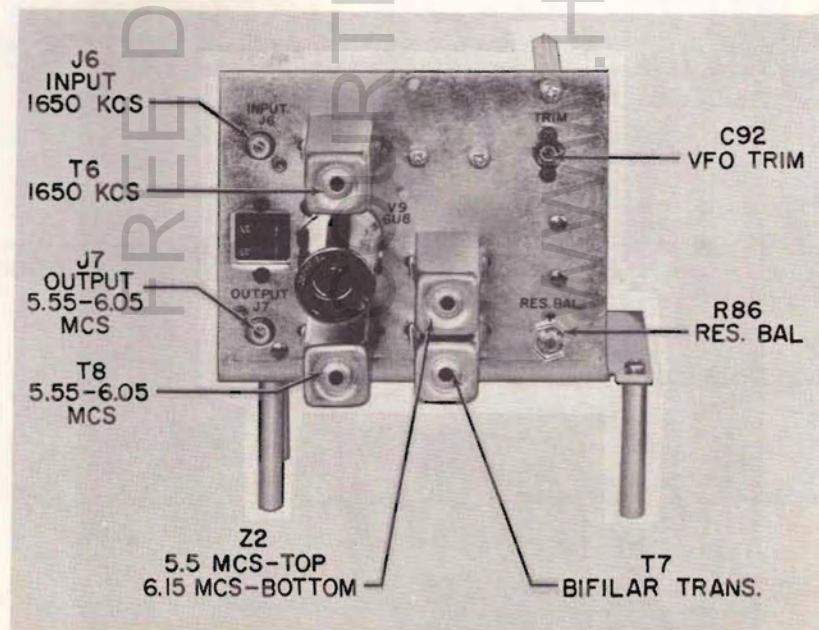
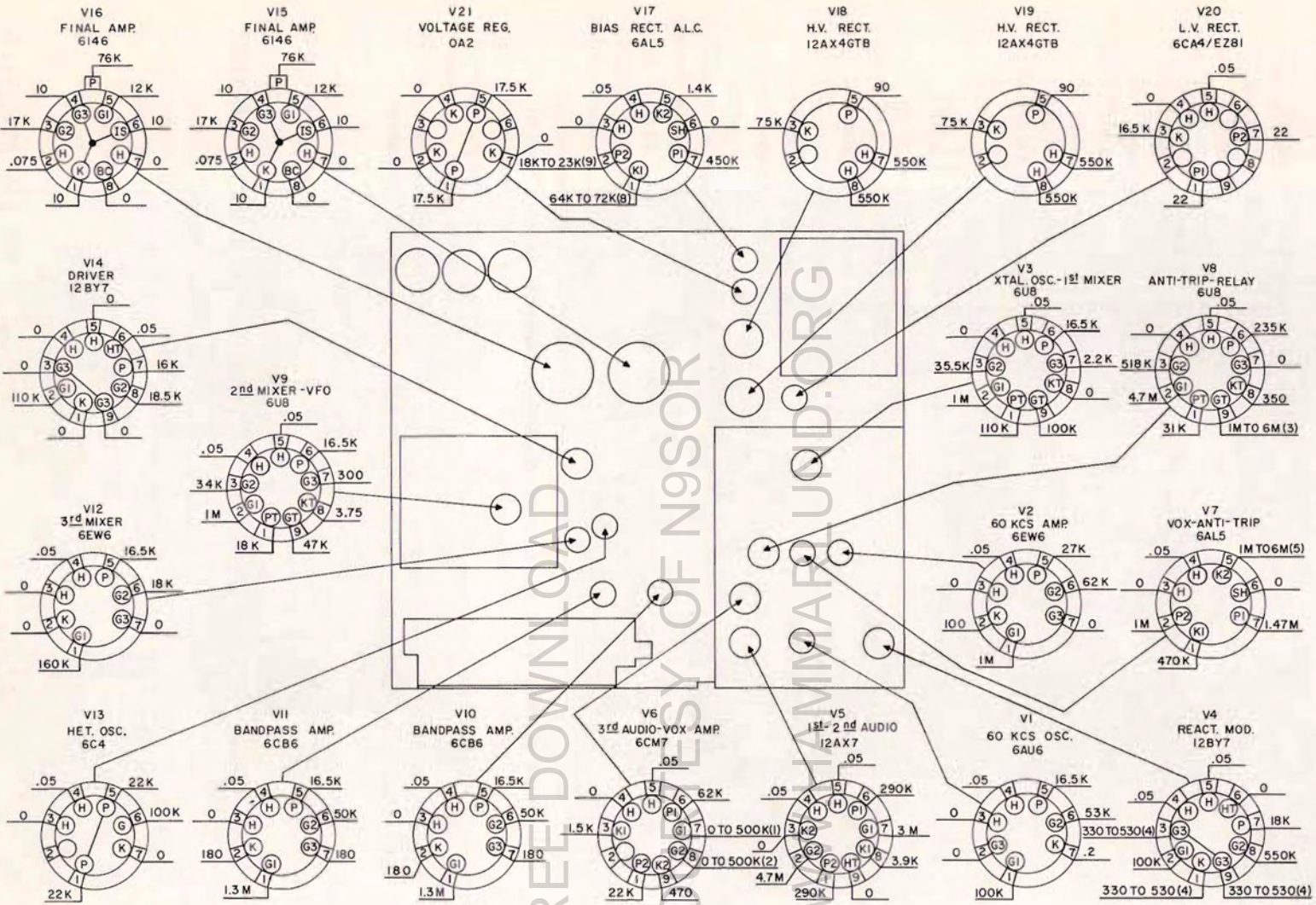

Figure 9. Top View of VFO Assembly Subchassis



**CONDITIONS**

- (A) RESISTANCE MEASUREMENTS MADE WITH 20,000 OHM/V METER FROM TUBE PIN TO CHASSIS.
- (B) FUNCTION SWITCH ON "LSB."
- (C) OPERATIONS SWITCH ON "OFF"
- (D) TUBE SOCKETS AND LOCATIONS ARE SHOWN IN BOTTOM VIEW.

**NOTES**

- (1) VARIES WITH POSITION OF "VOX SENS" CONTROL.
- (2) VARIES WITH POSITION OF "AUDIO LEVEL" CONTROL.
- (3) VARIES WITH POSITION OF "VOX DELAY" CONTROL.
- (4) VARIES WITH POSITION OF "FSK-FM ΔF" CONTROL.
- (5) VARIES WITH POSITION OF VOX SENS, ANTI-TRIP AND VOX DELAY CONTROLS.

**NOTES**

- (6) VARIES SLIGHTLY WITH "BIAS ADJ" CONTROL R136.
- (7) VARIES WITH TUBE CHARACTERISTICS.
- (8) VARIES WITH "ALC ADJ" CONTROL R124.
- (9) VARIES WITH POSITION OF "BIAS ADJ" CONTROL R136.
- (10) VARIES WITH POSITION OF "RF LEVEL" CONTROL R57.

**Figure 10. Resistance Chart**



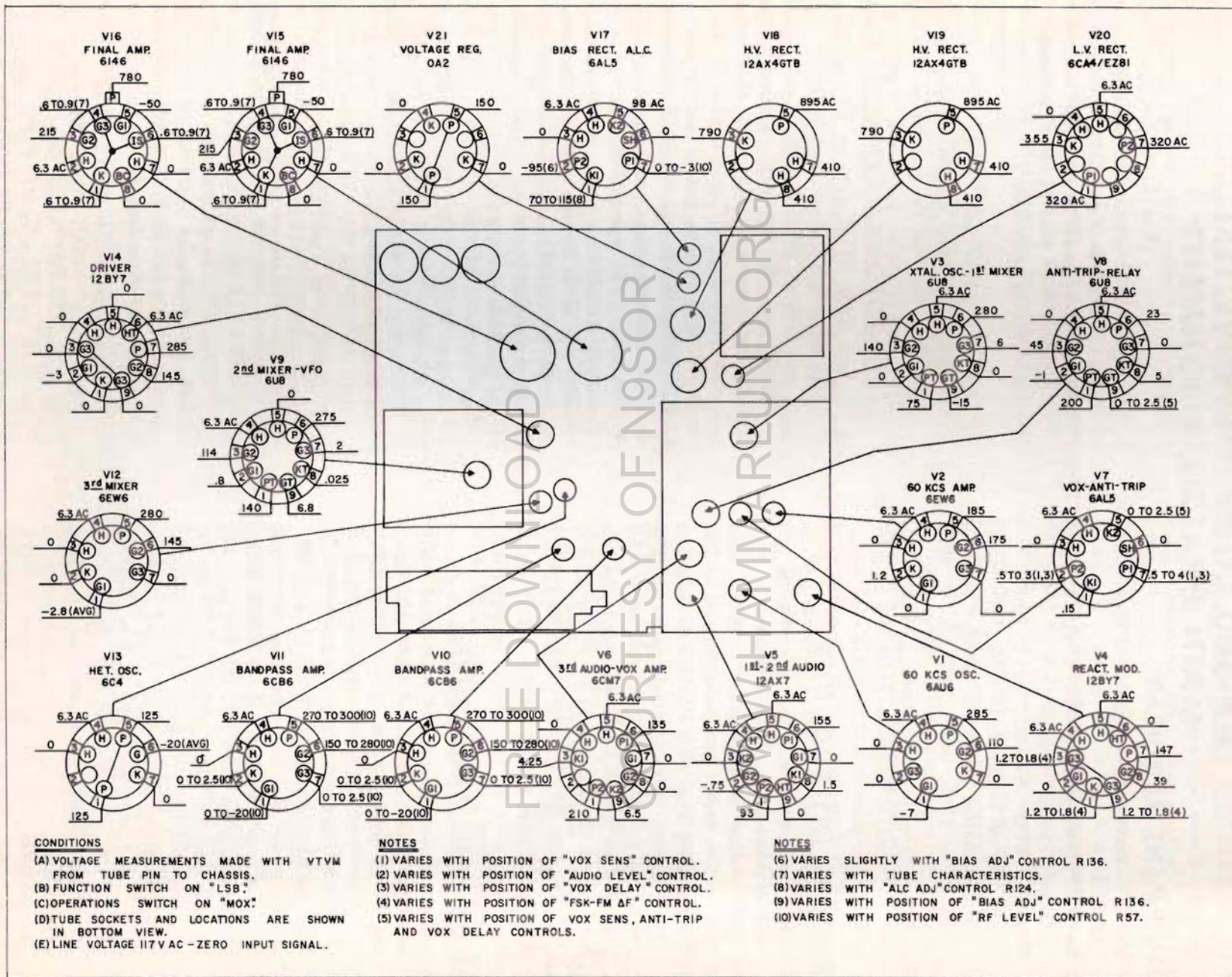

Figure 11. Voltage Chart







## HX-500 COMPREHENSIVE TEST MAIN CHASSIS ALIGNMENT

### EQUIPMENT REQUIRED:

1. Signal generator with a range of at least 3.3 to 30.5 MCS.
2. Hewlett Packard 410B VTVM.
3. Pretested "Exciter" chassis.
4. Pretested "VFO" chassis.
5. Dummy load and wattmeter, 50 ohms, 100 watts.
6. Crystal controlled heterodyne detector for 9.55, 13.05, 20.05, 27.05, 34.05, 34.55, 35.05, 35.55 MCS.
7. Crystal controlled generator for 5.775 and 5.8 MCS.

### GENERAL INSTRUCTIONS:

1. Mount and connect "Exciter" chassis and "VFO" chassis to "Main" chassis to be aligned using standard HX-500 cables. Connect 50 ohm dummy load and wattmeter to J10. Always start slug adjustments from bottom of can for bottom coils and single coils, and from top of can for top coils. If in doubt about position of slug, refer to fig. 12, run slug to the bottom or top of can, whichever is appropriate, then run slug into coil until maximum position is indicated.

### ALIGNMENT PROCEDURE:

1. Connect signal generator to junction of SB-3C and C124 (grid V14). Rotate "BIAS ADJ" control R136 maximum CW. Set "FUNCTION" switch to "LSB" and "OPERATIONS" switch to "MOX". Set "METER SENSITIVITY" to maximum CW position. Set "BAND SELECTOR" to 10M (28.0 - 28.5 MCS) observing SB-3A rear wafer so rotor extension rests on 34.05 crystal (5th position). Set C139, 140, 142, 143 and C149 for half capacity. With "DRIVE TUNE" set for maximum capacity set generator for about 2 volts output at 27.75 MCS. Adjust "FINAL TUNE" and generator level so that "LEVEL INDICATOR" M1 reads less than -20 DB. Peak bottom slug of L26 for maximum (insert tool from top) on M1.
2. Set generator to 30.25 MCS. Rotate "DRIVER TUNE" and "FINAL TUNE" to minimum capacity. Adjust C143 for maximum output.

### NOTE:

If oscillation occurs when adjustments are made check to see if C149 (neutralizing capacitor) is set at about half capacity (90 degree rotation from maximum capacity) then repeat step 1.

3. Turn OFF power and remove V18 and V19 (12AX4GTB'S) from sockets. Disconnect the +215 volt lead from the junction of R137 and R138. Turn ON power and feed a 29 MCS signal of 2 volts to Pin # 2 of V14. Connect a Hewlett Packard 410B VTVM probe to the junction of C148 and L30 (make sure that final tank cover is on). Rotate "DRIVER TUNE" and "FINAL TUNE" until HP 410B reads maximum. Adjust C149 for minimum on HP 410B. If necessary retune "FINAL TUNE" and C149 until reading on HP 410B is less than .1 volt. Disconnect HP 410B probe. Be sure to turn OFF power first before removing probe.
4. With power OFF, replace V18 and V19, and reconnect the +215 volt lead to the junction of R137 and R138. Remove V13 from its socket. Set C128, 129, 131, and 132 to half capacity.
5. Run top slug of T15 to top of can. Connect signal generator to Pin # 1 of V12. Turn ON power and rotate "DRIVER TUNE" to maximum capacity. With a 27.75 MCS signal into Pin # 1 of V12 rotate "FINAL TUNE" for maximum indication on M1. Adjust signal generator output to keep indication below -10 DB. Peak bottom slugs of L26 and T15 for maximum output on M1, readjusting signal generator level to keep output reading on M1 below -10 DB.
6. Set signal generator to 30.25 MCS. Rotate "DRIVER TUNE" to minimum capacity and "FINAL TUNE" for maximum on M1. Peak C143 and C132 for maximum on M1 keeping reading below -10 DB by means of signal input level. Repeat steps 5 and 6.
7. Set signal generator to 29 MCS. Peak "DRIVER TUNE" and "FINAL TUNE" for maximum on M1 (below -10 DB). Adjust top slug of T15 for maximum indication on M1. With wattmeter connected to load or with HP 410B probe connected to J10 increase signal generator output until



wattmeter reads at least 70 watts or HP 410B reads at least 60 volts. This is a check measurement.

8. Rotate "BAND SELECTOR" to 15M. Run top slug of T14 to top of can and set signal generator to 20 MCS. Rotate "DRIVER TUNE" to *maximum* capacity and "FINAL TUNE" for maximum indication on M1 (below -10 DB). Adjust top slug of L25 and bottom slug of T14 for maximum on M1 (below -10 DB).
9. Rotate "BAND SELECTOR" to 20M and set signal generator to 14.6 MCS. Set "DRIVER TUNE" to *minimum* capacity and "FINAL TUNE" for maximum indication on M1. Adjust C142 and C131 for maximum on M1 keeping level below -10 DB. Repeat steps 8 and 9.
10. Rotate "BAND SELECTOR" to 15M and set signal generator to 21.25 MCS. Adjust "DRIVER TUNE" and "FINAL TUNE" for maximum on M1 (below -10 DB). Peak top slug of T14 for maximum on M1 keeping level below -10 DB.
11. With HP 410B probe connected to J10 increase signal generator output until HP 410B reads at least 70 volts (or 95-100 watts on wattmeter connected to dummy load).
12. Rotate "BAND SELECTOR" to 40M and set signal generator to 6.95 MCS. Run top slug of T13 to top of can. Rotate "DRIVER TUNE" to *maximum* capacity and "FINAL TUNE" for maximum indication on M1 keeping reading below -10 DB. Adjust bottom slugs of L24 and T13 for maximum on M1 below -10 DB.
13. Set signal generator to 7.5 MCS. Rotate "DRIVER TUNE" to *minimum* capacity and "FINAL TUNE" for maximum indication on M1 below -10 DB. Adjust C140 and C129 for maximum on M1 below -10 DB. Repeat steps 12 and 13.
14. Set signal generator to 7.15 MCS. Peak "DRIVER TUNE" and "FINAL TUNE" for maximum indication on M1 below -10 DB. Adjust top slug of T13 for maximum on M1 below -10 DB.
15. With HP 410 B probe connected to J10 increase output until HP 410B reads at least 70 volts (or 100 watts on wattmeter connected to dummy load).
16. Rotate "BAND SELECTOR" to 80M and set signal generator to 3.3 MCS. Run top slug of T12 to top of can. Rotate "DRIVER TUNE" to *maximum* capacity and "FINAL TUNE" for maximum indication on M1 below -10 DB. Ad-

just top slug of L23 and bottom slug of T12 for maximum on M1.

17. Set signal generator to 4.15 MCS. Rotate "DRIVER TUNE" to *minimum* capacity and "FINAL TUNE" for maximum indication on M1 below -10 DB. Adjust C139 and C128 for maximum on M1 below -10 DB. Repeat 16 and 17.
18. Set signal generator to 3.75 MCS. Peak "DRIVER TUNE" and "FINAL TUNE" for maximum indication on M1 below -10 DB. Adjust top slug of T12 for maximum on M1 below -10 DB.
19. With HP 410B probe connected to J10 increase generator output until HP 410B reads at least 70 volts (or 100 watts on wattmeter).
20. Plug V13 into socket X13. Connect heterodyne detector to Pin #1 of V12. Set "BAND SELECTOR" to 80M and adjust C113 for zero beat with the heterodyne detector set for 9.55 MCS. Go from a lower capacity to a higher capacity and stop adjustment when a low frequency note is heard (about 100 cycles). Set "BAND SELECTOR" to 40M and heterodyne detector to 13.05 MCS. Adjust C114 for "zero" beat. Set "BAND SELECTOR" to 20M and heterodyne detector to 20.05 MCS. Adjust C115 for "zero" beat. Repeat above procedure for 15M, 10M, 10M, 10M and 10M bands setting heterodyne detector to 27.05, 34.05, 34.55, 35.05, and 35.55 MCS and adjusting C116, C117, C118, C119, and C120 for "zero" beat.
21. Remove heterodyne detector and connect HP 410B probe to Pin #1 of V12. Switch through all the bands with the "BAND SELECTOR" switch and note the voltage readings on the HP 410B. The readings should be not less than .6 volt nor more than 3 volts.
22. Connect the 5.775 and 5.8 MCS generator to Pin #2 of V9-A. With the generator set to 5.775 MCS increase the output of generator so it is possible to tune up transmitter in the 80M band at about 3.8 MCS. Adjust "R-F LEVEL" control if necessary to secure reading. Do not let the output meter read above -10 DB. Place a 1K resistor across the primary of T9 and adjust the top slug for maximum on M1. Adjust bottom slug of T8 for maximum on M1. Remove the 1K resistor from primary of T9 and connect across secondary of T9. Adjust bottom slug for maximum on M1 below -10 DB. Remove the 1K resistor. Set generator to 5.8 MCS. Place 1K resistor across primary of T10 and adjust top slug



of T10 for maximum on M1. Remove 1K resistor from primary of T10 and connect across the secondary of T10. Adjust bottom slug of T10 for maximum on M1. Remove 1K resistor from secondary of T10 and connect across primary of T11. Follow the same procedure as used for T10, then remove the 1K resistor.

23. Remove generator and rotate "FUNCTION" switch to "DSB". Tune up transmitter on 80M band, keeping output below -20 DB. Peak top and bottom slugs of T4 and top and bottom slugs of T6 for maximum on M1.
24. Remove V13 from its socket and connect the HP 410B probe to Pin #1 of V12. Rotate "FUNCTION" switch to "LSB". Set HP 410B to the 1 volt AC scale. Connect the variable signal generator to Pin #2 of V9-A with the out-

put set for .05 volts (50,000 uv). Set signal generator to 5.8 MCS and adjust "R-F LEVEL" control so that HP 410B reads .5 volt. Scan the range of 5.55 to 6.05 MCS. Note the frequency of maximum output indicated on the HP 410B. Set the signal generator to the frequency of maximum response and adjust the "R-F LEVEL" control so that the HP 410B reads exactly 1 volt (full scale). Rotate the signal generator dial slowly to cover approximately 5.5 to 6.15 MCS. At 5.5 MCS the HP 410B should read less than .1 volt. As the signal generator is rotated slowly toward the 6.15 MCS point the .5 volt indication on the HP 410B should occur below 5.55 MCS (between 5.5 and 5.55 MCS). From 5.55 to 6.05 MCS the HP 410B should not read lower than .5 volts. The HP 410B should read less than .1 volt at 6.15 MCS.

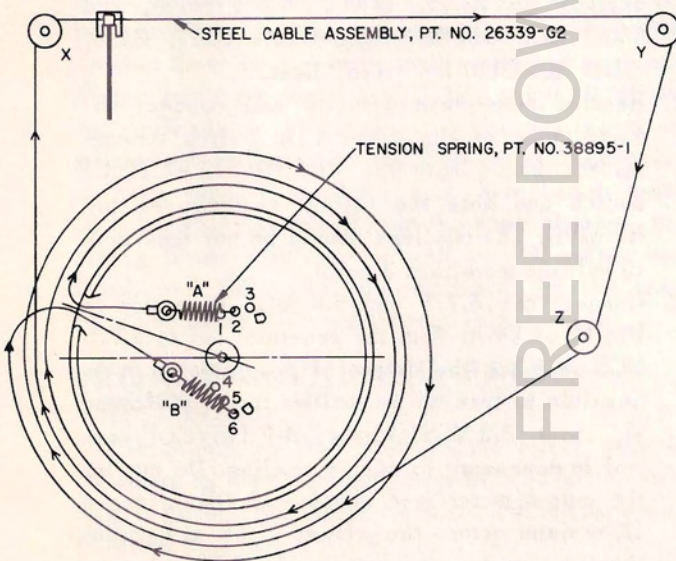

Figure 12. Dial Cord Stringing Diagram

#### INSTRUCTIONS FOR STRINGING DIAL CORD

Turn Frequency Knob clockwise until the stop position is reached. The dial drum will then be in the position as shown in Figure 12. Hook spring "A" in Hole #1 and wind cable clockwise around drum almost two (2) turns. Then wind cable up and over the pulleys X, Y, and Z. Wind cable approximately 1-1/2 turns around dial drum and hook the spring "B" in Hole 4, 5, or 6. For satisfactory operation each spring should be stretched approximately 1/4 inch. Adjust each spring accordingly for equal tension.

When stringing the dial cord maintain a constant tension on the cable (approximately 1/8 inch spring stretch) and avoid cable crossovers on dial drum. Start by running cable on far side of the groove (nearest to frame) and work toward the near side. When stringing has been completed, rotate the Frequency tuning knob across the entire range of travel and check for string crossovers and eliminate them.

Rotate Frequency knob clockwise to end of travel. At this point the VFO tuning capacitor C91 will be at maximum capacity. Check capacitor alignment carefully with the aid of an offset level gauge. The edges of the longer side rotor plates must be at the exact level (or in line) with the adjacent edges of the stator plates. Adjust if necessary by loosening the set screws on one side of the flexible coupling.

Insert pointer on track and check ease of travel. Add lubricating grease if necessary. Avoid bending the pointer. Set pointer directly over the dot marking located on the extreme right (front view of dial mechanism) of the drum when band change switch indicates 80M Band. Insert dial cable into the "pointer fingers" and with the aid of a pair of long nose pliers, crimp the fingers of the dial pointer. Recheck the stringing and alignment of the dial cable assembly.

Figure 12. Instructions for Dial Cord Stringing



## HX-500 COMPREHENSIVE TEST EXCITER ALIGNMENT

### EQUIPMENT REQUIRED:

1. Variable frequency signal generator covering at least 56 to 64 KCS.
2. 100 KCS Frequency counter.
3. HQ-180 receiver or equivalent.
4. 10 KCS and 100 KCS frequency standard.
5. Hewlett Packard 400C VTVM (AC).
6. Pretested HX-500 "Main" chassis.

### GENERAL INSTRUCTIONS:

Connect untested "Exciter" chassis to "Main" chassis by means of an extended cable between J2 and P2. Due to sideband reversal in the third mixer stage on the main chassis, the "Function" switch indicates LSB on position #1. However, the 60 KCS filter passes the upper sideband in this position, and it is this position (LSB on "Function" switch) that is used to align the 60 KCS coils.

Always start slug adjustments from the bottom of can for bottom and single coils and from the top of can for top coils. If in doubt about the position of the slug, run the slug to the bottom or top of can, whichever is appropriate, then run slug into the coil until resonance is indicated as outlined below under Alignment. Refer to schematic diagram where arrows indicate top and bottom slugs.

### ALIGNMENT PROCEDURE:

1. Rotate all potentiometers CCW. Set "Function" switch to DSB and "Operations" switch to MOX. Connect the frequency counter across R8. Adjust L1 so the counter reads between 59.995 and 60.005 KCS. Remove counter.
2. Connect HQ-180 receiver to J1. Rotate "Operations" switch to OFF. Using the 10 KCS and 100 KCS standard connected to the HQ-180 antenna input, tune the receiver to exactly 1590 KCS using the BFO if necessary. Turn off the 100 KCS standard and the BFO. Rotate the "Operations" switch to MOX and adjust C42 to zero beat with the 10 KCS standard.
3. Run top slug of T3 to top of can. Tune HQ-180 to 1650 KCS. Adjust T3 bottom slug and T4 top and bottom slugs for maximum on the HQ-180 level meter. Be sure to adjust HQ-180 RF gain

control so as not to overload the receiver or an S meter indication of S7 to S9.

4. Tune HQ-180 to 1590 KCS. Adjust top slug of T3 for minimum indication on HQ-180 level meter. Tune receiver to 1650 KCS and readjust bottom slug of T3, then tune receiver to 1590 KCS and adjust top slug of T3, for minimum on HQ-180 meter. Remove V1 from its socket.
5. Rotate "Function" SW to LSB. Feed a 61, 300  $\pm$ 5 cycle signal across L7 of approximately 2 volts. With the HP 400C connected to J1 through a short, low capacity cable, place L8 and L9 for maximum on the HP 400C, on .003 V scale.
6. Connect generator across L5. Run slug of Z1 to bottom of can and peak L6 and L7. Connect a 10K resistor across C13 and a second across L7. Peak L6 for maximum on HP 400C. Do not use a scale higher than .01 volts. Remove resistors from across C13 and L7, and connect them across L6 and L8. Peak L7 and L9 for maximum on HP 400C. Remove resistors from across L6 and L8 and connect them across L7 and L9. Peak L8 for maximum on HP 400C. Remove the 10K resistors.
7. Connect the HP 400C across L8. Set signal generator to 60.000 KCS  $\pm$ 5 cycles, and reduce generator output to .02 volts. Peak T2 for maximum on HP 400C.
8. Set signal generator to 59.500 KCS  $\pm$ 5 cycles, keeping the output at .02 volts. Adjust Z1 for *minimum* on HP 400C. The level should drop at least 20 db from the output obtained with Z1 slug bottomed, to the point of *minimum* output as Z1 slug is adjusted.
9. Remove HP 400C from across L8 and connect to J1. Set the HP 400C on the .01 volt scale. Tune the signal generator with approximately .1 volt output, near 62.340 KCS for *maximum* on the HP 400C. This should be between 62.320 and 62.360 KCS. Adjust generator output so that HP 400C reads 0 db on the .01 volt scale. Tune the generator lower in frequency until a null is reached. This should be between 61.270 and 61.310 KCS and the reading on the HP 400C should be -15 to -18 db from the 0 db point on the .01 volt scale. Tune the generator lower in frequency until another peak is reached between



- 60.300 and 60.350 KCS. This peak should be not more than  $-3$  db of that obtained near 62.340 KCS. If not within specs repeat 6 but do not readjust Z1 except for recheck of slot.
10. Rotate the "Function" switch to USB, and using the same input level required to test the LSB, tune the generator for maximum between 59.630 and 59.700 KCS. Maximum output as recorded on the HP 400C should lie between the above frequencies and be no more than 1 db from the maximum output on the LSB position. Adjust generator output so HP 400C reads 0 db on the .01 volt scale. Tune the generator between 58.600 and 58.650 KCS for *minimum* indication on the HP 400C. The point of minimum response should lie between the above frequencies and be  $-15$  to  $-18$  db down from the maximum near 59.650 KCS. Tune the generator between 57.600 and 57.670 KCS for maximum response. This should be between the above frequencies and not more than  $-3$  db down from the maximum near 59.650 KCS.
  11. Remove V1 from socket. Rotate "Function" switch to LSB. Connect the signal generator in series with a 4700 ohm  $\frac{1}{2}$  watt resistor across R8. Set the generator to 61.250 KCS  $\pm 5$  cycles, and adjust the generator output so the HP 400C reads on the .03 volt scale connected across L6. Adjust L3, L4 and L5 for *maximum* on the HP 400C.
  12. Set generator output to approx. .5 volts. Connect a 10K ohm  $\frac{1}{2}$  watt resistor across L4 and adjust L3 and L5 for maximum on the HP 400C using the .03 volt scale. Remove the 10K resistor from L4 and connect it across L5. Adjust L4 for maximum on HP 400C, then remove resistor from across L5. Connect HP 400C to J1.
  13. With the HP 400C on the .003 volt scale, slowly tune the generator between 60.000 and 63.000 KCS. Find the frequency of maximum output and adjust the signal generator so the HP 400C reads 0 db on the .003 volt scale. Tune the signal generator lower in frequency until the output reads  $-6$  db between 60.280 and 60.320 KCS. Slowly tune the generator higher in frequency noting that the output as read on the HP 400C .003 volt scale does not drop lower than  $-4$  db, until between 62.250 and 62.400 KCS the HP 400C will read  $-6$  db and will read lower as the frequency is increased beyond 62.400 KCS.
  14. Rotate "Function" switch to USB. Find the frequency of maximum output between 57.600 and 59.700 KCS. This output should be no lower than  $-2$  db from that obtained on the LSB position with the same signal generator output. Increase generator output until HP 400C reads 0 db on the .003 volt scale. Tune the signal generator lower in frequency until the output reads  $-6$  db between 57.650 and 57.750 KCS. Slowly tune the generator higher in frequency noting that the output as read on the HP 400C .003 volt scale does not drop lower than  $-4$  db until between 59.680 and 59.720 KCS the HP 400C will read  $-6$  db and will read lower as the frequency is increased beyond 59.720 KCS.
  15. Replace V1 in its socket and connect the HP 400C across R8. Rotate "Function" switch to DSB position. Using the 10 volt scale of the HP 400C, adjust T1 for maximum. This should be 4 volts T1 volt. Remove generator. Remove HP 400C.
  16. Connect counter across R8 and adjust L1 to 60.000 KCS  $\pm 5$  cycles. Rotate "Function" switch to FSK. With counter across R8 and FSK-FM knob on panel maximum CCW, frequency reading of the counter should be 60.000 KCS or lower. Rotate FSK-FM knob on panel maximum CW. Frequency reading on counter should increase at least 1 KC higher.
  17. Repeat step 16 with "Function" switch on FM.
  18. Rotate "Function" switch to DSB. With HP 400C connected to J1, adjust C58 with an insulated (plastic or fibre) screwdriver so that HP 400C reads between .005V and .008 volts on the .01 volt scale.
  19. Rotate "Function" switch to LSB. Rotate "Audio Level" control fully CW. The HP 400C should read less than .0005 volt on the .001 volt scale. If much higher reading is obtained check mike connector and make sure it is shorting.
  20. Using the same settings as in step 19, connect a microphone to the "Mike" input on the front panel and rotate the "Audio Level" control maximum clockwise. Whistle closely into the microphone observing that the HP 400C meter swings to at least .008 volt on the .03 volt scale. Rotate "Operations" switch to VOX.
  21. Using the same settings as in step 20, rotate the "VOX SENS" control CW until the VOX relay and antenna relay operate. This should



occur about half rotation of the "VOX SENS" control. While periodically talking into the microphone with the VOX relay operating, advance the "VOX DELAY" slowly from CCW to CW and note the approximate time required for the VOX and antenna relays to return to normal position. The time required should increase until at the maximum CW position of the "VOX DELAY" control, approximately two seconds or

more will elapse until the VOX and antenna relays return to normal position.

22. Connect a 1000 cycle 2V signal to pin #11, of J2 and ground. With the "VOX SENS" control advanced just enough to allow the VOX and ANT relays to operate, rotate the "ANTI-TRIP SENS" control CW and note that the VOX and ANT relays close to operate while talking into the microphone.

## HX-50 COMPREHENSIVE TEST VFO ALIGNMENT

### EQUIPMENT REQUIRED:

1. Crystal controlled signal generator with outputs of 5.5 MCS - 5.775 MCS and 6.15 MCS.
2. HX-500 "Main" chassis completely aligned.
3. HX-500 "Exciter" chassis completely aligned.
4. Dummy Load (Two 60 watt bulbs in parallel).
5. HQ-180 Receiver.

### GENERAL INSTRUCTIONS:

The "VFO" chassis will be aligned at the same position as the "Exciter" chassis. Pairing of the VFO and the Exciter is to be preferred, and units aligned together should be placed on the same "Main" chassis.

Pair a tested "Exciter" chassis with an untested "VFO" J8 and P8, J2 and P2, and J7 and J9. When connections from J1 to J6, and J7 to J9 are required, the connecting test cable should be about 2 feet in length and the same material as is used on a complete HX-500.

### ALIGNMENT PROCEDURE:

1. Connect the crystal controlled signal generator to pin #2 of V9-A.
2. Use transmitter output meter. Tune to approximately 3.8 MCS on 80 meter band. Run slugs of Z2 to top and bottom of can.
3. Set generator output to 5.775 MCS. Place a 1K resistor across secondary of T9 on "Main" chassis. Peak T8, then T7 for maximum deflection on transmitter level meter. Reduce generator output level sufficiently to prevent meter from reading above -20 db.
4. Connect HQ-180 to J7. Set generator to 6.15

MCS. Adjust bottom slug of Z2 for *minimum* indication on receiver S meter with the receiver tuned to 6.15 MCS. Adjust R86 and bottom slug of Z2 alternately until further adjustment does not reduce level meter indication.

5. Set generator to 5.5 MCS. Adjust top slug of Z2 for *minimum* indication on receiver S meter with receiver tuned to 5.5 MCS. Repeat step 4.
6. Remove generator leads from pin #2 of V9-A. Connect cable between J1 and J6. Rotate "Function" switch to DSB. Tune receiver to 5.6 MCS with 100 KCS calibrator on. Tune VFO to 3.95 MCS (on 80 M band) as indicated by the dial pointer with the vernier tuning on "0". Adjust L17 for zero beat with the 100 KCS calibrator.
7. Tune receiver to 6 MCS. Tune VFO to 3.55 MCS as indicated by the dial pointer with the vernier tuning on "0". Adjust C-92 for zero beat with the 100 KCS calibrator.

### NOTE:

If beat note is weak, adjust top and bottom slugs of T6.

8. Repeat steps 6 and 7 until no adjustment is necessary on L17 and C92 for zero beat.
9. Remove receiver input lead from J7 and connect J7 to J9 with the extended test cable. Throw the "Function" switch to DSB and "Operations" switch to MOX. Tune up HX-500 to 3.75 MCS on the 80 M band. Peak top and bottom slugs of T6 for maximum output on level meter. Start at about -40 db and reduce R-F level control to keep the meter from reading over -20 db.



## HX-500 COMPREHENSIVE TEST OVERALL ALIGNMENT & TEST

### EQUIPMENT REQUIRED:

1. M.C. Jones Model 263.3 Micromatch RF Power and VSWR meter and coupler unit.
2. M.C. Jones 636N 50 ohm load resistor.
3. Connecting cables for power meter and load.
4. HQ-170 or HQ-180 receiver or equivalent.
5. Microphone (Hi-Z).
6. Key (Bug)
7. Oscilloscope and capacity divider probe.
8. Two tone audio generator, 400 and 1000 cps.
9. 0-300 MA or 0-3V meter.

### GENERAL INSTRUCTIONS:

1. Connect receiver to HX-500 as in a regular amateur station. Use Fig. 2 in instruction book. Connect M.C. Jones Power and VSWR meter and load Resistor to J10. Connect 0-300 MA meter to terminals 13 (ground) and 14 (plus) on J-11 connector on rear apron of HX-500.
2. The overall test is to be performed in the following sequence:
  - A. Check & align V.F.O.
  - B. Adjust bias.
  - C. Two Tone test and C-58 adjust.
  - D. Output power test.
  - E. C.W. Test.
  - F. Phone Test.
  - G. Check and adjust F.S.K.
  - H. A.L.C. adjust.

### ALIGNMENT PROCEDURE:

1. Rotate "operations" switch to "St By" and "Function" switch to "DSB". Set "Band Selector" to 80M and "ALC ADJ." to maximum CW position. Allow about 30 minutes warm-up time.

Warmup may be done prior to final test by allowing assembled units to heat up before start of tests. Do not turn HX-500 off for more than a few minutes while connections are made for final test if it is necessary to do so for any reason.

2. Rotate "operations" switch to "CAL" position. Tune receiver and HX-500 to exactly 4 mcs.

Using the receiver 100 KCS calibrator, make sure that both the HX-500 scale pointed and "Frequency KCS" dials are on exactly 4.0 mcs and "0" respectively. Adjust L17 for zero beat with the 100 kcs calibrator. Advance HX-500 "Calibrate Level" control as required to obtain a strong beat note in the receiver. Tune HX-500 and receiver to exactly 3.5 mcs again making sure the HX-500 scale pointer and "Frequency KCS" dial are on 3.5 MCS and "0" respectively. Adjust C92 for zero beat. Retune HX-500 and receiver to exactly 4 MCS. Readjust L17 for zero beat. Retune HX-500 and receiver to exactly 3.5 MCS. Adjust C92 for zero beat. Repeat above procedure until a beat note if less than 100 cycles is heard when tuned to either 4 MCS or 3.5 MCS. Tune HX-500 and receiver simultaneously to 3.6, 3.7, 3.8, and 3.9 MCS resting the "Frequency KCS" dial on "0" as the pointer rests on or near the frequency marking. Listen at each frequency as it beats with the 100 KCS calibrator. If a beat note of less than 5 KCS is heard the VFO and dial calibration is acceptable.

3. Observe the 0-300 milliammeter and note the reading. Adjust the "BIAS ADJ." control, R136, until meter reads 60 MA.
4. Tune up HX-500 to 3.75 mcs as per instruction book. Set meter M1 to ODB with the "Meter Sens" control on the front panel. Adjust "RF Level" control so meter reads -10 DB. Rotate "Function" switch to "LSB" position. Connect low capacity divider probe from the oscilloscope vertical deflection plates to J10 on the transmitter. Feed the two tone audio generator output (400 and 1000 cycles) to the "Patch" input on transmitter. Advance the "Audio Level" control maximum CW. Rotate "Audio Level" control CCW to the position where pattern on oscilloscope exhibits no sign of flutter at the tips. Note setting for Step 9. Adjust "RF Level" control until current meter reads approximately 160 ma and scope picture just shows signs of flat-topping. The "RF Level" control should read "7" or less. Switch to "DSB" and rotate "Audio Level" control to "0". Adjust C58 from start at minimum capacity until meter reads 250 ma. Switch back to "LSB" and check pattern for linearity



on oscilloscope by advancing "Audio Level" control CW. Repeat for "USB" position. Rotate "Audio Level" control maximum CCW and observe level indicator M1. Reading in either "USB" or "LSB" position of the "Function" switch should be less than -50 db with the "Operations" switch on "MOX".

5. With "Operations" switch on "MOX" and "Function" switch on "DSB", tune up transmitter first at 3.5 mcs and then at 4 mcs in the 80M band. At each frequency rotate "RF Level" control until power meter reads 100 watts or over. Observe the current meter and note that the reading does not exceed 260 ma. Rotate "Band Selector" to 40M. Record power output and current readings as above at 7 and 7.5 mcs. Rotate "Band Selector" to 20M, 15M, and the four 10M bands, each time checking for power and current readings at the scale extremes as above.

**NOTE:**

On the 10M bands an output power reading of 70w. or better is acceptable.

6. Connect the key (bug to "Key" jack on the front panel. Rotate "Function" switch to "CW". Operate key and note that power output with the key down is over 100 watts. Send a series of dots and note the rise and decay time of the RF power on the oscilloscope. This should be similar to that observed on a tested and approved HX-500.
7. Connect a microphone to the "Mike" input on the front panel. Rotate "Function" switch to "LSB". Advance the "Audio Level" control to

about "5" and talk into the microphone. Observe the RF signal on the oscilloscope.

8. Rotate "Function" switch "FSK" and "Operations" switch to "CAL". Tune receiver to 3.75 mcs and set receiver BFO to zero beat with 3.75 mcs signal from HX-500. Connect the key (bug) to pins #11 and #12 of J11. While sending a series of dots, rotate the "FSK DEVIATION" control, R140, until a low beat note is heard in the receiver each time the key makes contact. This sets the "FSK DEVIATION" control at the minimum deviation (zero) position. Send a series of dots and rotate the "FSK DEVIATION" control first CW and then CCW from the point of "Zero" beat. As the control is advanced in either direction, a series of dots sent with the key should increase in audio pitch to at least 1500 cycles. As shipped from the factory after tests the "FSK DEVIATION" control R140, should be set at the extreme CW position.
9. With two tone audio generator and oscilloscope connected as in Step 5, tune up transmitter on "DSB" position in the 80M band at 3.75 MCS. Set meter indication to ODB with the "Meter Sensitivity" control and then adjust "RF Level" control until meter reads -10 db. Switch to "LSB" position and advance "Audio Level" control to exact position obtained in Step 4 where pattern on oscilloscope shows no signs of flutter. Advance "RF Level" control until there is a definite flat-topping of pattern on oscilloscope. Adjust "ALC ADJ" control, R124, until the pattern returns to original shape at top of wave form. This completes the test and alignment of the transmitter.





## MAIN CHASSIS PARTS LIST HX-500

SCHEMATIC DESIGNATION	DESCRIPTION	HAMMARLUND PART NO.
<b>CAPACITORS</b>		
C100 C101, C110 C102, C106, C183, C186, C187 C103, C107, C112, C122, C123, C125, C137, C145, C155, C156, C159, C160, C173, C184 C185, C189 C104, C109 C105 C108, C162, C163, C170 C111, C190 C113, C114, C115, C116, C117, C118, C119, C120 C121 C124, C136 C126, C175, C176, C177, C178, C179, C180, C181, C182 C127 C128, C129, C131, C132, C139, C140, C142, C143 C130, C141 C133 C134 C135 C138 C144, C146 C147, C148 C149 C150 C151, C154 C152 C153 C157 C161 C164, C165 C166 C167 C168, C169 C171, C172 C188	Fixed Silver Mica, 8 mmf, 500 W.V.D.C. Fixed Silver Mica, 10 mmf, 500 W.V.D.C. Fixed Ceramic Disc, .1 mfd, 50 W.V.D.C.  Fixed Ceramic Disc, .01 mfd, 500 W.V.D.C.  Fixed Silver Mica, 17 mmf, 500 W.V.D.C. Fixed Silver Mica, 47 mmf, 500 W.V.D.C. Fixed Ceramic Disc, .001 mfd, 500 W.V.D.C. Fixed Silver Mica, 3 mmf, 500 W.V.D.C. Variable Mica, 1.5 - 20 mmf  Fixed Paper, .5 mfd, 200 W.V.D.C. Fixed Ceramic Disc, 100 mmf, 1000 W.V.D.C. Fixed Ceramic Disc, .005 mfd, 500 W.V.D.C.  Fixed Silver Mica, 47 mmf, 500 W.V.D.C. Variable 5-25 mmf  Fixed Silver Mica, 110 mmf, 500 W.V.D.C. Variable Air, (Driver Tuning) Fixed Ceramic Disc, .0027 mfd, 500 W.V.D.C. Fixed Button Mica, .002 mfd, 500 W.V.D.C. Fixed Silver Mica, 33 mmf, 500 W.V.D.C. Fixed Ceramic Disc, .005 mfd, 1000 W.V.D.C. Fixed Ceramic Disc, .001 mfd, 3000 W.V.D.C. Variable Air, (Neutralizing) Variable Air, (Final Tune) Fixed Silver Mica, 330 mmf Fixed Silver Mica, 270 mmf Fixed Silver Mica, 220 mmf Fixed Silver Mica, 18 mmf, 500 W.V.D.C. Fixed Paper, .1 mfd, 400 W.V.D.C. Electrolytic, 40 mfd, 500 W.V.D.C. Electrolytic, 40/40 mfd, 450/450 W.V.D.C. Electrolyte, 5 mfd, 6 W.V.D.C. Electrolytic, 20 mfd, 150 W.V.D.C. Fixed Ceramic Disc, .01 mfd, 1400 W.V.D.C. Fixed Silver Mica, 1 mmf, 500 W.V.D.C.	K23006-73 K23006-22 M23034-29  M23034-28  K23006-82 K23006-6 K23034-30 K23006-42 K23043-6  K23045-6 K23034-34 K23034-31  K23006-80 K23038-3  K23006-74 M42324-1 M23034-33 K23922-1 K23006-65 K23034-10 M23034-32 K34452-G43 M4112-G32 K23071-321 K23071-319 K23071-318 K23006-77 K23045-1 K15504-45 K15504-56 K23091-8 K23073-77 M23034-26 K23006-36
<b>COILS</b>		
L22, L34 L23 L24 L25 L26 L27, L28 L29 L30 L31 L32 L37 L38 L39 L40 L41	R.F. Choke 2.5 Millihenries Band 1 and 2 Driver Coil Assembly Part of L23 Band 3 and 4, 5-8, Driver Coil Assembly Part of L23 Parasitic Choke Final Plate Choke Final Tank Coil Assembly R.F. Choke, 2.5 Millihenries Filament Choke R.F. Choke, 2.0 Microhenries R.F. Choke, 3.9 Microhenries R.F. Choke, 5.6 Microhenries Filter Choke, 13 henries Filter Choke, 8 henries	K42335-1 K42322-1  K42323-1  K42355-1 K42353-1 K42358-1 K42344-1 K42354-1 K42376-1 K42356-12 K42356-14 K42357-1 K26302-1
<b>RESISTORS</b>		
R100, R105, R129, R153 R101, R106 R102, R148, R149, R157, R158 R103, R107, R154, R155, R156 R104, R108, R111, R113 R117 R109, R114, R125 R110, R123 R112 R115, R146 R116, R127	470K ohms, 1/2 w., 10% 180 ohms, 1/2 w., 10% 1 Megohm, 1/2 w., 10%  33K Ohms, 1/2 w., 10%  1K ohms, 1/2 w., 10%  100K ohms, 1/2 w., 10% 47K ohms, 1/2 w., 10% 4.7K ohms, 1 w., 10% 220K ohms, 1/2 w., 10% 15K ohms, 1/2 w., 10%	K19309-113 K19309-31 K19309-121  K19309-85  K19309-49  K19309-97 K19309-89 K19310-65 K19309-105 K19309-77



## MAIN CHASSIS PARTS LIST HX-500 (Cont'd)

SCHEMATIC DESIGNATION	DESCRIPTION	HAMMARLUND PART NO.
<b>RESISTORS</b>		
R118 R119,R122 R120,R121 R124 R126 R128 R130,R131, R132 R133 R134 R135 R136 R137,R138 R139 R140 R141 R142 R143 R144 R145 R147 R151 R152	1K ohms, 1 w., 10% 100 ohms, 1 w., 10% Part of Parasitic Choke (L27,L28) Variable, 50K (ALC ADJ) 4.7K ohms, 1/2 w., 10% 2.2 Megohms, 1/2 w., 10% 40K ohms, 5 w., 10% 220 ohms, 5 w., 10% 1.5K ohms, 1 w., 10% 10K ohms, 1 w., 10% 10K ohms, 1/2 w., 10% Variable, 5K ohms (Bias Adj.) 1.5K ohms, 10 w., 10% 82 K ohms, 1/2 w., 5% Variable, 50K ohms (FSK DEV) 22K ohms, 1/2 w., 5% 10 ohms, 1/2 w., 5% 30 ohms, 1/2 w., 5% 1K ohms, 1/2 w., 5% 15K ohms, 1 w., 10% 6.2K ohms, 1/2 w., 5% 6.8K ohms, 2 w., 5% 2.2K ohms, 1 w., 5%	K19310-49 K19310-25  K15380-4 K19309-65 K19309-129 K19339-2 K19339-3 K19310-53 K19310-73 K19309-73 K15380-3 K19337-6 K19309-287 K15380-4 K19309-178 K19309-246 K19309-190 K19309-267 K19310-77 K19309-176 K19304-262 K19310-189
<b>TRANSFORMERS</b>		
T9 T10,T11 T12 T13 T14 T15 T16 T16	Transformer, Bandpass Input Transformer, Bandpass Transformer, 80M, Mixer Transformer, 40M Mixer Transformer, 15-20M Mixer Transformer, 10M Mixer Transformer, Power, 117V a.c. Transformer, Power 117-230V a.c. (Export)	M42328-1 M42329-1 K42365-1 K42366-1 K42367-1 K42368-1 K42351-1 K42351-2
<b>SWITCHES</b>		
SB-3A SB-3B SB-3C,SB-3E SB-3D,SB-3F SB-3G SB-3H	Switch Wafer, Het Osc. Switch Wafer, 3rd Mixer Plate Switch Wafer, Driver, Final Grids Switch Wafer, Driver, Final Grids Switch Wafer, Final Amp. Tank Switch Wafer, Final Amp. Tank	M26453-1 M26453-2 M26453-3 M26453-4 M26453-5 M26453-6
<b>MISCELLANEOUS</b>		
CR3 CR4 DS-1,DS-2,DS-3, DS-4 E1 F1 J9 J10 J11 J13 J14 K1 K2 P2 P8 Y2 Y3 Y4 Y5 Y6 Y7 Y8 Y9	Diode, Germanium 1N34A Diode Silicon HD6164 Lamp, Incandescent #47  Fuse Holder Fuse, Slo Blow, 6-1/4 Amp. Connector, Female Connector, Receptacle Connector, Female Power Outlet (Fan) Connector, Female Relay, 3PDT (VOX) Relay, SPDT (ANTENNA) Connector, Female, 16 pin Connector, Female, 4 pin Crystal Unit, 9.55 Mcs Crystal Unit, 13.05 Mcs Crystal Unit, 20.05 Mcs Crystal Unit, 27.05 Mcs Crystal Unit, 34.05 Mcs Crystal Unit, 34.55 Mcs Crystal Unit, 35.05 Mcs Crystal Unit, 35.55 Mcs	K41205-1 K41208-1 K16004-1  K15923-5 K51010-1 K42123-1 K16111-1 K41124-1 K35013-1 K42123-1 K40380-4 K40380-5 K41117-2 K41117-1 M42378-1 M42378-2 M42378-3 M42378-4 M42378-5 M42378-6 M42378-7 M42378-8
<b>MECHANICAL</b>		
	Knob, Frequency Knob, Band Selector Knob, Final Knob, Driver Tune Knob, Function	M42418-G1 M42417-G1 K42413-G1 K42416-G1 K42414-G1



## MAIN CHASSIS PARTS LIST HX-500 (Cont'd)

SCHEMATIC DESIGNATION	DESCRIPTION	HAMMARLUND PART NO.
<b>MECHANICAL</b>		
	Knob, Operations Knob, Calibrate, Meter, R.F., Audio Knob, small Knob, Drag-Lock Meter Lamp Bracket Fan Assembly Motor, Fan Fan Blade Male Plug (Motor) Knob, Neutralizing Dial Cable Assembly Connector, External Conn. Plug, Receiver Antenna Panel Screws Dial and Tuning Drive Assembly Escutcheon Window Frame (Panel) Felt Foot (Cabinet) Dial Pointer Bead Chain Bead Chain Splicing Link	K42415-G1 K42412-G1 K42435-1 K42489-1 K42312-1 PL42401-G1 K51006-1 K50033-1 K51011-1 K26216-1 K26339-G2 K41125-1 K35610-1 K10047-15 PL42380-G1 P42359-1 M42434-1 P42408-1 K3919-3 K42438-1 K42473-2 K50035-1

## EXCITER PARTS LIST HX-500

SCHEMATIC DESIGNATION	DESCRIPTION	HAMMARLUND PART NO.
<b>CAPACITORS</b>		
C1, C12, C13, C60 C2, C4, C24 C3, C9, C11, C20, C21, C46, C48, C55 C5, C16 C6 C7, C10, C27, C51, C56 C8, C19, C25 C14 C15, C17 C18 C22 C23, C39 C26, C49, C53, C54, C61 C28, C29, C32, C33, C35, C38, C40, C57 C30, C41 C31 C34, C37 C36 C42 C43 C44 C45, C47 C50 C52, C59 C58 C62	Fixed Silver Mica, 220 mmf, 500 W.V.D.C. Fixed Paper, .047 mfd, 400 W.V.D.C. Fixed Ceramic Disc, .02 mfd, 500 W.V.D.C. Fixed Silver Mica, 6 mmf, 500 W.V.D.C. Fixed Silver Mica, 27 mmf, 500 W.V.D.C. Fixed Ceramic Disc, .01 mfd, 500 W.V.D.C. Fixed Ceramic Disc, .1 mfd, 50 W.V.D.C. Fixed Silver Mica, 33 mmf, 500 W.V.D.C. Fixed Silver Mica, 50 mmf, 500 W.V.D.C. Fixed Silver Mica, 15 mmf, 500 W.V.D.C. Fixed Silver Mica, 2 mmf, 500 W.V.D.C. Fixed Silver Mica, 47 mmf, 300 W.V.D.C. Fixed Ceramic Disc, .005 mfd, 500 W.V.D.C. Fixed Silver Mica, 130 mmf, 500 W.V.D.C. Fixed Silver Mica, 5 mmf, 500 W.V.D.C. Fixed Silver Mica, 3 mmf, 500 W.V.D.C. Fixed Silver Mica, 7 mmf, 500 W.V.D.C. Fixed Silver Mica, 47 mmf, 500 W.V.D.C. Variable Mica, 3-35 mmf Fixed Silver Mica, 100 mmf, 500 W.V.D.C. Fixed Silver Mica, 100 mmf, 500 W.V.D.C. Fixed Ceramic Disc, 1000 mmf, 500 W.V.D.C. Fixed Paper, .1 mfd, 400 W.V.D.C. Fixed Paper, .1 mfd, 200 W.V.D.C. Variable Mica, 0.9-7 mmf Fixed Silver Mica, 5 mmf, 500 W.V.D.C.	K23006-10 K23045-2 K23034-27 K23006-63 K23006-64 M23034-28 M23034-29 K23006-65 K23006-66 K23006-68 K23006-37 K23006-47 K23034-31 K23006-70 K23006-78 K23006-42 K23006-24 K23006-71 K23043-1 K23006-72 K23006-1 M23034-30 K23045-1 K23045-3 K23043-2 K23006-5



## EXCITER PARTS LIST HX-500 (Cont'd)

SCHEMATIC DESIGNATION	DESCRIPTION	HAMMARLUND PART NO.
<b>COILS</b>		
L1, L3 L4, L5, L6, L7, L8, L9 L10 Z1	Coil, Adjustable, 60 Kcs Coil, Adjustable, 60 Kcs Inductor, Fixed, 112.5 Mh. Coil, Adjustable, 60 Kcs	K42167-2 M42167-1 K42411-1 M42167-3
<b>RESISTORS</b>		
R1, R21, R29, R30, R58 R2, R3 R4, R13, R19 R5, R6 R7, R11, R31, R40 R8 R9, R15, R20, R34, R37, R41, R46, R47 R10 R12 R14 R16, R54 R17, R18 R22 R23, R60 R24 R25 R26 R27 R28 R32, R51 R33, R36, R50 R35 R38 R39, R55 R42 R43, R53 R44 R45 R48 R49, R52, R62 R56 R57 R59 R61	100K ohms, 1/2 w., 10% 33K ohms, 1/2 w., 10% 1K ohms, 1/2 w., 10% 15K ohms, 1/2 w., 1% 47K ohms, 1/2 w., 10% 22K ohms, 1/2 w., 10% 1 Megohm, 1/2 w., 10%  100 ohms, 1/2 w., 10% 10K ohms, 1 w., 10% 2K ohms, 1/2 w., 1% 2.2K ohms, 1/2 w., 10% 62K ohms, 1/2 w., 5% 1 Megohm, 1/2 w., 5% 10 Megohms, 1/2 w., 10% 330 ohms, 1/2 w., 5% Variable, 200 ohms, (FSK-FM ADJUST.) 1.2 Megohms, 1/2 w., 5% 91K ohms, 2 w., 5% Variable, 50K ohms, (Calibrate Level) 4.7 Megohms, 1/2 w., 10% 220K ohms, 1/2 w., 10% 3.9K ohms, 1/2 w., 10% Variable, 1 Megohm, (Audio Level) 470 ohms, 1/2 w., 10% 5K ohms, 5 w., 10% Variable, 1 Megohm (VOX Sens.) (Anti-Trip Sens.) 1.5K ohms, 1/2 w., 10% 47K ohms, 1 w., 5% Variable, 5 Megohms, (VOX Delay) 470K ohms, 1/2 w., 10% 47K ohms, 2 w., 10% Variable, 100K ohms, (R.F. Level) Variable, 10K ohms, (Meter Sens.) 4.7K ohms, 1/2 w., 10%	K19309-97 K19309-85 K19309-49 K19338-1 K19309-89 K19309-81 K19309-121  K19309-25 K19310-73 K19338-5 K19309-57 K19309-183 K19309-297 K19309-145 K19309-37 K15380-6 K19309-298 K19304-137 K26218-6 K19309-137 K19309-105 K19309-63 K26218-7 K19309-41 K19339-1 K15380-2 K19309-53 K19310-295 K15380-5 K19309-113 K19304-58 K26218-8 K26218-9 K19309-65
<b>SWITCHES</b>		
SF-1A SF-1B SF-1C SF-1D SF-1E SO-2A SO-2B	Switch Wafer, Function Switch Wafer, Function Switch Wafer, Function Switch Wafer, Function Switch Wafer, Function Switch Wafer, Operations Switch, Power ON-OFF (Part of SO-2A)	K42340-1 K42341-1 K42341-2 K42341-3 K42341-4 K42342-1
<b>TRANSFORMERS</b>		
T1 T2 T3 T4	Transformer, 60 Kcs Modulator Transformer, 60 Kcs Bifilar Transformer, 1650 Kcs with Trap Transformer, 1650 Kcs	M42170-1 M42169-1 M42171-1 M42166-1
<b>MISCELLANEOUS</b>		
CR-1, CR-2 J1 J2 J3 J4 J5 J12 M1 Y1	Diodes, Germanium (1N634) Connector, Female (1650 Kcs output) Connector, Male (Power Conn.) Connector, Male (Mike) Jack (Key) Jack (Monitor) Jack (Patch) Meter, Carrier Level Crystal Unit, 1590 Kcs	K41206-1 K42123-1 K41116-2 K41118-1 K35608-2 K35608-1 K35608-6 K42409-1 K42345-1



## VFO PARTS LIST HX-500

SCHEMATIC DESIGNATION	DESCRIPTION	HAMMARLUND PART NO.
<b>CAPACITORS</b>		
C80, C87 C81, C95 C82, C83, C84, C94 C85 C86 C88, C96 C89, C90 C91 C92 C93	Fixed Silver Mica, 10 mmf, 500 W.V.D.C. Fixed Ceramic Disc, .1mfd, 50 W.V.D.C. Fixed Ceramic Disc, .01 mfd, 500 W.V.D.C. Fixed Silver Mica, 4 mmf, 500 W.V.D.C. Fixed Paper, .1 mfd, 400 W.V.D.C. Fixed Silver Mica, 62 mmf, 500 W.V.D.C. Fixed Silver Mica, 510 mmf, 500 W.V.D.C. Variable (VFO Tuning) Variable (VFO Trim) Fixed Temp. Comp, 23 mmf, 1000 W.V.D.C.	K23006-22 K23034-29 K23034-28 K23006-38 K23045-1 K23006-81 K23027-17 P20167-G1 K34452-G45 K23010-32
<b>COILS</b>		
L13, L14 L15 L16 L17 Z2	Inductor, Filament R.F. Choke, 1.0 millihenry R.F. Choke, 180 microhenries Coil Assembly, Adjustable, VFO Trap Coils, Bandpass	K42354-1 K15629-3 K15629-4 K42331-G1 M42327-1
<b>RESISTORS</b>		
R80 R81 R82, R83, R89 R84 R85 R86 R87 R88	1 Megohm, 1/2 w., 10% 330 ohms, 1/2 w., 10% 62K ohms, 1/2 w., 5% 1K ohms, 1/2 w., 10% 1K ohms, 1/2 w., 5% Variable, 200 ohms (Resistance Bal.) 1K ohms, 1/2 w., 1% 47K ohms, 1/2 w., 1%	K19309-121 K19309-37 K19309-183 K19309-49 K19309-267 K15380-1 K19338-3 K19338-4
<b>TRANSFORMERS</b>		
T6 T7 T8	Transformer, 1650 Kcs Transformer, Bifilar Bandpass Transformer, Bandpass	M42166-1 M42325-1 M42326-1
<b>MISCELLANEOUS</b>		
J6, J7 J8	Connector, Female Connector, Male	K42123-1 K41116-1

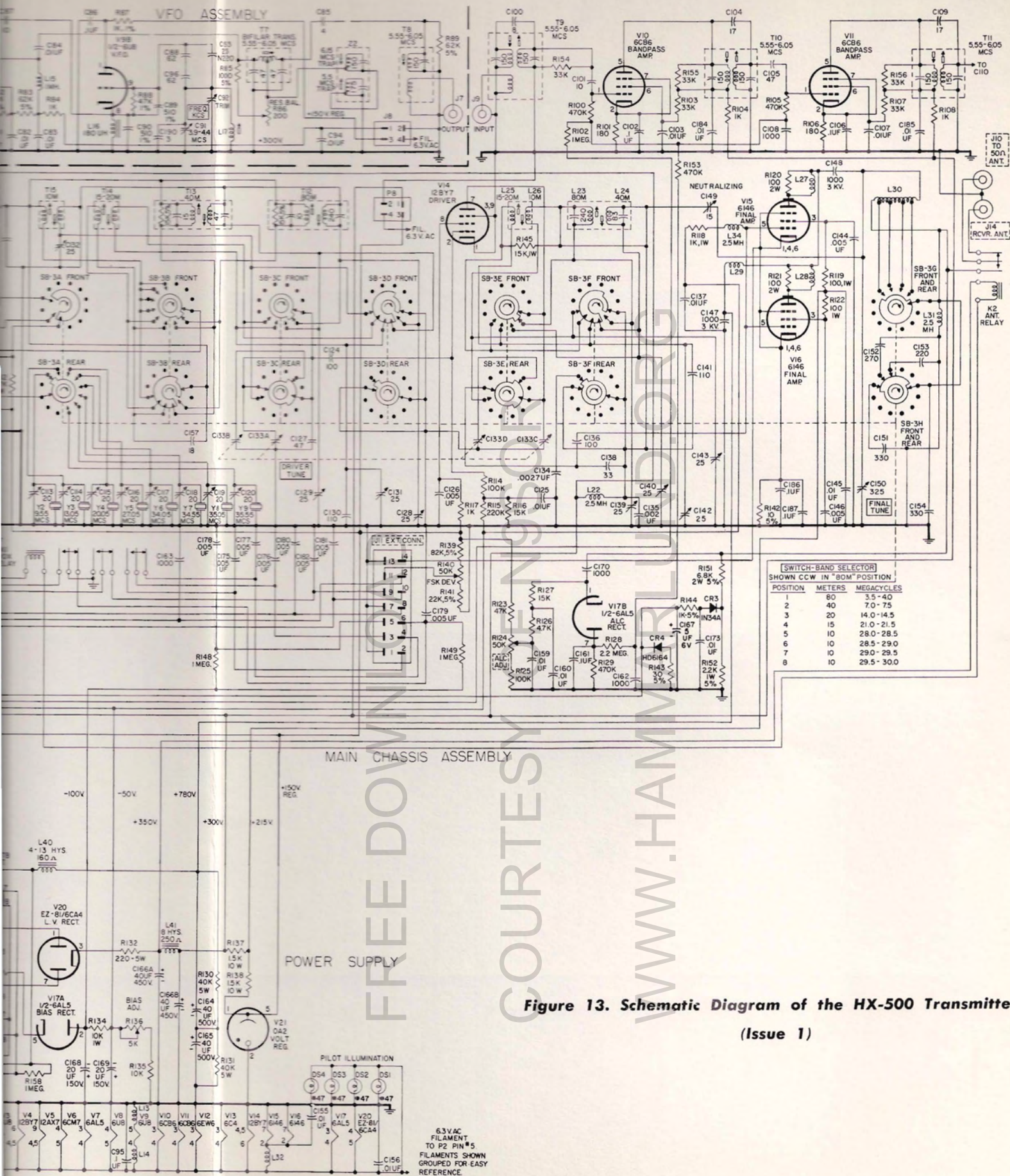
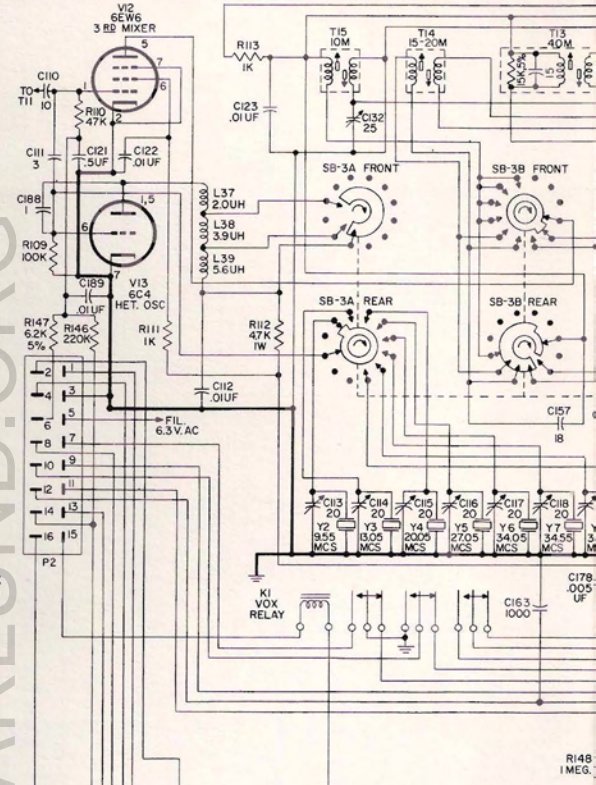
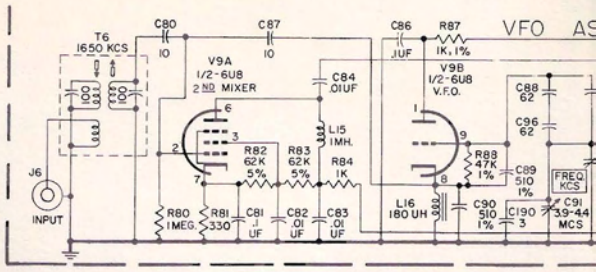
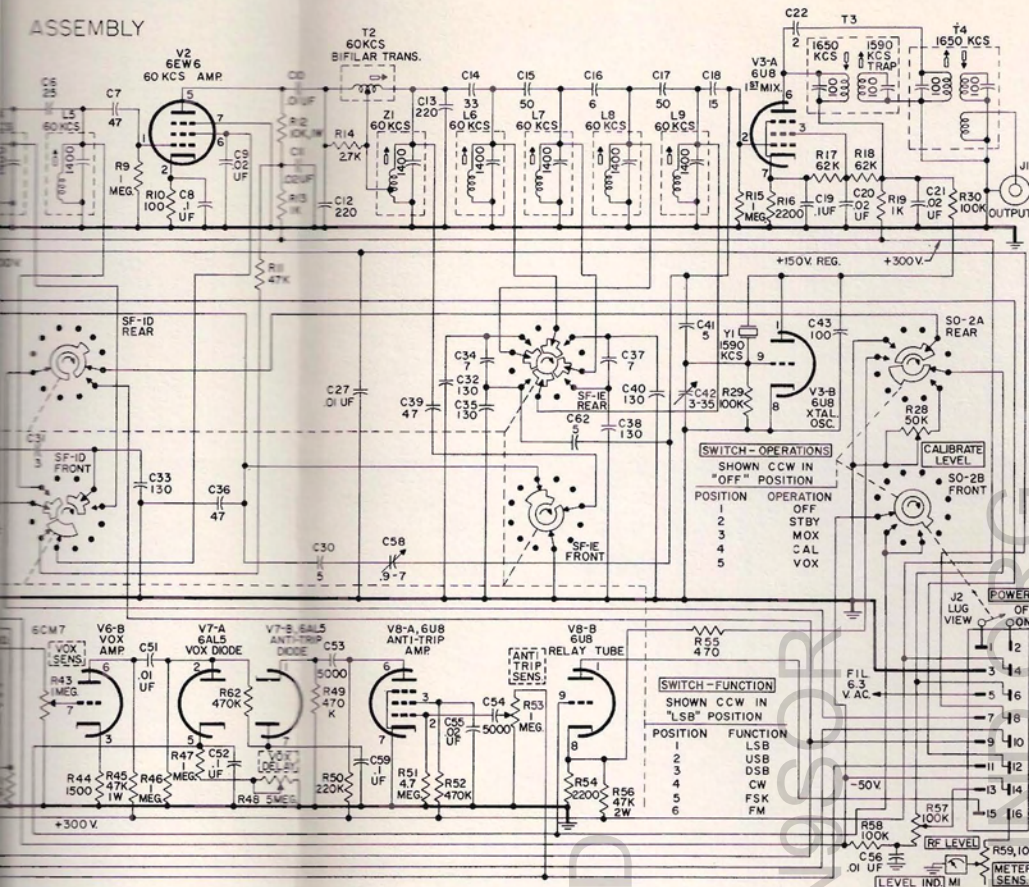

Figure 13. Schematic Diagram of the HX-500 Transmitter (Issue 1)

ASSEMBLY



**SWITCH-OPERATIONS**  
 SHOWN CCW IN "OFF" POSITION  
 POSITION OPERATION  
 1 OFF  
 2 STBY  
 3 MOX  
 4 CAL  
 5 VOX

**SWITCH-FUNCTION**  
 SHOWN CCW IN "LSB" POSITION  
 POSITION FUNCTION  
 1 LSB  
 2 USB  
 3 DSB  
 4 CW  
 5 FSK  
 6 FM

- NOTES: 1. ALL CAPACITORS IN MME UNLESS OTHERWISE INDICATED.  
 2. ALL RESISTORS 1/2 WATT UNLESS OTHERWISE INDICATED.  
 3. □ FRONT PANEL PRIMARY CONTROLS AND INPUTS  
 4. ◻ FRONT PANEL SECONDARY CONTROLS REAR APRON CONNECTIONS & ADJUSTMENTS  
 5. † ADJUSTMENT TOP OF CAN ‡ ADJUSTMENT BOTTOM OF CAN.  
 6. SLUGS ADJUSTED TOP OR BOTTOM WITH G.C. # 9295 TOOL OR EQUAL.  
 7. P2 AND J11 SHOWN LUG VIEW (SIDE TO WHICH WIRES ARE CONNECTED).

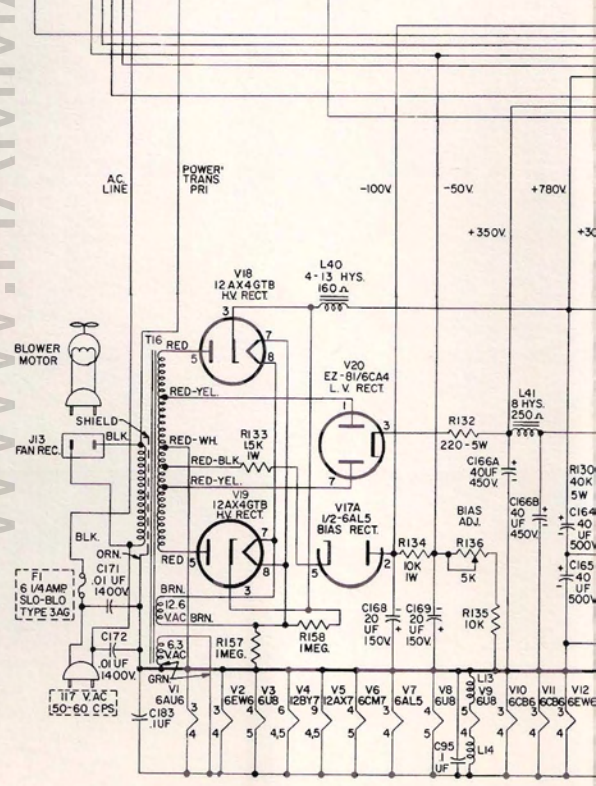

FREE DOWNLOAD  
 COURTESY OF N3GSO  
 WWW.HAMMARLIFE.COM

# EXCITER ASSEMBLY

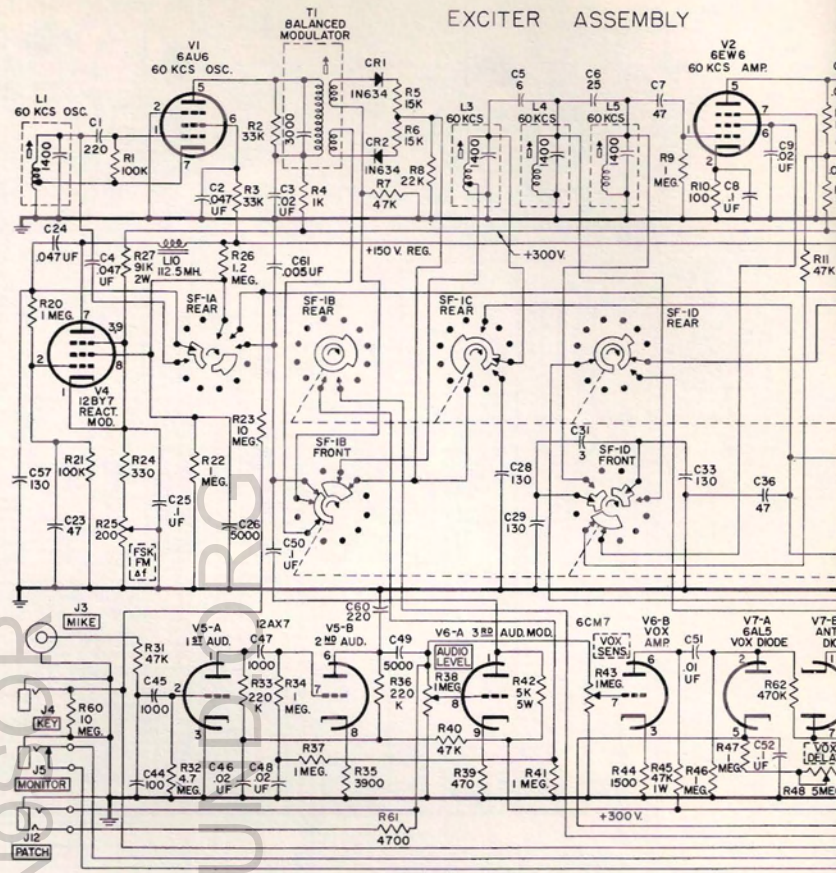

- NOTES: 1. ALL CAPACITORS IN MM  
 2. ALL RESISTORS 1/2 WAT  
 3. □ FRONT PANEL PR  
 4. □ FRONT PANEL SE  
 REAR APRON CONN  
 5. ↑ ADJUSTMENT TOP  
 SLUGS ADJUSTED  
 6. P2 AND J11 SHOWN LUG  
 7. WIRES ARE CONNECTED

FREE DOWNLOAD  
 COURTESY OF NOSCOP  
 WWW.HAMMARLU



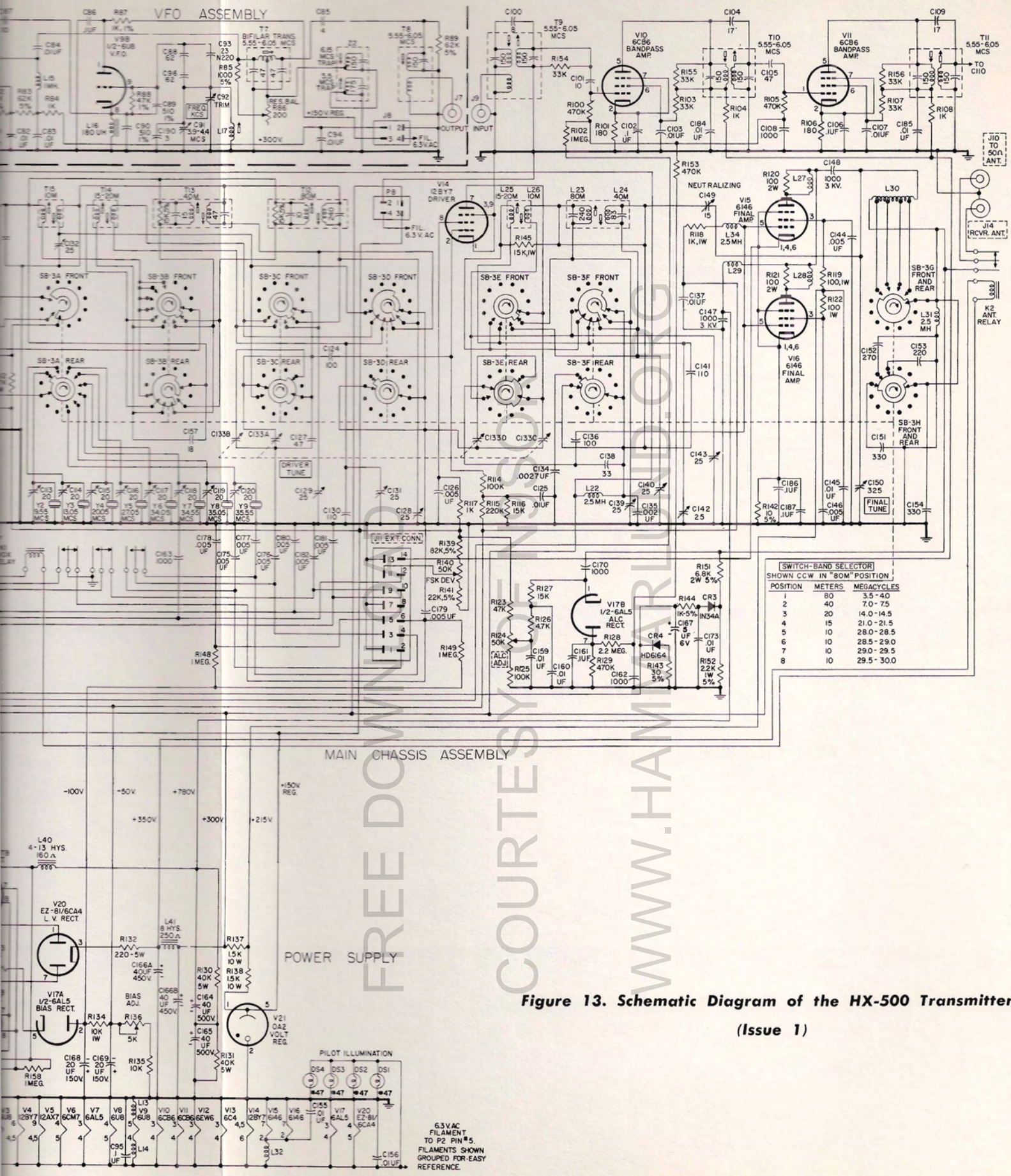
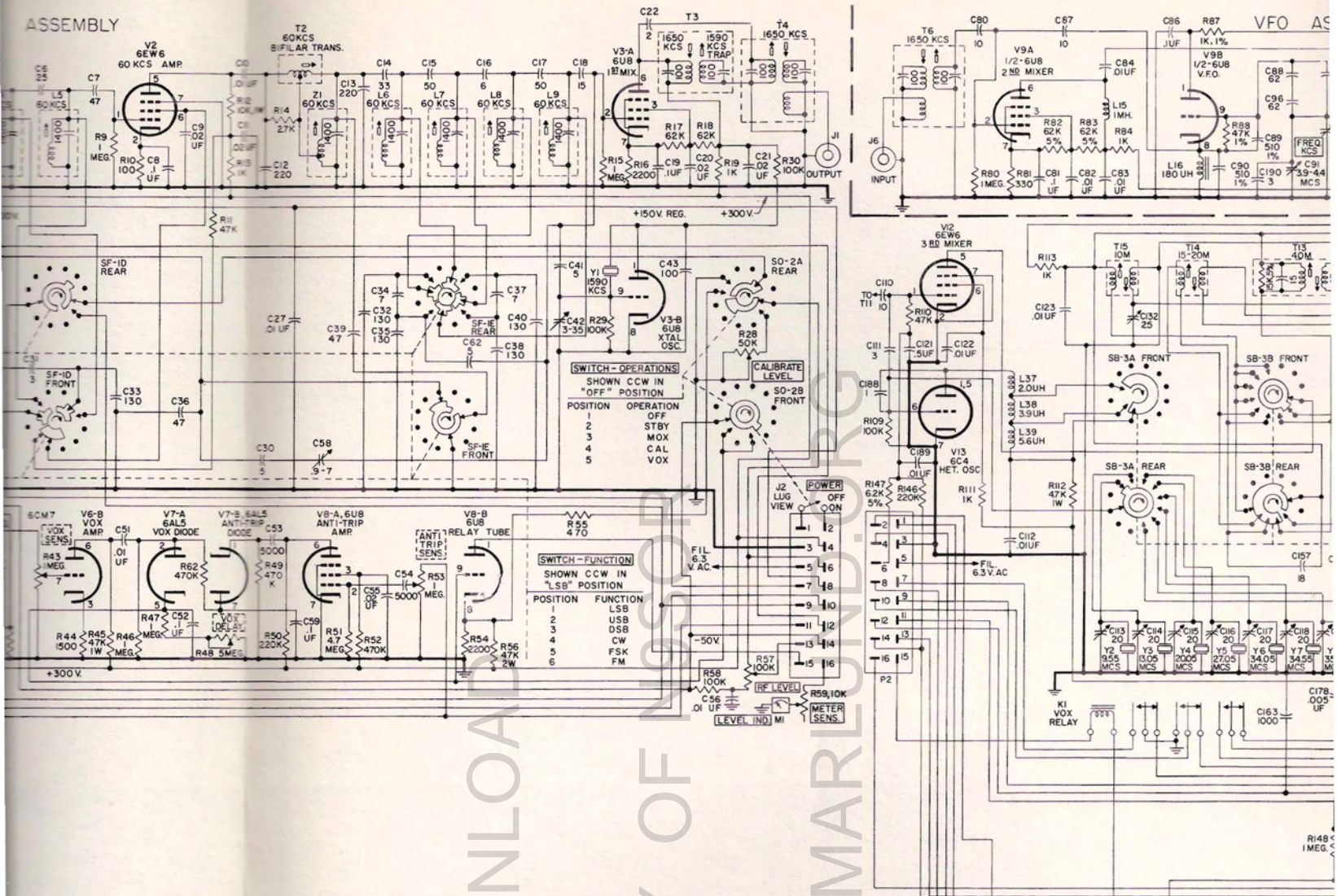

Figure 13. Schematic Diagram of the HX-500 Transmitter (Issue 1)

ASSEMBLY



**SWITCH-OPERATIONS**

SHOWN CW IN "OFF" POSITION

POSITION	OPERATION
1	OFF
2	STBY
3	MOX
4	CAL
5	VOX

**SWITCH-FUNCTION**

SHOWN CW IN "LSB" POSITION

POSITION	FUNCTION
1	LSB
2	USB
3	DSB
4	CW
5	FSK
6	FM

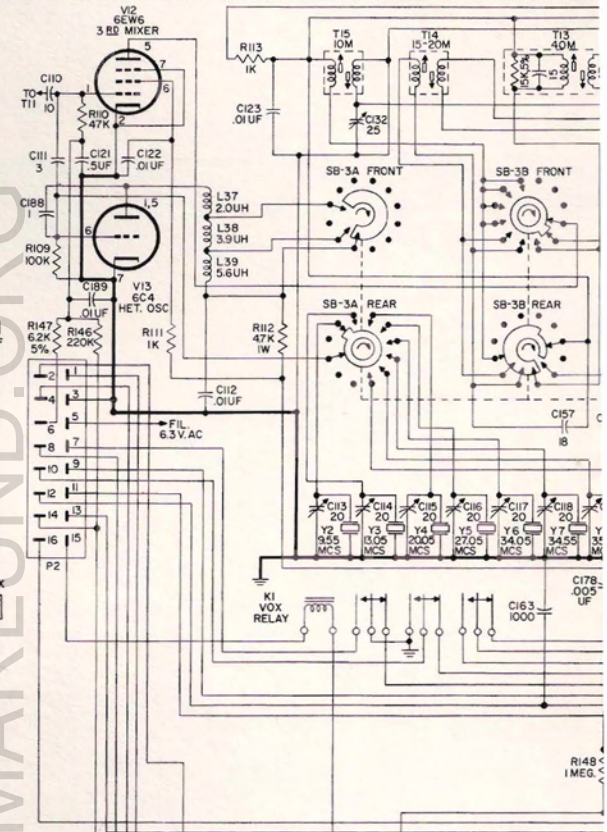
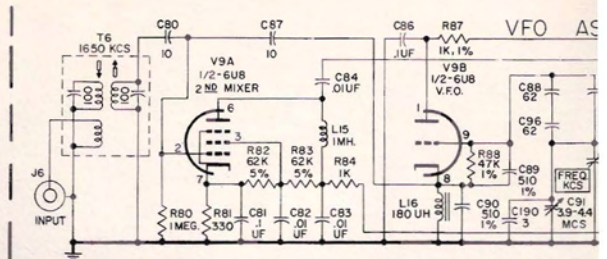

- NOTES: 1. ALL CAPACITORS IN MME UNLESS OTHERWISE INDICATED.  
 2. ALL RESISTORS 1/2 WATT UNLESS OTHERWISE INDICATED.  
 3. □ FRONT PANEL PRIMARY CONTROLS AND INPUTS  
 4. □ FRONT PANEL SECONDARY CONTROLS REAR APRON CONNECTIONS & ADJUSTMENTS.  
 5. † ADJUSTMENT TOP OF CAN. ‡ ADJUSTMENT BOTTOM OF CAN.  
 6. SLUGS ADJUSTED TOP OR BOTTOM WITH G.C. # 9295 TOOL OR EQUAL.  
 7. P2 AND J11 SHOWN LUG VIEW (SIDE TO WHICH WIRES ARE CONNECTED).

FREE DOWNLOAD  
 COURTESY OF  
 WWW.HAMMARL...

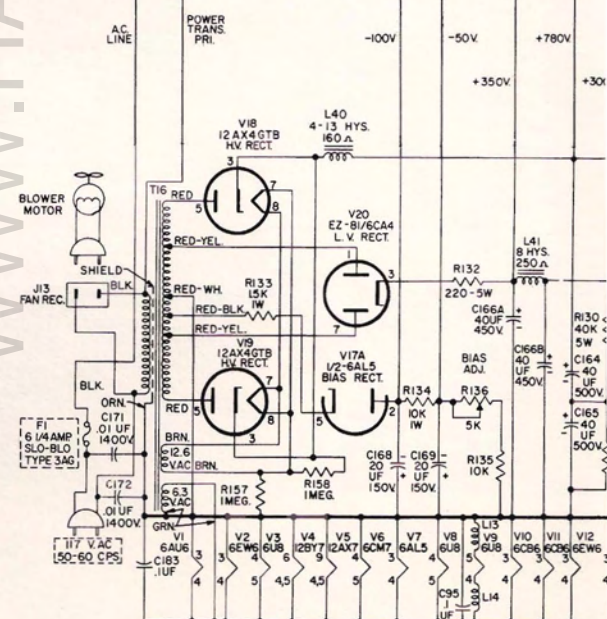

EXCITER ASSEMBLY

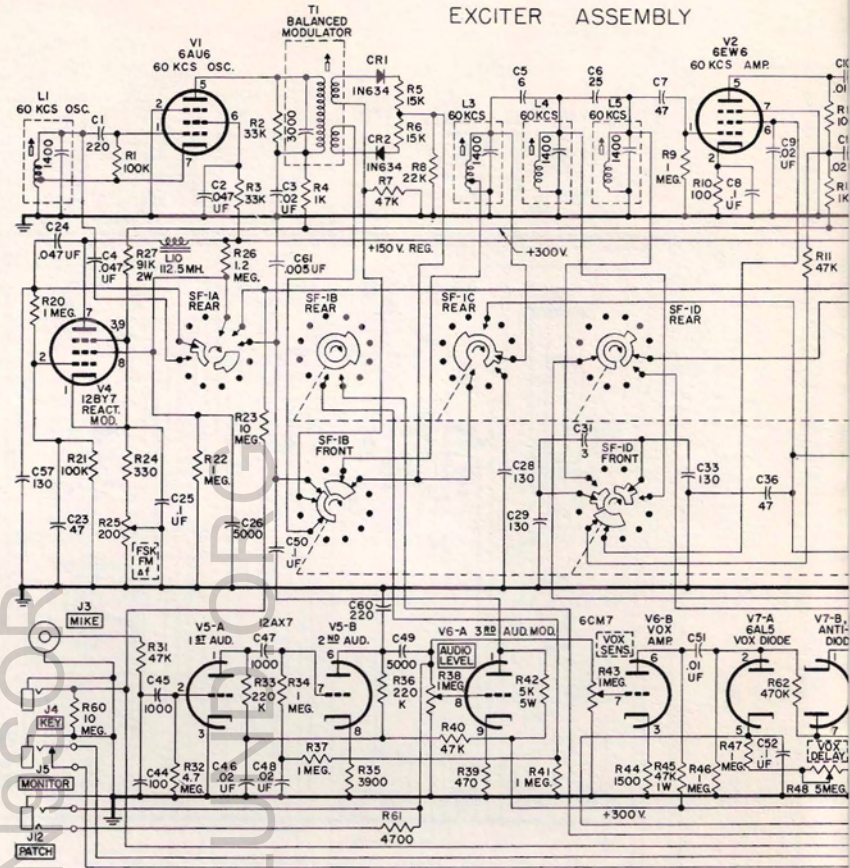

- NOTES: 1. ALL CAPACITORS IN MM  
 2. ALL RESISTORS 1/2 WAT  
 3. □ FRONT PANEL PRI  
 4. □ FRONT PANEL SEC  
 REAR APRON CONNE  
 5. † ADJUSTMENT TOP  
 6. SLUGS ADJUSTED  
 7. P2 AND J11 SHOWN LUG V  
 WIRES ARE CONNECTED.

FREE DOWNLOAD

COURTESY OF

WWW.HAMMARL

THE HAMMARLUND MANUFACTURING COMPANY, INC.

Standard Warranty

The Hammarlund Manufacturing Company, Inc., warrants this equipment to be free from defects in workmanship and materials under normal and proper use and service for the uses and purposes for which it is designed, and agrees to repair or replace, without charge, all parts thereof showing such defects which are returned for inspection to the Company's factory, transportation prepaid, within a period of 90 days from date of delivery, provided such inspection discloses to the satisfaction of the Company that the defects are as claimed, and provided also, that the equipment has not been altered, repaired, subjected to misuse, negligence or accident, or damaged by lightning, excessive current or otherwise, or had its serial number or any part thereof altered, defaced, or removed. Tubes shall be deemed to be covered by the manufacturer's standard warranty applicable thereto, and such items shall be and are hereby excluded from the provisions of this warranty. Pilot lamps and fuses are not guaranteed for length of service.

Except as herein specifically provided, no warranty, express or implied, other than that of title, shall apply to any equipment sold hereunder. In no event shall the Company be liable for damages by reason of the failure of the equipment to function properly or for any consequential damages.

This Warranty is valid for the original owner of the equipment, and is contingent upon receipt of the Warranty Registration Card by the Company. No equipment shall be returned to the factory for repairs under warranty unless written authorization is obtained by the Company, and the equipment is shipped prepaid by the owner. The Company maintains Authorized Service Stations, names and locations of which will be sent upon request of the owner.

The Hammarlund Manufacturing Company, Inc.  
460 West 34th Street  
New York 1, N.Y.



