



SEA 235 OPERATOR'S MANUAL

Digital Single Sideband Radiotelephone

SEA®
A UNIT OF DATAMARINE INTERNATIONAL INC.

TABLE OF CONTENTS

GENERAL OPERATIONS	1
TECHNICAL SPECIFICATIONS	1
GENERAL INFORMATION	2
UNDERSTANDING CHANNEL MEMORY	3
LCD DISPLAY CHARACTERS	4
FRONT PANEL CONTROLS	4
BASIC OPERATION	5
TURNING THE RADIO ON	6
OPERATING THE TRANSMITTER	6
THE TUNED INDICATOR	6
DEMAND TUNE	7
NOISE BLANKER OPERATION	7
SELECTING A VOICE CHANNEL	8
SELECTING A TELEX CHANNEL	8
SELECTING A CHANNEL BY BIN NUMBER	9
CHANGING THE DISPLAY VIEW	9
ENTERING A RECEIVE ONLY FREQUENCY	10
SELECTING THE EMERGENCY CHANNEL	10
SENDING THE DISTRESS ALARM SIGNAL	11
OVERRIDE	12
SQUELCH OPERATION	12
CLARIFIER OPERATIONS	12
OPERATING THE MEMORY BROWSE	13
ADVANCED OPERATIONS	14
SELECTING THE PROGRAM MENU	14
STORING THE DISPLAYED FREQUENCY	17
PROGRAMMING A NEW FREQUENCY	19
ERASING A CHANNEL	22
CHANGING THE NAME TAG OF A BIN	23
SCANNING A CHANNEL GROUP	24
DIRECT FREQUENCY	25
INTERCOM	26
FUNCTION MENUS	27
FUNCTION MENU OVERVIEW	27
FINDING A BIN WITH THE ALPHA MENU	28
CHANGING THE MODE WITH THE MODE MENU	29
SELECTING THE TRANSMIT POWER LEVEL	31
CHANGING THE DISPLAY ILLUMINATION	33
CHANGING THE SQUELCH THRESHOLD	35

TABLE OF CONTENTS

SETUP MENU OPTIONS	36
CHANGING THE KEY BEEP SETTING	39
CHANGING THE TUNER STATUS	40
CHANGING THE CONTROLLER UNIT NUMBER	41
CHANGING THE SSB AUDIO INPUT SOURCE	41
CHANGING THE TELEX AUDIO INPUT SOURCE	43
CHANGING THE SSB AGC CHARACTERISTICS	44
CHANGING THE TELEX AGC CHARACTERISTICS	45
CHANGING THE VOGAD CHARACTERISTICS	46
AMATEUR OPERATING SYSTEM	47
THE RADIO AMATEUR OPERATING SYSTEM	47
FREQUENCY LISTINGS	49
SEA 235 VOICE FREQUENCY LISTING	49
DSC EMERGENCY CALLING FREQUENCIES	60
SEA 235 TELEX FREQUENCY LISTING	61
COAST STATIONS PROVIDING TELEX SERVICE	84
SEA SCRATCH PAD MEMORY LISTING	85
SEA SCRATCH PAD WORKSHEET	91
SSB PROPAGATION TABLES	93
REAR PANEL	95
REAR PANEL CONNECTIONS	95
GLOSSARY	97

LIST OF FIGURES

<i>Key Chart 1 - PROGRAM MENU 1</i>	<i>15</i>
<i>Key Chart 2 - PROGRAM MENU 2</i>	<i>16</i>
<i>Key Chart 3 - MODE MENU</i>	<i>30</i>
<i>Key Chart 4 - POWER MENU</i>	<i>32</i>
<i>Key Chart 5 - DIMMER MENU</i>	<i>34</i>
<i>Key Chart 6 - SETUP MENU 1</i>	<i>37</i>
<i>Key Chart 7 - SETUP MENU 2</i>	<i>38</i>

TECHNICAL SPECIFICATIONS**DIMENSIONS:**

3.9" H x 10.5" W x 10.9" D
 99mm H x 265mm W x 278mm D

WEIGHT:

10 Lbs.
 4.5 Kgs.

ELECTRICAL:

Type Acceptance	FCC Parts 80, 87, 90
FCC Identifier	BZ6SEA235
Frequency Range	(TX) 1.605 - 29.999 MHz (RX) 0.490 - 29.999 MHz
Operating Temperature	-30 degrees to +60 degrees C
Frequency Stability	± 10 Hz
Operating Modes	J3E, R3E, H3E (2182 KHz) A1A (CW), F2B (TELEX)
Primary Voltage	13.6 V DC ± 15% (11.6 - 15.6 V DC) Negative Rail Common to Chassis
Current Drain	Receive Standby 1 Amp Receive Full Audio 1.5 Amps Transmit Voice 11 Amps Transmit Two-Tone 17 Amps Transmit TELEX 22 Amps
Output Impedance	50 ohms
Transmitter Output Power	R3E, J3E 150 Watts PEP F2B 150 Watts LOW 50 - 75 Watts VLOW 25 - 40 Watts
Receiver Sensitivity	≤ 1 μV for 12 dB SINAD
Audio Output	4 W @ ≤ 10% distortion into external 4 ohm load.

GENERAL OPERATIONS

GENERAL INFORMATION

CAUTION !

Do not attempt to transmit until the radiotelephone has warmed up for at least 3 minutes. Transmitting before the 3 minute warm up period can cause a violation of the Federal Communications Commission regulations.

PROPAGATION

Medium Frequencies (MF) in the range of 300 KHz to 3 MHz propagate far beyond the horizon. MF frequencies are generally usable within 300 miles depending on the time of day, atmospheric conditions and man-made noise levels.

High Frequencies (HF) in the range of 3 MHz to 30 MHz allow communications over thousands of miles, again subject to the time of day and atmospheric conditions. Interference tends to be more of a problem than on Very High Frequencies (VHF) in the range of 30 MHz to 300 MHz.

To further understand MF/HF propagation, SEA's "Mariners Guide to Single Sideband" (MAN-0001-001) is highly recommended reading.

INSTALLATION (RF grounding & DC connections)

A radio frequency (RF) ground with a minimum of 100 sq. ft. is required for proper operation. This ground system is not unique to SEA equipment. All marine MF/HF radios have the same installation requirements for maximum efficiency. Every connection to the ground should be made with a minimum of 2" wide copper strap. Proper wire size must be used between the radio and power supply to prevent the DC (direct current) voltage at the radio from dropping below 11.5 volts during transmit conditions. Should this occur, the radio will drop to low power during transmit to prevent distorted transmissions. It is recommended that an authorized SEA dealer perform the installation of your MF/HF equipment to assure proper operation. For complete installation instructions, refer to the "SEA 235 Installation Manual" (OPR-235-INST) supplied with the radio.

RADIO PROTECTION

The SEA 235 monitors radio conditions such as DC supply voltage, internal temperature and antenna VSWR. When these conditions are outside the preset limits, the radio will revert to low power (approximately 75 Watts). The display's LOW indicator will light to indicate this condition. If this should occur during an EMERGENCY situation, pressing **6** **6** **FNC** will override the monitoring sensors and allow FULL output power. The radio will stay in the EMERGENCY OVERRIDE condition until the radio power is recycled.

UNDERSTANDING CHANNEL MEMORY**CHANNELS**

Nearly 1000 frequency pairs are stored as permanent channels in the SEA 235. These channels are recalled by their assigned ITU or SEA channel number. ITU numbers are known internationally and include all duplex frequency pairs starting at 4 MHz and ending with 25 MHz. SEA numbers are assigned to those frequencies that do not have an assigned ITU number. Currently all 2 to 3 MHz frequencies and all simplex frequencies are assigned SEA channel numbers.

It is important to note that not all radios use the same channel numbers for simplex or 2 to 3 MHz frequencies. Some radios use an “A”, “B”, “C” channel assignment for frequencies not assigned an ITU channel number. For example, if you refer to the SEA simplex channel 451 during communications, the person you are communicating with may not have a channel 451. Their radio may have the same frequency (4146.0 KHz) assigned to channel “4A”. For reliable communications, always refer to the frequency when referencing simplex channels or frequencies below 4 MHz.

BINS

In addition to the permanent memory, 200 user programmable channels known as bins have been assigned for “scratchpad” memory. Approximately 170 of these 200 channels have been programmed by SEA but may be changed at any time. Bins may be programmed with any frequency, mode of transmission and given a name tag besides a bin number.

SCAN CELLS

Consecutive bin numbers that have the same first three characters in their name tag, are known as “scan cells”. SEA has programmed 170 of the 200 possible bins into 23 different scan cells. Scan cells may be as short as one bin or as long as 200 bins but should be kept to a reasonable length for scanning efficiency. Each scan cell is organized with frequency pairs that are related to one another. For example, bins 13 through 30 have been programmed with frequencies assigned to the coast station KMI. Since the name tag’s first three characters are “KMI”, and the bins are consecutively numbered, the bins may be scanned as a group. If the bins do not have the same first three characters, the scan cell will be split into two different cells. For instance, if bin 20 is renamed to “SEA 1”, the KMI scan cell will be split into two cells. One cell will contain bins 13 through 19, while the other cell will contain bins 21 through 30. Bin 20 will be a single channel scan cell called “SEA”. Scanning “KMI” could be done by scanning bins 13 through 19 **OR** bins 21 through 30 but not both at the same time.

Care should be given that a scan cell is not split unintentionally. Bins that will not be scanned can be given any descriptive name tag.

GENERAL OPERATIONS

LCD DISPLAY CHARACTERS



Alphanumeric digits display channel numbers, frequencies and menus.

NB

The NOISE BLANKER is activated.

TX

The radio is in TRANSMIT.

TND

The attached coupler has finished the tune process.

LOW

Indicates 1/2 output power during transmit when on steady or 1/4 output power when flashing.

AME

The radio will transmit a reduced carrier (H3E) of approximately 40W. This mode is only available on the emergency frequency 2182.0 KHz.

LSB

Both transmit and receive will use LOWER SIDEBAND mode.

TLX

TELEX (J2B) mode will be used for transmit and receive.

SQL

The receiver SQUELCH is activated.



Relative output power when transmitting and audio signal strength during receive. No bars indicates weak signal.

FRONT PANEL CONTROLS

PWR

Toggles power on/off.

0 - 9

Used to enter channel/frequency information and menu selections.  used alone, recalls emergency frequency 2182.0 KHz.

ALRM

Toggles alarm generator test on/off.

**NB
SEND**

Enables receiver noise blanker. When used with **ALRM**, transmits alarm signal.

SQL

Toggles squelch on/off.

**CH
FX**

Toggles display to show channel / bin #, frequency, or alpha name.

FNC

Accesses function menus and other function commands.

ENT

Selects displayed function menu or completes keyed entry.



Increases receiver frequency and scrolls selected function options.



Decreases receiver frequency and scrolls selected function options.

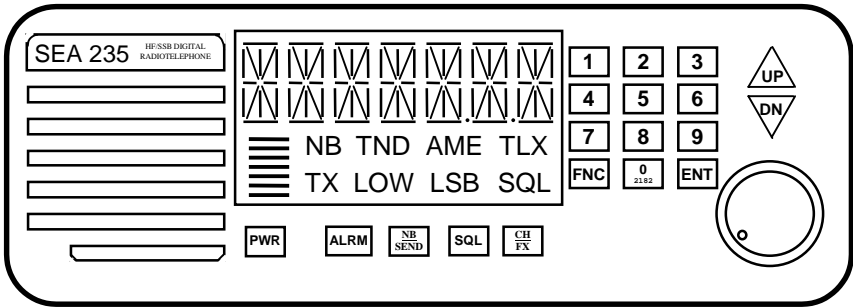

BASIC OPERATION

To turn the radio on, press **PWR**

Wait 3 minutes for the synthesizer frequency to stabilize before transmitting.

Rotate the volume control clockwise to increase the volume level.

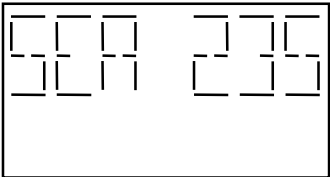

Press **SQL** to activate the squelch.

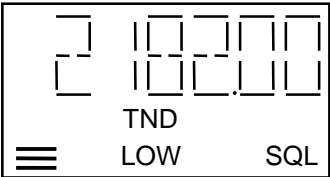

Enter the desired channel number in three or four digit form, followed by the **ENT** key.

e.g. **4** **5** **1** **ENT**

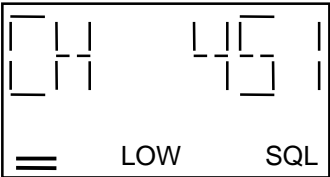

The display will show the channel number for 2 seconds then change to display the receive frequency.

Your SEA 235 is now set to transmit and receive on the selected channel.

For instructions on enabling other radio functions, see the table of contents for the page number corresponding to the specific function.

Illustrations in this manual reflect the use of an attached SEA 1635 tuner. Differences in tuner choice or radio programming may produce varying displays.

GENERAL OPERATIONS

TURNING THE RADIO ON

Press **PWR**

All display segments will be shown for a short period followed by the radio model number, then the controller (CT) and transceiver (RT) software versions. The radio will then be set to the MARINE mode on international emergency frequency 2182.0 KHz using USB, J3E mode.

Wait 3 minutes for the synthesizer frequency to stabilize before transmitting.

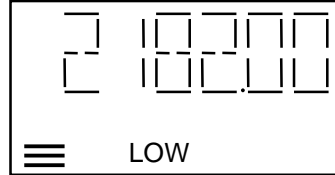
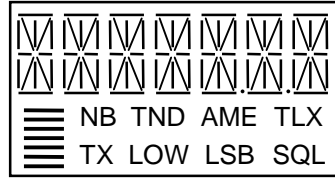

OPERATING THE TRANSMITTER

Keying the microphone push-to-talk button will switch the transmitter circuits on, indicated by the “TX” indicator appearing on the display. Speak in a normal voice with your lips about one eighth of an inch away from the microphone. Do not shout. Shouting reduces intelligibility. The number of bars displayed will change as the operator talks.

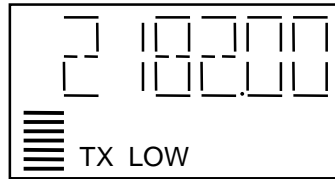

THE TUNED INDICATOR

The display’s “TND” indicator shows that the SEA 1612 series, SEA 1635 or SEA 1631 antenna tuner has successfully matched the antenna to the radio for maximum radiated power. When the radio tuner mode is enabled, entering a frequency or channel will cause the “TND” indicator to extinguish and the “LOW” indicator to appear. Speaking into the microphone when the PTT is pushed will allow the tuner to find a match. The “TND” indicator will be displayed and the “LOW” indicator will extinguish allowing full output power.

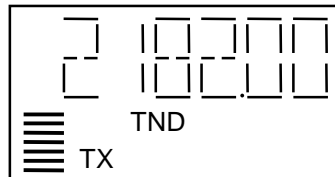
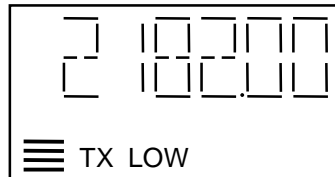

NOTE: *If a frequency or channel has never been used, the “match” will take slightly longer.*

DEMAND TUNE

When the tuner senses a high VSWR, it will attempt to match the antenna automatically during transmit. The Demand Tune function signals the tuner to undergo a complete tune cycle even with an acceptable VSWR. This may be needed on those rare occasions when the “TND” indicator does not appear or when the operator suspects the match could be better. For the Demand Tune function to operate, the SEA 1612C or SEA 1635 tuner must have the ‘DTN’ terminal connected to the SEA 235’s rear panel accessory connector P3 pin 10 (DMD TUNE). The ‘TUNER’ option in the radio’s “SETUP” menu must also be programmed to “TNR ON”. Better tunes may occur using Demand Tune.

To Demand Tune, key the radio by holding the PTT button on the microphone down, then press and release **FNC** to start the tune cycle.

The “TND” indicator will turn off, the “LOW” indicator will turn on and the radio will show “TUNING”.

When the tuner has successfully completed the match, the “LOW” indicator will disappear as the “TND” indicator appears and the display will show the VSWR. Release the microphone PTT.

In the event that the tuner can not find a match in 15 seconds, the radio will stop transmitting and the display will read “NO TUNE”.

When tuning with voice, “HI VSWR” will occasionally be displayed until the tune cycle has successfully completed the antenna match.

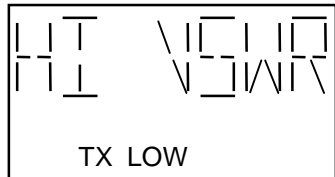
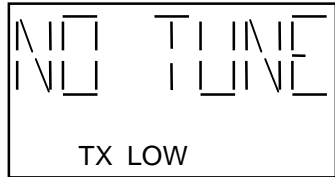

NOISE BLANKER OPERATION

Use the **NB SEND** key to toggle the noise blanker on / off. The “NB” indicator shows the noise blanker is on. The noise blanker will help reduce impulse noise that may be caused by on board equipment such as a bilge pump or refrigerator compressor.

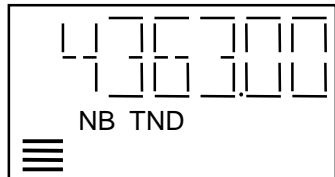

GENERAL OPERATIONS

SELECTING A VOICE CHANNEL

Enter the desired three or four digit ITU/SEA channel number followed by **ENT**

e.g. **4** **0**₂₁₈₂ **3** **ENT**

The display will show the channel entered followed by the receive frequency for the selected channel.

Press **CH**/**FX** to switch between the channel number display and the frequency display.

When the microphone PTT button is pressed, the transmit frequency will be displayed when in frequency display mode.

If the channel does not exist, "NO FREQ" is displayed.

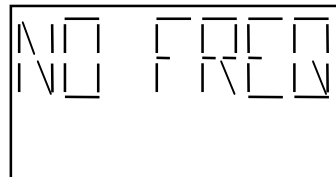
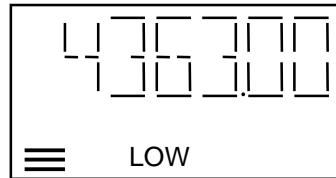
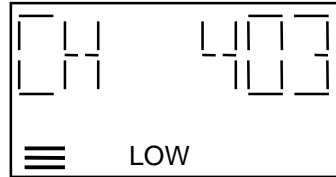

SELECTING A TELEX CHANNEL

The SEA 235 is capable of telex operations when used with an appropriate modem.

Enter the desired three or four digit ITU/SEA telex channel number followed by **CH**/**FX**

e.g. **4** **0**₂₁₈₂ **3** **CH**/**FX**

The display will show the channel entered followed by the receive frequency for the selected channel.

Press **CH**/**FX** to switch between the channel number display and the frequency display.

When the microphone PTT button is pressed, the transmit frequency will be displayed when in frequency display mode.

If the channel does not exist, "NO FREQ" is displayed.

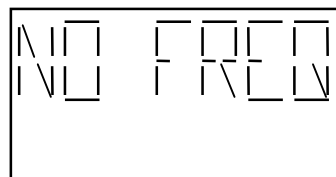
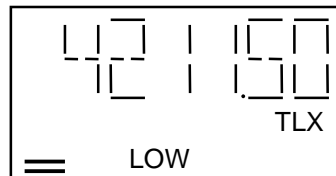
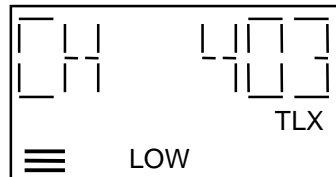

SELECTING A CHANNEL BY BIN NUMBER

Enter the desired one, two or three digit bin number followed by **ENT**

e.g. **2** **4** **ENT**

The display will show “BIN 24” for 1 second followed by the name tag of the bin selected.

Press **CH FX** to cycle between the channel display, frequency display, and alphanumeric name tag displays.

When the microphone Push To Talk button is pressed, the transmit frequency will be displayed when in frequency display mode.

If the bin is not programmed, “NO FREQ” is displayed.

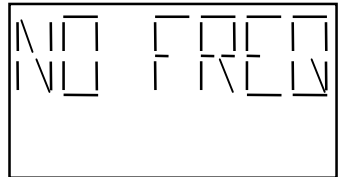
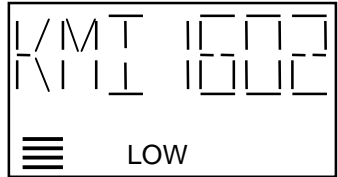
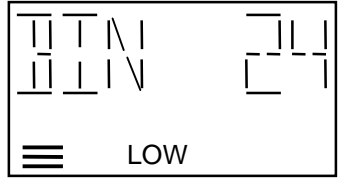

CHANGING THE DISPLAY VIEW

CH FX is used to change the display view between the alphanumeric name tag, channel number and the associated frequency for that channel.

For Bins, the **CH FX** key will change the display view between the Alphanumeric name tag, frequency and bin number.

When **CH FX** is pressed while on 2182.0 KHZ, the display will briefly show “EMER 0”.

To display the transmit frequency, press **CH FX** to have the display show the receive frequency. Press the microphone PTT to have the transmitter frequency displayed.

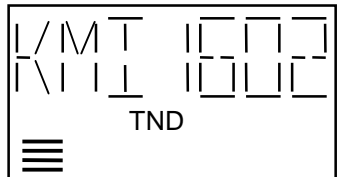

ALPHANUMERIC NAME TAG

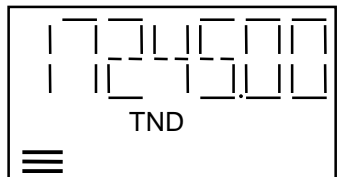

FREQUENCY VIEW

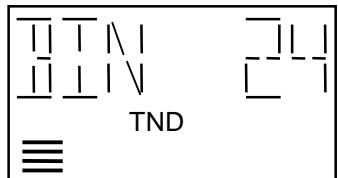

BIN / CHANNEL VIEW

GENERAL OPERATIONS

ENTERING A RECEIVE ONLY FREQUENCY

Enter any frequency using four, five, or six digits followed by “ENT”.

e.g.     

If the frequency entered is less than 490.0 KHz or greater than 29999.99 KHz, the radio will prompt “ILLEGAL” and revert to the last channel entered.

When trying to transmit on a receive only frequency, the display will show “RX ONLY”.

 will not operate in receive only mode.

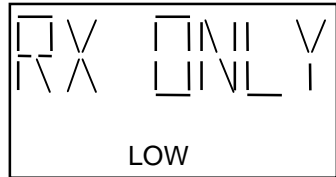
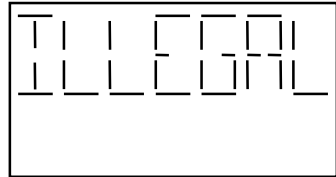
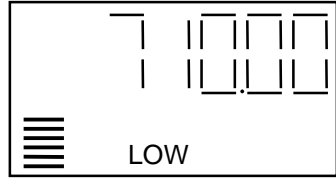



SELECTING THE EMERGENCY CHANNEL

Press 

The radio will switch to the international emergency frequency of 2182.0 KHz using USB, J3E mode.

If H3E (AME) mode is required, press  repeatedly until “MODE” is displayed.

Press  then  or 

(“PRESS+”) repeatedly until “AME” appears.

Press 

The radio is now ready to transmit an AME signal using a 40 W carrier.

Pressing the  will briefly show the assigned channel number, “EMER 0”.

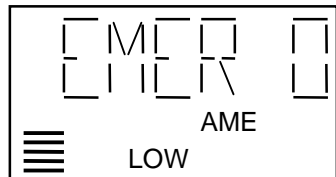
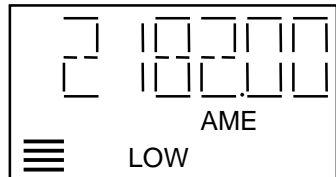
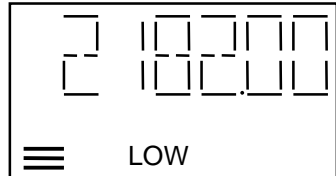

SENDING THE DISTRESS ALARM SIGNAL

Press **ENT** to stop any entry in progress.

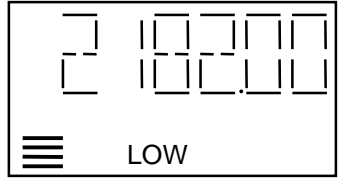

Press **0** **2182** to select 2182.0 KHz.

If H3E (AME) mode is required, press **FNC** repeatedly until "MODE" is displayed.

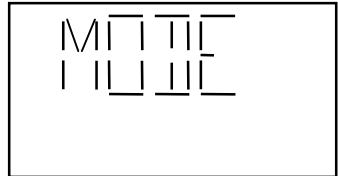

Press **ENT** then the **UP** or **DN** key repeatedly until "AME" appears.

Press **ENT** to select AME mode.

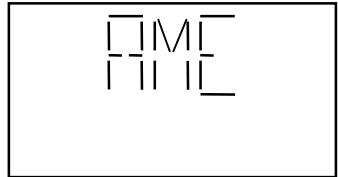

AME is only available on 2182.0 KHz.

To transmit the alarm signal, hold the **ALRM** key down then press **NB SEND**

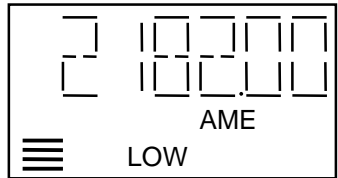

The radio will transmit the alarm for 45 seconds unless stopped by pressing **ALRM**

The two tone alarm signal can be transmitted on all available frequencies. It is not necessary to use 2182.0 KHz for the alarm generator to function.

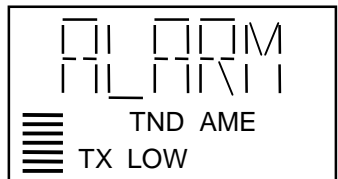

To test the alarm without transmitting a signal, press **ALRM**

You will hear the alarm tones through the speaker but no signal will be transmitted. This will continue for 45 seconds unless stopped by again pressing **ALRM**

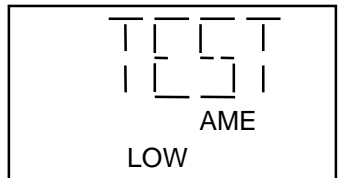

GENERAL OPERATIONS

OVERRIDE

When operating conditions are outside the normal preset limits, the radio will revert to low power (approximately 75 Watts). The display's "LOW" indicator will light to indicate this condition. If this should occur during an EMERGENCY situation, pressing **6** **6** **FNC** will override the monitoring sensors and allow FULL output power. The radio will stay in the EMERGENCY OVERRIDE condition until the radio power is re-cycled. If the power has been reduced manually or the tuner fails to match the antenna, the override will not increase to full power.

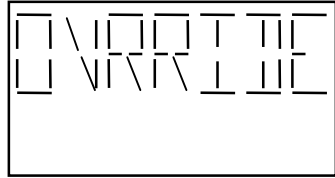

SQUELCH OPERATION

Use the **SQL** key to toggle the squelch on / off. The "SQL" indicator shows the squelch is on. The speaker will mute after approximately 2 seconds. Varying audio frequencies will open the squelch but not a steady tone.

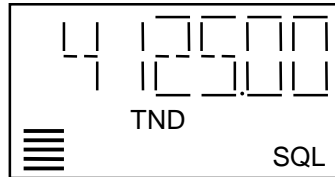



CLARIFIER OPERATIONS

In the "MARINE" operating system, the clarifier tuning range is limited to ± 200 Hz when used on any Bin or ITU/SEA channel. When the radio is turned on, the clarifier step size will default to 10 Hz.

Any "receive only" frequency or any frequency used in the "AMATEUR" operating system has an unlimited clarifier range and can be changed in steps of 10 Hz, 100 Hz, 1 KHz, or 10 KHz.

To change the clarifier resolution:

Select "1" for 10 Hz steps, "2" for 100 Hz steps, "3" for 1 KHz steps or "4" for 10 KHz steps then "UP" or "DN".

e.g. Press **2**  or  to have the clarifier change in 100 Hz steps.

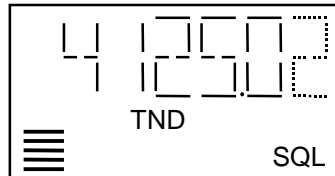

Flashing clarifier set for 10 Hz (default)

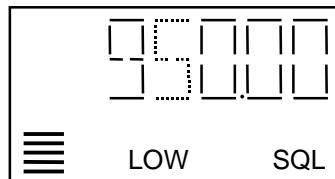

Flashing clarifier set for 10 KHz

The chosen clarifier digit will blink for 2 seconds to indicate the selection. If the digit does not blink, it is not a valid selection for the current mode and the setting will not change.

OPERATING THE MEMORY BROWSE

Browse enables a manual scan of all channels or bins programmed in the radio.

Press **9** then **UP** or **DN**

Pressing **UP** will change the channel to the next channel in memory. The display will then change to frequency mode when an ITU/SEA channel is selected.

Pressing **DN** will change the channel to the previous channel in memory. The display will then change to frequency mode when an ITU/SEA channel is selected.

CH/**FX** will toggle between bin/channel, frequency and name tag display modes.

Memory browse will not scan through bins and channels at the same time. If a channel is selected and you wish to browse the bins, select a bin number from which to start.

When the last bin or channel is selected, the next step will go to the beginning of the bin or channel list.

To exit memory browse, press the microphone Push To Talk button briefly, adjust the clarifier step size or recycle the radio power.

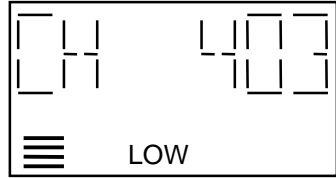

Starting at ITU channel 403

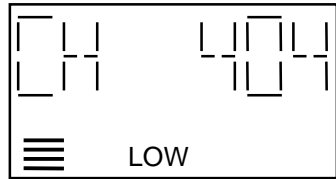

Next ITU channel in memory is 404

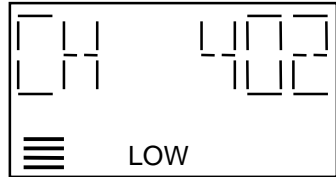

Previous ITU channel in memory is 402

ADVANCED OPERATIONS

SELECTING THE PROGRAM MENU

To enter the program mode
press **1** **FNC**

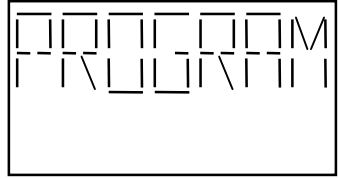

The display will show “PROGRAM”, followed by the first program option. Every time the

FNC key is pressed, the radio will step to the next programming menu option. The options available for programming are “STORE”, “ERASE”, “ALPHA” and “EXIT”.

“**STORE**” will allow saving either the displayed information or entering a new transmit / receive frequency pair and operating mode. If a name tag other than the suggested is used (other than “NEW”), a new scan cell will be created.

“**ERASE**” deletes the bin number entered. Erasing a bin will split a scan cell.

“**ALPHA**” is the name tag edit routine. This routine is also used when storing a display or new frequency pair.

“**EXIT**” will exit the program menu. No channel or frequency information will be stored when EXIT is selected.

NOTE: *Care should be given to the bin number used when programming frequencies. The bin number and name tag will affect how channels are browsed and scanned.*

Consecutive bin numbers that have the same first three characters in their name tag, are known as “scan cells”. SEA has programmed 170 of the 200 possible bins into 23 different scan cells. Scan cells may be as short as one bin or as long as 200 bins but should be kept to a reasonable length for scanning efficiency. Each scan cell is organized with frequency pairs that are related to one another. For example, bins 13 through 30 have been programmed with frequencies assigned to the coast station KMI. Since the name tag’s first three characters are “KMI”, and the bins are consecutively numbered, the bins may be scanned as a group. If the bins do not have the same first three characters, the scan cell will be split into two different cells. For instance, if bin 20 is renamed to “SEA 1”, the KMI scan cell will be split into two cells. One cell will contain bins 13 through 19, while the other cell will contain bins 21 through 30. Bin 20 will be a single channel scan cell called “SEA”. Scanning “KMI” could be done by scanning bins 13 through 19 **OR** bins 21 through 30 but not both at the same time.

Care should be given that a scan cell is not split unintentionally. Bins that will not be scanned can be given any descriptive name tag.

ADVANCED OPERATIONS

PROGRAM MENU SELECTIONS (cont.)

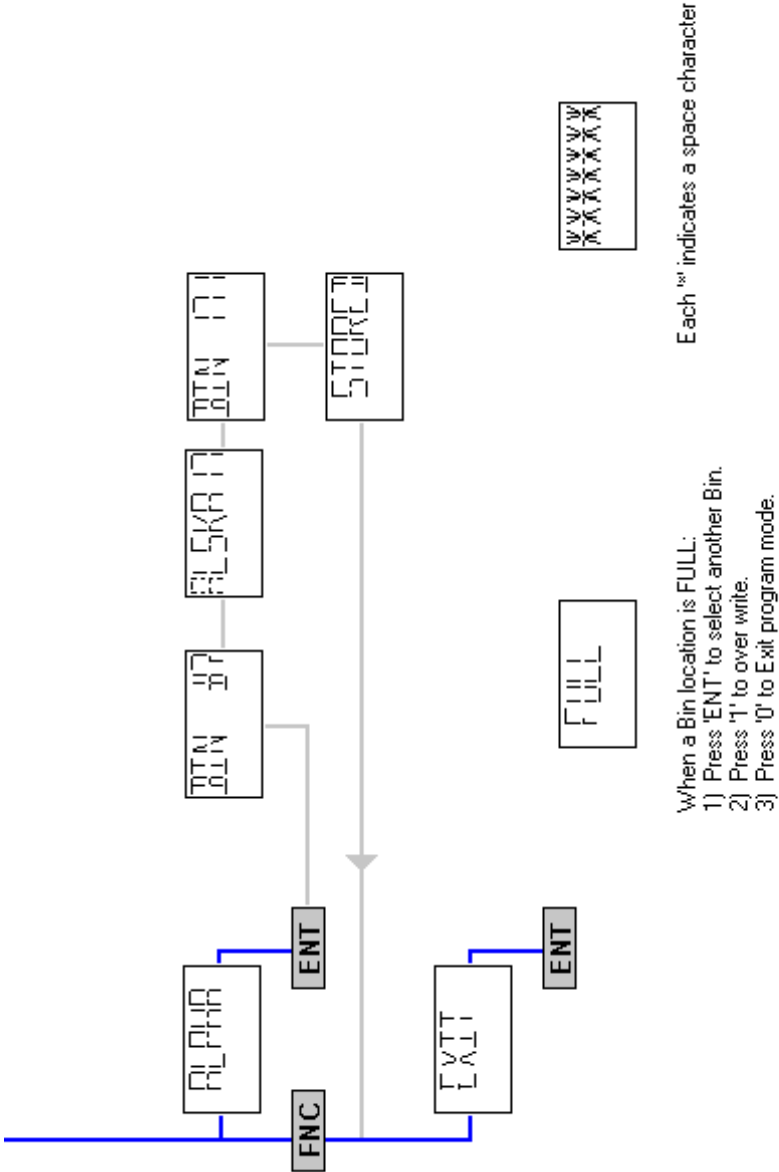

Key Chart 2 - PROGRAM MENU 2

STORING THE DISPLAYED FREQUENCY

After selecting a channel or commonly used frequency, the displayed information may be saved into any bin location. This will include the mode of operation such as **LSB**, receive only, etc. To save the displayed information, press **1** **FNC** to enter the program mode.

Press **ENT** when “STORE” appears on the display.

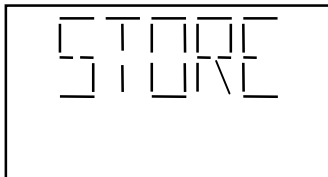

You will be prompted to “PRESS+” for selecting the type of information to store.

Press **UP** or **DN** then **ENT** when “DISPLAY” appears.

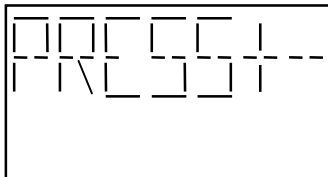

Enter any bin number for storing the displayed frequency followed by **ENT**

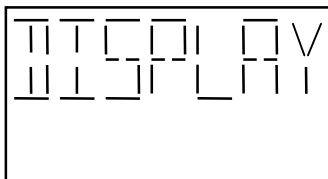

e.g. To save the displayed information to bin number 171 press:



If the bin is “FULL”, you may overwrite the information by pressing **1** or press **ENT** to select a new bin. Pressing **0** **2182** will exit the programming mode.

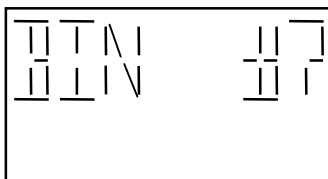

Because bin 170 is factory programmed as “ALSKA16”, the radio will make the assumption that the operator will want this channel’s name tag to be ALSKA17.

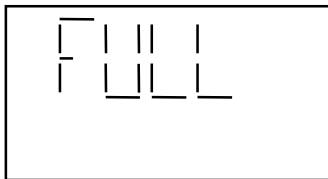

The character that is ready to edit will blink. If you wish to leave the character the same press **ENT**. Press **UP** or **DN** to change the blinking character.

Press **ENT** to move to the next character .

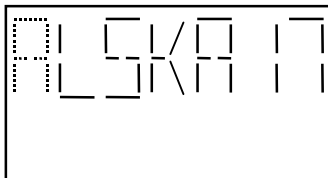



Blinking character may be changed

ADVANCED OPERATIONS

STORING THE DISPLAYED FREQUENCY (cont.)

After accepting or editing the name tag, the operator is again prompted to “PRESS+”.

Pressing  or  will cycle through the final options of “SAVE”, “EDIT” and “EXIT”.



Pressing  when “SAVE” is displayed will save the information to the bin number chosen.

“EDIT” allows the name tag to be changed or corrected for the selected bin.

“EXIT” will leave the program mode without saving the information to the selected bin unless “SAVE” is selected before “EXIT”.

After saving the information, “BIN 171”, followed by “STORED” will appear indicating that the information has been saved.

The radio will stay in the program mode asking if the operator wishes to “STORE” another channel.

To exit the program mode, press the  key to have “EXIT” appear then  to restore the radio to normal operations.

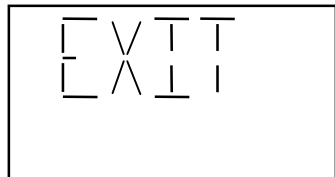
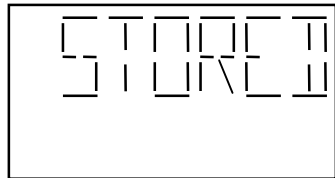
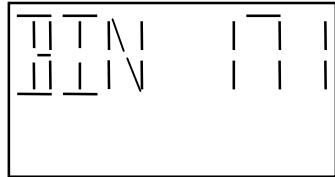
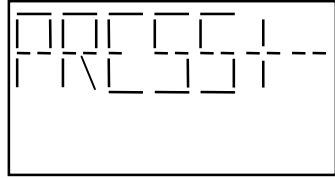

PROGRAMMING A NEW FREQUENCY

The SEA 235 allows the operator to store a new frequency pair that is not the current displayed frequency. This is useful when more than one bin location is to be programmed while in program mode. This will include the mode of operation such as LSB, receive only, etc. To save a new frequency pair to a bin location, press **1** **FNC** to enter the program mode.

Press **ENT** when “STORE” appears on the display.

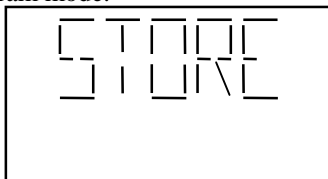

You will be prompted to “PRESS+” for selecting the type of information to store.

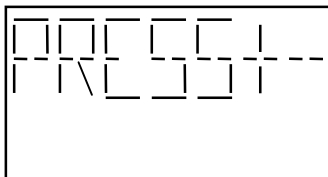

Press **UP** or **DN** then **ENT** when “NEW” appears.



Enter the bin number for storing the new frequency followed by **ENT**

e.g. To save the displayed information to bin number 171 press:

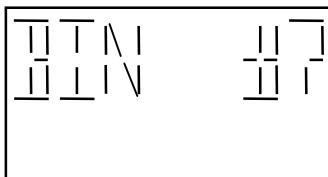

If the bin is “FULL”, you may overwrite the information by pressing **1** or press **ENT** to select a new bin. Pressing **0** **2182** will exit the programming mode.



When “RX FREQ” is displayed, enter a receive frequency.

If the receive frequency is not between 490.0 KHz and 29999.9 KHz, “ILLEGAL” will be displayed.

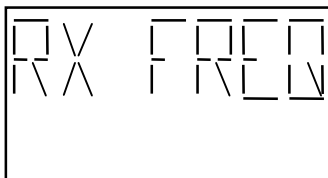



ADVANCED OPERATIONS

PROGRAMMING A NEW FREQUENCY (cont.)

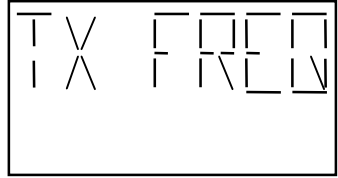
Enter the transmit frequency at the “TX FREQ” prompt. If a receive only channel is needed, press  at the “TX FREQ” prompt. The transmit frequency must be between 1600.0 KHz and 29999.9 KHz.



The choices for the “MODE” prompt can be selected by pressing the  or  keys.

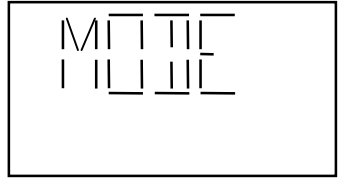

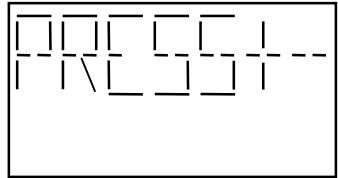

The available modes are “USB”, “LSB”, “TELEX”, “TLX - GW”, “TLX - PD”, “AME”, “CW” and “TRUE AM”.

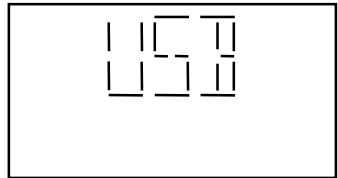

When the required mode of operation is displayed press . Normally, all marine communications are USB or TELEX.



Because bin 170 is factory programmed as “ALSKA16”, the radio will make the assumption that the operator will want this channel’s name tag to be ALSKA17.

The character that is ready to edit will blink. If you wish to leave the character the same press . Press  or  to change the blinking character.

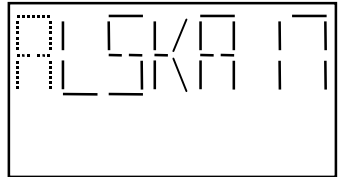

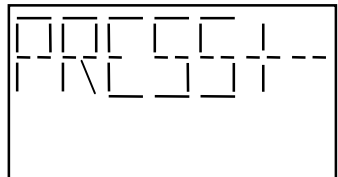

Blinking character may be changed

Press  to move to the next character.



After accepting or editing the name tag, the operator is again prompted to “PRESS+”.

PROGRAMMING A NEW FREQUENCY (cont.)

Pressing  or  will cycle through the final options of “SAVE”, “EDIT” and “EXIT”.



Pressing  when “SAVE” is displayed will save the information to the bin number already entered.

“EDIT” allows the name tag to be changed or corrected for the selected bin.

“EXIT” will leave the program mode without saving the information to the selected bin unless “SAVE” is selected before “EXIT”.

“BIN 171” “STORED” will appear indicating that the information has been saved.

The radio will stay in the program mode asking if the operator wishes to STORE another channel.

To exit the program mode, press the  key to have “EXIT” appear then  to restore the radio to normal operations.

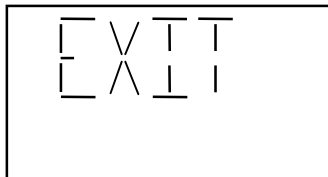
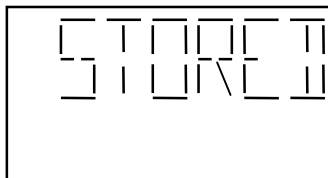

ADVANCED OPERATIONS

ERASING A CHANNEL

Any frequency pair located in scratchpad memory may be erased. To erase a frequency pair in a bin location, press **1** **FNC** to enter program mode.

When “STORE” appears on the display, press the **FNC** key until “ERASE” appears.



Press **ENT** at the “ERASE” display.

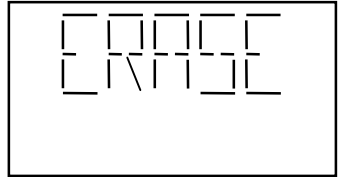

Enter the bin number of the channel you wish to erase followed by **ENT**

e.g. To erase bin number 171 press:

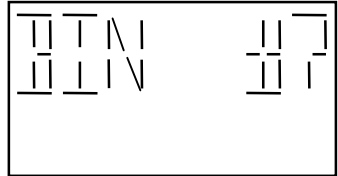

The display will show “ERASED” and return to the beginning of the program mode.

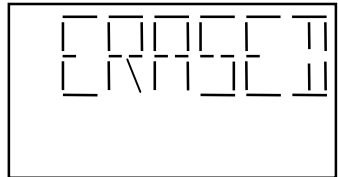

To exit the program mode, press the **FNC** key to have “EXIT” appear then **ENT** to restore the radio to normal operations.



CHANGING THE NAME TAG OF A BIN

The name tag given to a bin location may be changed at any time. To rename a bin location, press **1** **FNC** to enter program mode.

When “STORE” appears on the display, press the **FNC** key until “ALPHA” appears.



Press **ENT** at the “ALPHA” display.

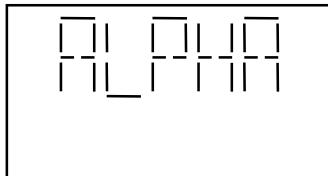

Enter the bin number that is needed to be renamed followed by **ENT**. Bins 196 to 200 are assigned to “NECODE” and can not be renamed.

e.g. To rename bin number 2 (WWV 2) to show it is the 5 MHz WWV frequency press: **2** **ENT**

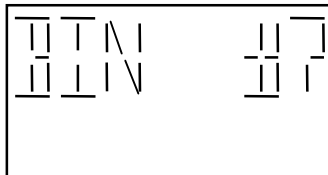

The name tag for the selected channel will appear with the first character blinking. If you wish to leave the character the same press **ENT**. Press **UP** or **DN** to change the blinking character.

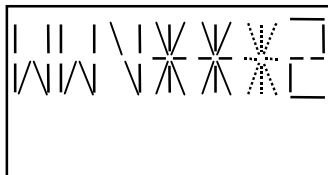

Press **ENT** to move to the next character.

The “*” character indicates a space.

After the final character is entered, the display will show “BIN 2” “STORED” and return to the beginning of the program mode.

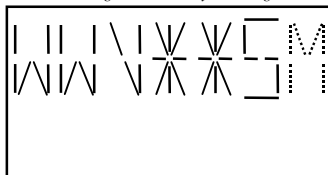

NOTE: Care should be given when renaming bins.

When a bin in a scan cell (bins that share the same first three characters in their name tag) is renamed, the group will be split. For example, bins 13 through 30 have been programmed with frequencies assigned to the coast station KMI. Since the name tag’s first three characters are “KMI”, and the bins are consecutively numbered, the bins may be scanned as a group. If the bins do not have the same first three characters, the scan cell will be split into two different cells. For instance, if bin 20 is renamed to “SEA 1”, the KMI scan cell will be split into two cells. One cell will contain bins 13 through 19, while the other cell will contain bins 21 through 30. Bin 20 will be a single channel scan cell called “SEA”. Scanning “KMI” could be done by scanning bins 13 through 19 **OR** bins 21 through 30 but not both at the same time.

ADVANCED OPERATIONS

SCANNING A CHANNEL GROUP

Consecutive bin locations that have the same first three characters in their name tag, are known as “scan cells”. SEA has programmed 170 of the 200 possible bins into 23 different scan cells. Scan cells may be as short as one bin or as long as 200 bins but should be kept to a reasonable length for scanning efficiency. Each scan cell is organized with frequency pairs that are related to one another. To scan a group of channels, first select a bin within a scan cell.

e.g. To scan the KMI marine operator channels programmed in bin locations 13 through 30, select any bin between 13 and 30 followed by “ENT”.

Press **1** **3** **ENT**

After the name is shown for the selected bin, press **2** **FNC** to start the scan.

Press **FNC** repeatedly until “VOICE” is displayed then press **ENT**

The radio will turn on the “SQL” indicator and begin the scan of bins 13 through 30. The first time through the scan cell, each bin is sampled for approximately 7 seconds. When the last bin in the scan cell has been sampled, the scan speed will increase to 1 bin every ¼ second. When an audio signal is received, the radio will open the squelch and stay on channel for as long as the signal is present and changing.

When “PAUSE” scan is selected and a signal is received, the radio will stay on the channel for a maximum of 5 seconds and continue to the next bin even if the signal is still present. This is a good selection when scanning active channels.

“TELEX” scan reduces the speed to 1 channel every 4 seconds. The additional time is required to determine when a valid signal is present.

“NECODE” scan is for scanning the Nocode bins, 196 through 200. This special scan mode looks for a 2 KHZ tone indicating a possible Nocode signal. The scan speed is increased to approximately 5 channels every ½ second.

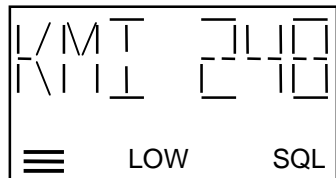
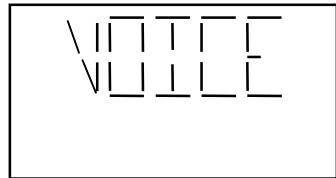
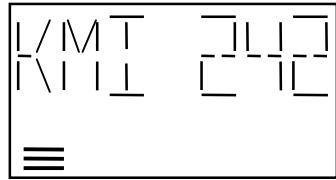

DIRECT FREQUENCY

When a frequency is entered into the radio, it is a receive only frequency. The 'Direct Frequency' function allows the operator to input transmit and receive frequencies along with a mode of operation.

To enter a transmit frequency using the direct frequency function press **3** **FNC**



Enter the receive frequency at the "RX FREQ" prompt followed by **ENT**. This frequency must be in the range of 490.0 KHz to 29999.9 KHz.



At the "TX FREQ" prompt, enter the transmit frequency followed by **ENT**. If both the transmit and receive frequency are the same you can press **ENT**. If the frequency being entered is receive only, press **0** **2182**

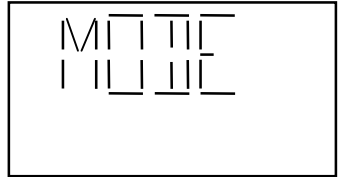

The transmit frequency must be in the range of 1600.0 KHz and 29999.9 KHz.

After entering the transmit frequency, you will need to select the "MODE" of operation. Press the **UP** or **DN** key at the "PRESS+" prompt.

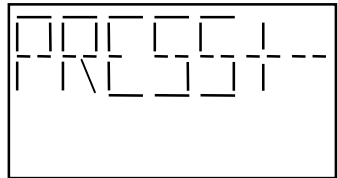

Press the **ENT** key when the required mode is displayed.

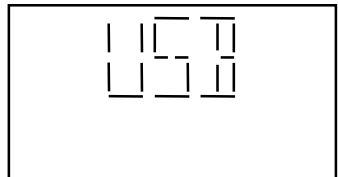

Under normal operations, USB is used for all marine communications.

If the frequency entered (transmit or receive) is outside the radio's specified range, the display will show "ILLEGAL" and return to normal radio operations.



ADVANCED OPERATIONS

INTERCOM

When multiple controllers are connected to the SEA 235, the radio may be used as an all station intercom system.

Press **5** **FNC** to start the intercom.



Speaking into the microphone when the PTT button is pressed will allow all other controllers to hear what is spoken. When in the receive position, the radio will receive any other controller intercom messages. Rotating the volume control will adjust the audio level for the individual station.

If the intercom has not been used for 3 minutes, the radio will revert back to normal radio operations. To stop intercom operations before the end of the 3 minutes, press **ENT**

FUNCTION MENU OVERVIEW

When the FNC key is pressed, the radio displays the first of four function menus. Each press of the FNC key will display the next function menu. When the last menu item is displayed, the next press of the FNC key will return the radio to normal operations. Pressing the ENT key will select the displayed menu. The menus are “ALPHA”, “MODE”, “POWER”, “DIMMER”, “SQ ADJ” and “SETUP”.

Each function menu will prompt “PRESS+”, informing the operator to use the UP or DN key to cycle through the options for the chosen function menu.

Selecting the displayed option with the ENT key will complete the command or additional prompts will be displayed if more information is required.

e.g. The following diagram shows the “VLO PWR” option being selected from the “POWER” function menu.

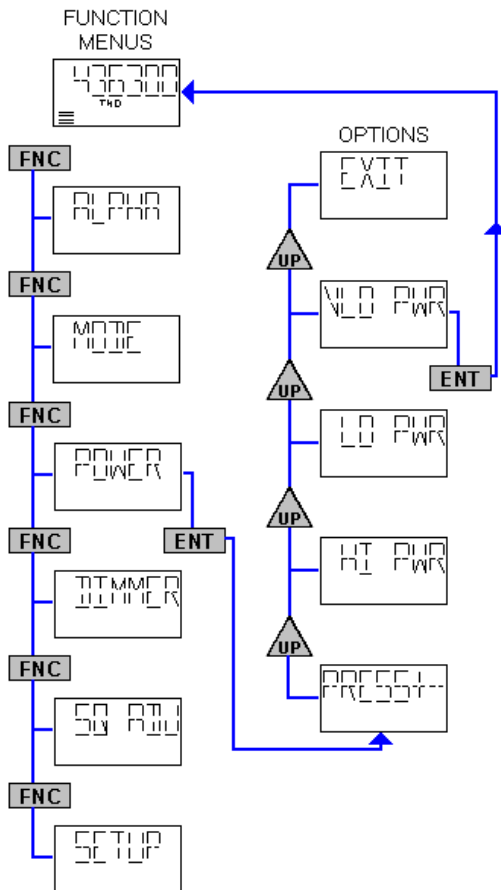

FUNCTION MENUS

FINDING A BIN WITH THE ALPHA MENU

In many cases it is difficult to remember where a frequency is stored by its bin number. The ALPHA menu along with *Memory Browse*, is a useful method for locating a particular bin by name. Locating the 8 MHz weather fax frequency for NAM in Norfolk, VA will be used as an example.

Repeatedly press **FNC** until “ALPHA” is displayed.

Pressing **ENT** with “ALPHA” displayed will select the Alpha menu. The display will prompt the operator to “PRESS+” to cycle through the scan cells.

The scan cell names that appear with each press of the **UP** or **DN** key may appear cryptic, but should give an indication for each scan cell’s purpose. The weather fax groups programmed by SEA have “WFX” as the last part of their name. The first part may be “CG” for Coast Guard or “HI” for Hawaii. NAM is located in Virginia (“VA”) so “VAWFX” would be the most likely scan cell.

Press **ENT** at the “VAWFX” display to select the “VAWFX” scan cell.

Press **UP** or **DN** to view the different bins within the “VAWFX” scan cell. Press **ENT** to select the displayed bin. Press **CH FX** to view the frequency. If the bin does not contain the desired frequency, turn on *Memory Browse* by pressing **9** **UP**. When browsing the “VAWFX” channels with **UP** or **DN**, use the **CH FX** key to verify the frequency.

Push **ENT** to retrieve the selected bin.

Momentarily press the microphone PTT button to exit the *Memory Browse*.

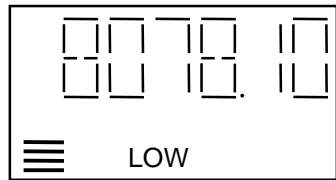
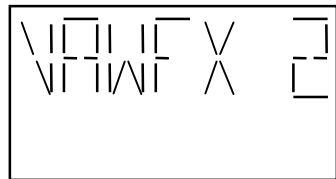
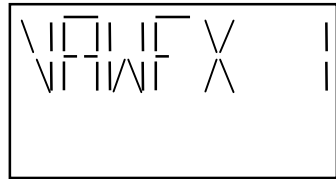
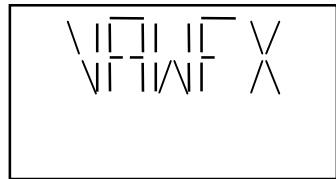
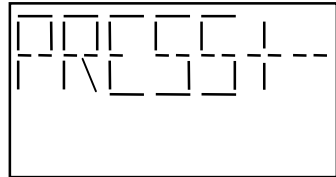
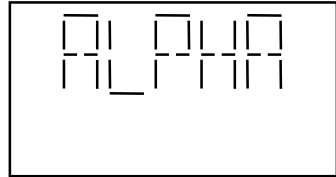

CHANGING THE MODE WITH THE MODE MENU

When the radio is turned on, the default configuration is the “MARINE” operating system using the USB mode. The “MARINE” operating system restricts the mode selections to prevent illegal transmissions. If a frequency is required to use one of these ‘restricted’ modes, a bin should be programmed with that mode.

Repeatedly press **FNC** until “MODE” is displayed.

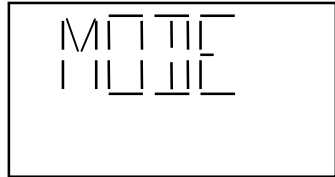

Pressing **ENT** with “MODE” displayed will prompt the operator to “PRESS+-”.

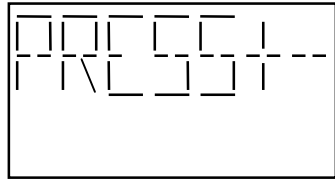

The mode names that appear with each press of the **UP** or **DN** key are the seven available operating modes for transmit and receive. Select the displayed mode with **ENT**

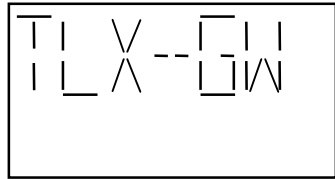

In the “MARINE” operating system, only USB, TELEX, TLX-GW, TLX-PD and AME (2182.0 KHz only) are legal for transmitting. When selected, a prompt will appear asking for a bin or ITU/SEA channel number. Enter the channel number followed by **ENT**

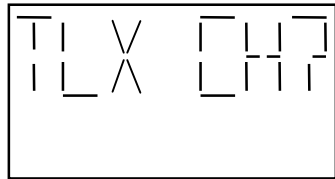

The remaining three modes are LSB, CW and TRUE AM. If selected while using the “MARINE” operating system, transmission is not allowed and a prompt will ask for the receive frequency. When changing the mode for the current frequency or channel, pressing **ENT** at the “RX FREQ” prompt will use the current receive frequency and temporarily make the channel receive only.

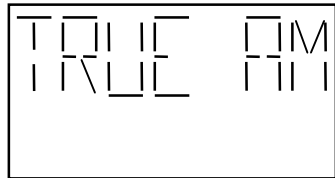

“TRUE AM” is a receive only mode and is automatically selected for broadcast quality when a frequency below 1.6 MHz is entered.



The radio “AMATEUR” operating system does not place any restrictions on the use of modes.

FUNCTION MENUS

MODE MENU SELECTIONS

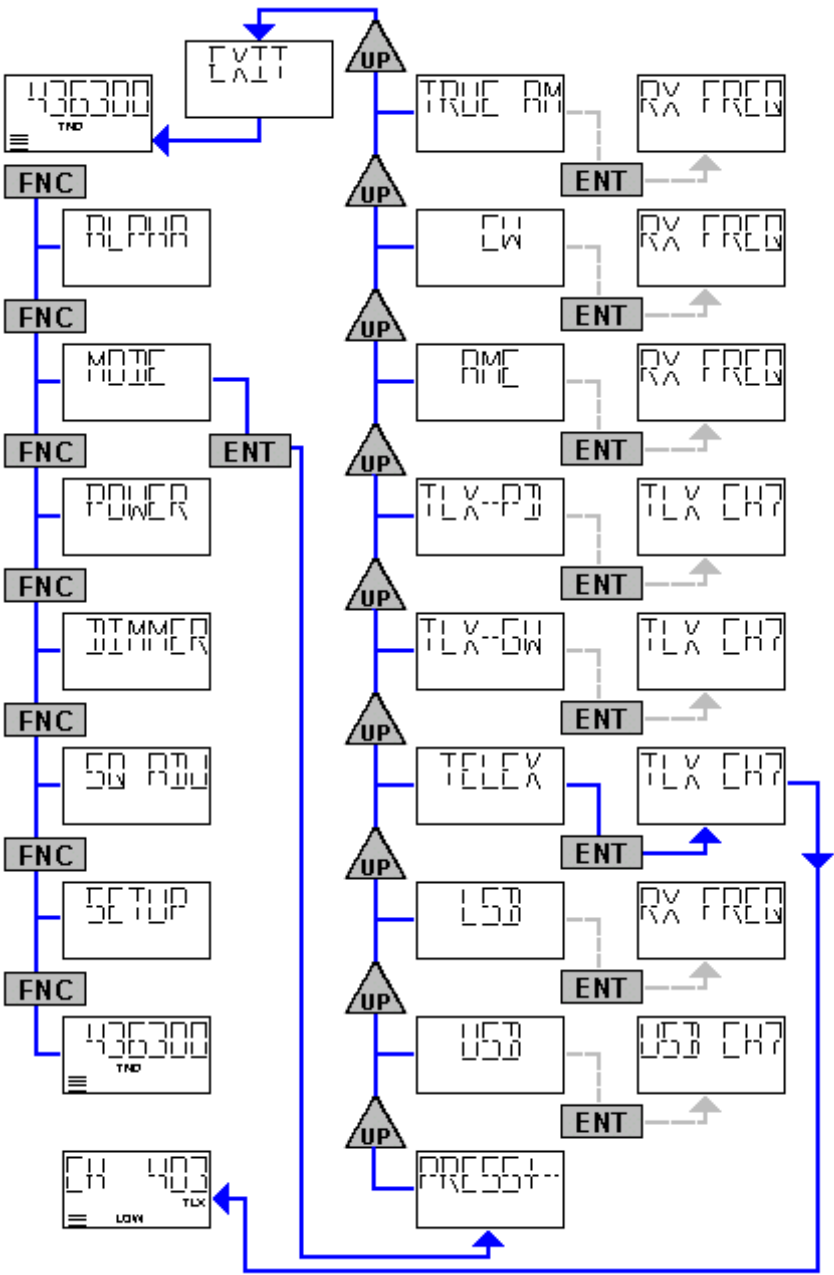

Key Chart 3 - MODE MENU

SELECTING THE TRANSMIT POWER LEVEL

When transmitting, using the lowest amount of power required for reliable communications will help prevent interference with stations located thousands of miles away.

Repeatedly press **FNC** until “POWER” is displayed.

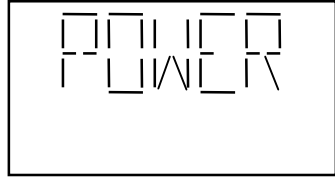

Pressing **ENT** with “POWER” displayed will prompt the operator to “PRESS+”.

The different displays that appear with each press of the **UP** or **DN** key are the three transmit power levels

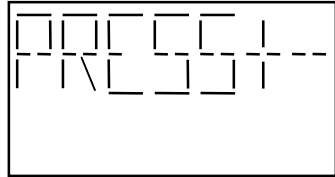

Press **ENT** at the “HI PWR” display to set the radio to 150 watts output during transmit.

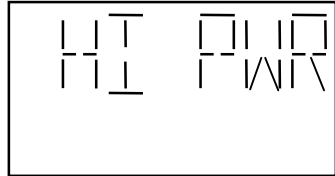

Press **ENT** at the “LO PWR” display to set the radio output for approximately 75 watts during transmit. The display’s “LOW” indicator will appear to show the radio is set to the ½ power setting.

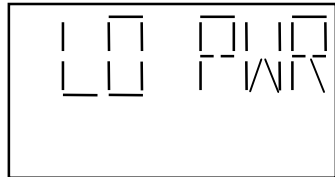

Pressing **ENT** at the “VLO PWR” display will set the radio output for approximately 35 watts during transmit. The display’s “LOW” indicator will flash to indicate the radio is set to the ¼ power setting.

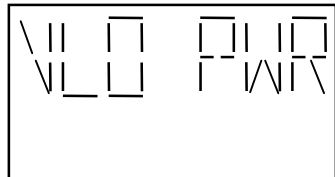

If **ENT** is pressed on the “EXIT” display, the power level will not be changed.

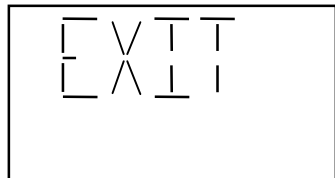

NOTE: When the radio is setup to operate with a tuner, and the tuner is not “matched” to the antenna, the radio’s “LOW” indicator will appear. The radio will not go to high power until the tuner has “matched” the antenna.

FUNCTION MENUS

POWER MENU SELECTIONS

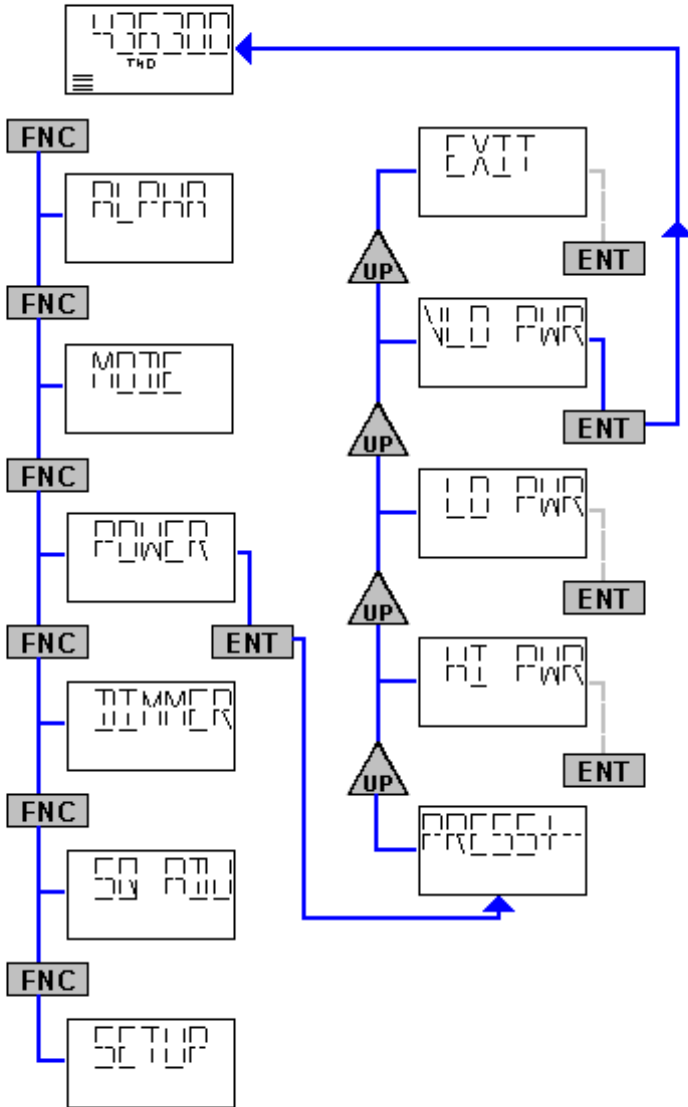

Key Chart 4 - POWER MENU

CHANGING THE DISPLAY ILLUMINATION

Repeatedly press **FNC** until “DIMMER” is displayed, then press the **ENT** key.

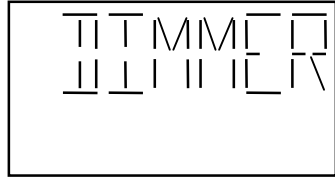

The different displays that appear with each press of the **UP** or **DN** key are the display's four illumination levels



Press **ENT** at the “MAX” display to set the illumination to maximum brightness.

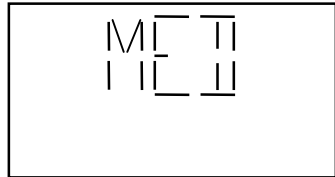

Press **ENT** at the “MED” display to set the illumination to medium brightness.

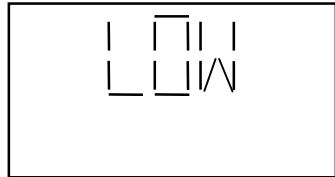

Pressing **ENT** at the “LOW” display will set the illumination to a very dim level.

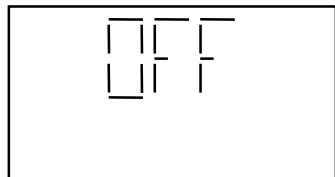

Press **ENT** at the “OFF” display to turn the illumination off. When the illumination is “OFF”, pressing any key except “PWR” will set the illumination to the “LOW” level for five seconds.

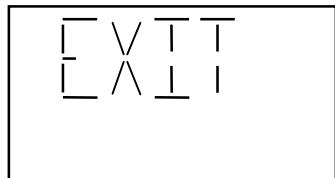

To leave the illumination level unchanged, press **ENT** at the “EXIT” display.

CHANGING THE SQUELCH THRESHOLD

Repeatedly press **FNC** until “SQ ADJ” is displayed, then press the **ENT** key.

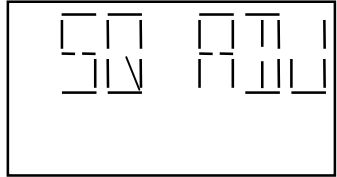

Each press of the **UP** or **DN** key will change the squelch threshold setting. Press **ENT** to select the setting.

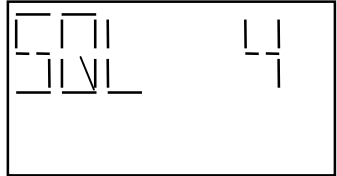

A larger number will require a stronger signal to open the squelch.

If the squelch is turned on before adjusting the threshold, the operator can monitor what level is needed to mute the radio.

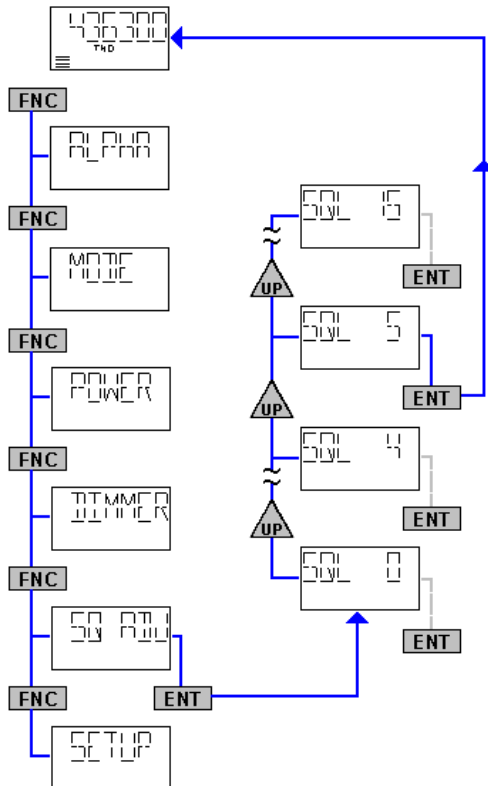

FUNCTION MENUS

SETUP MENU OPTIONS

Options in the setup menu contain some settings that rarely need changing. After determining the best settings for a given installation, these options will very seldom be changed.

To enter the setup menu, repeatedly press **FNC** until “SETUP” is displayed.

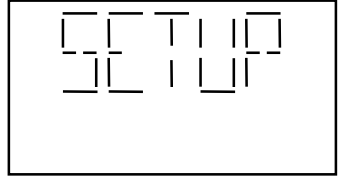

Pressing **ENT** with “SETUP” displayed will prompt the operator to “PRESS+-”.

The different displays that appear with each press of the **UP** or **DN** key are the options that may be adjusted.

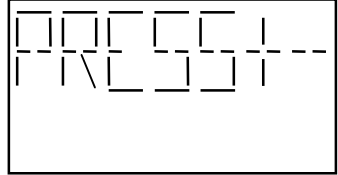

When the option is displayed, press **ENT**. The display will show the current setting for the selected option.

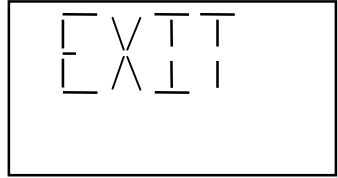

Using **UP** or **DN** will cycle through the available settings.

The displayed setting will be selected when **ENT** is pressed. The radio will return to normal operations after the selection has been entered.

Pressing **ENT** when “EXIT” is displayed, will not change the option setting and the radio will return to normal operations.

The setup options are “**BEEP**”, “**TUNER**”, “**UNIT**”, “**SSB AF**”, “**TLX AF**”, “**SSB AGC**”, “**TLX AGC**” and “**VOGAD**”.

SETUP MENU SELECTIONS

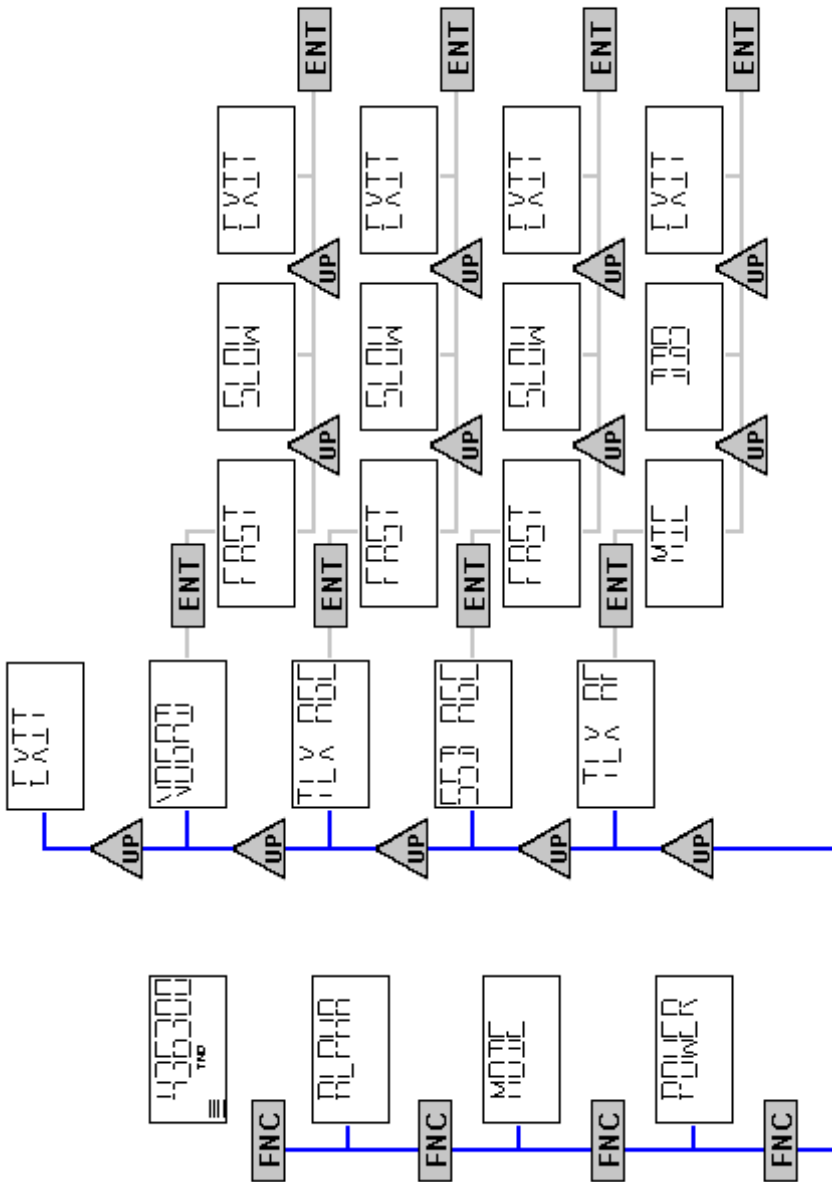

Key Chart 6 - SETUP MENU 1

CHANGING THE KEY BEEP SETTING

Repeatedly press **FNC** until “SETUP” is displayed.

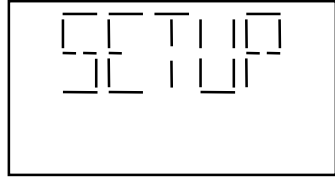

Pressing **ENT** with “SETUP” displayed will prompt the operator to “PRESS+”.

Press the **UP** or **DN** key until “BEEP” is displayed then press **ENT**

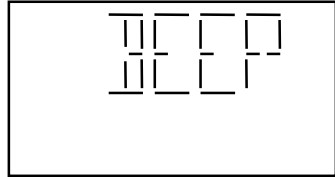

Each press of the **UP** or **DN** key will change the key beep setting. Press **ENT** to select the setting of “ON” or “OFF”.

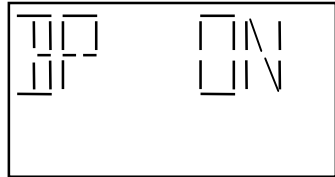

With the key beep turned on, a beep will be heard from the speaker with every key press.

FUNCTION MENUS

CHANGING THE TUNER STATUS

Repeatedly press **FNC** until “SETUP” is displayed.

Pressing **ENT** with “SETUP” displayed will prompt the operator to “PRESS+”.

Press the **UP** or **DN** key until “TUNER” is displayed then press **ENT**

Each press of the **UP** or **DN** key will change the tuner setting. Press **ENT** to select the displayed setting.

Select “TNR ON” when the radio will be used with a SEA 1612B, 1612C or 1635 antenna tuner. The “LOW” indicator will appear on the display to show the antenna is not tuned for full output power. The tuner will “match” the antenna when the operator does one of the following:

- 1) Speaks into the microphone during transmit
- 2) Holds the microphone PTT and presses the **FNC** key. The radio will output a signal to “match” the antenna.

When the tuner has finished “matching” the antenna, the VSWR will be displayed, the “LOW” indicator will turn off and full power will be transmitted.

Select “TNR OFF” when using a tuner that does not supply a ground potential “TND” signal. Pressing the **FNC** key while the PTT is held will not transmit a signal for “matching” the antenna.

If the **FNC** key is pressed at the “EXIT” display, the tuner status is not changed.

NOTE: If the operator has set the radio to “LO PWR” or “VLO PWR” via the power setup menu, and the tuner has found a “match”, the radio will not increase to full power until the operator manually changes the output power to “HI PWR”.

SETUP

TNR ON

TNR OFF

TNR ON LOW

TNR OFF LOW

EXIT

CHANGING THE CONTROLLER UNIT NUMBER

Repeatedly press **FNC** until “SETUP” is displayed.

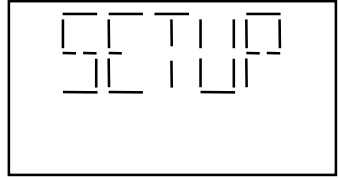

Pressing **ENT** with “SETUP” displayed will prompt the operator to “PRESS+”.

Press the **UP** or **DN** key until “UNIT” is displayed then press **ENT**

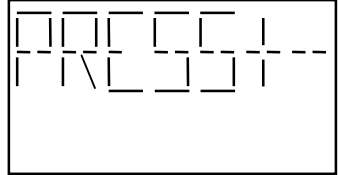

Each press of the **UP** or **DN** key will change the controller’s assigned number. Press **ENT** to select the displayed setting.

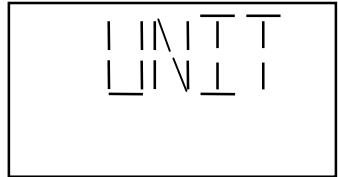

The default controller number is “1”. The unit number can be changed from 1 to 9.

A recommended maximum of four controllers may be connected to the radio at the same time. Both the receive and transmit audio level will decrease slightly when additional controllers are connected.



Each controller must be assigned a different number.

FUNCTION MENUS

CHANGING THE SSB AUDIO INPUT SOURCE

Repeatedly press **FNC** until “SETUP” is displayed.

Pressing **ENT** with “SETUP” displayed will prompt the operator to “PRESS+-”.

Press the **UP** or **DN** key until “SSB AF” is displayed then press **ENT**

Each press of the **UP** or **DN** key will change where the radio will get transmit audio when in SSB modes. Press **ENT** to select the displayed setting.

Under normal conditions, the transmit SSB audio will come from the microphone. When set for “MIC”, the rear panel P3 connector pin 12 (TXAF) and DB9 pin 7 are disabled. This will prevent interference from other equipment that may be connected to the radio.

Both the DB9 connector pin 7 and the rear panel P3 connector pin 12 (TXAF), are used when the “SSB AF” setting is “DB9”. When set for “DB9”, the internal microphone and rear panel P3 connector pin 3 (MIC) are disabled. This will prevent the microphone from causing interference to the additional equipment.

Pressing the **ENT** key when “EXIT” is displayed, will not change the setting.

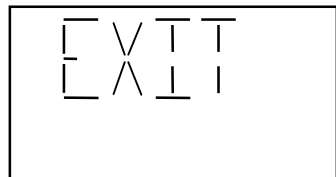
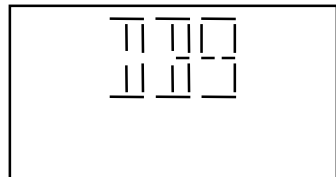
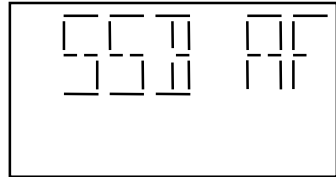
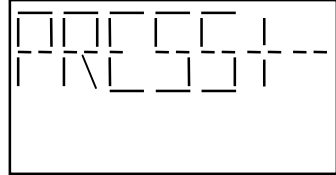
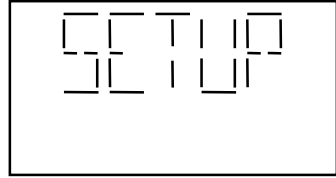

NOTE: Normal voice operations require that the “SSB AF” source is set to “MIC”.

CHANGING THE TELEX AUDIO INPUT SOURCE

Repeatedly press **FNC** until “SETUP” is displayed.

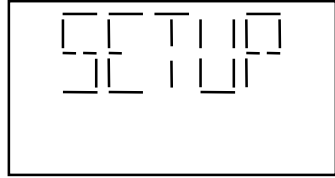

Pressing **ENT** with “SETUP” displayed will prompt the operator to “PRESS+-”.

Press the **UP** or **DN** key until “TLX AF” is displayed then press **ENT**

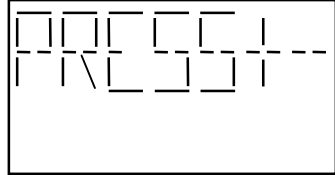

Each press of the **UP** or **DN** key will change where the radio will get transmit audio when in TLX modes. Press **ENT** to select the displayed setting.

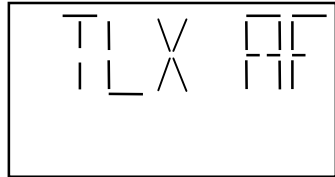

Under certain conditions, the transmit TLX audio will come from the rear panel P3 connector pin 3 (MIC). When set for “MIC”, the rear panel P3 connector pin 12 (TXAF) and DB9 pin 7 are disabled. This will prevent interference from other equipment that may be connected to the radio.

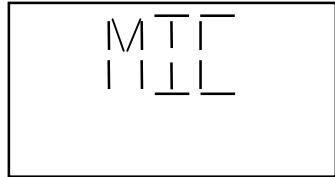

Under normal conditions, the transmit TLX audio should come from the DB9 connector pin 7 or the rear panel P3 connector pin 12 (TXAF). These connections are used when the “TLX AF” setting is “DB9”. When set for “DB9”, the internal microphone and rear panel P3 connector pin 3 (MIC) are disabled. This will prevent the microphone from causing interference to the additional equipment.

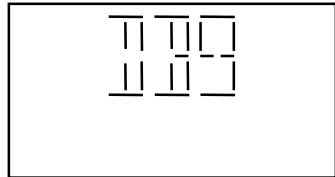

Pressing the **ENT** key when “EXIT” is displayed, will not change the setting.

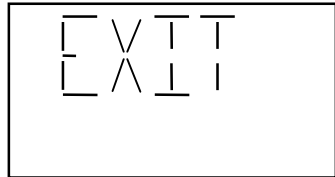

FUNCTION MENUS

CHANGING THE SSB AGC CHARACTERISTICS

The SSB AGC controls the radio's receiver gain when receiving non TELEX mode signals. The characteristics may be changed to one of two settings labeled "FAST" and "SLOW". The "FAST" setting uses feedforward AGC.

Feedforward AGC is an aggressive AGC system that is very noise immune and keeps the audio level fairly constant for received signals of different strength. When "SLOW" is selected, the feedforward AGC is disabled and the receiver will sound more like a conventional SSB receiver.

Repeatedly press **FNC** until "SETUP" is displayed.

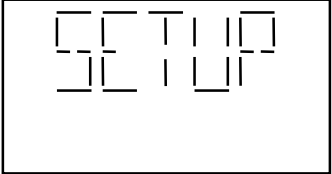

Pressing **ENT** with "SETUP" displayed will prompt the operator to "PRESS+-".

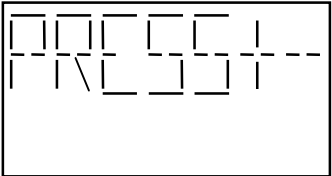

Press the **UP** or **DN** key until "SSB AGC" is displayed then press **ENT**.

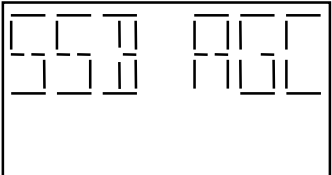

Each press of the **UP** or **DN** key will change the SSB AGC characteristics. Press **ENT** to select the displayed setting.

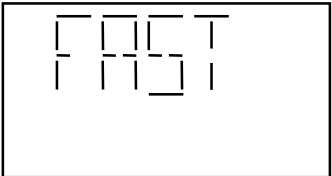

Use a setting of "FAST" (default) for better signal to noise ratio on weaker signals.

Use a setting of "SLOW" for a more conventional sounding SSB receiver.



When "EXIT" is selected, the setting will not be changed.

CHANGING THE TELEX AGC CHARACTERISTICS

The TLX AGC controls the radio's receiver gain when receiving TELEX mode signals. The characteristics may be changed to one of two settings labeled "FAST" and "SLOW". The "FAST" setting uses feedforward AGC. Feedforward AGC is an aggressive AGC system that is very noise immune and keeps the audio level fairly constant for received signals of different strength. Some forms of TELEX such as "CLOVER" requires a "SLOW" setting to properly receive the signal. Refer to the data provided by the specific MODEM manufacturer.

Repeatedly press **FNC** until "SETUP" is displayed.

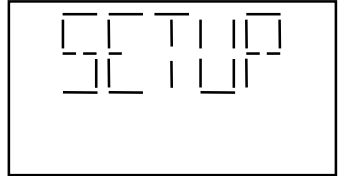

Pressing **ENT** with "SETUP" displayed will prompt the operator to "PRESS+-".

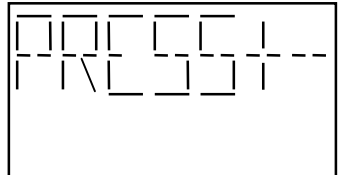

Press the **UP** or **DN** key until "TLX AGC" is displayed then press **ENT**

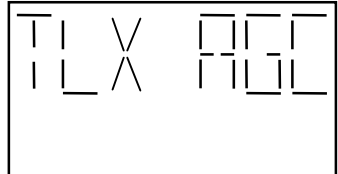

Each press of the **UP** or **DN** key will change the TLX AGC characteristics. Press **ENT** to select the displayed setting.

Use a setting of "FAST" (default) for better signal to noise ratio on weaker signals.

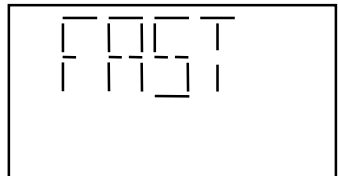

Use a setting of "SLOW" for a more complex TELEX modulation method.

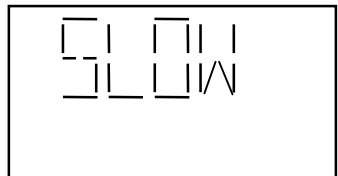

When "EXIT" is selected, the setting will not be changed.

FUNCTION MENUS

CHANGING THE VOGAD CHARACTERISTICS

Repeatedly press **FNC** until “SETUP” is displayed.

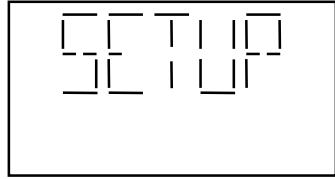

Pressing **ENT** with “SETUP” displayed will prompt the operator to “PRESS+-”.

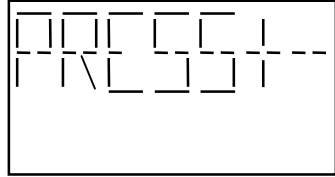

Press the **UP** or **DN** key until “VOGAD” is displayed then press **ENT**

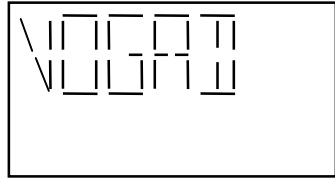

Each press of the **UP** or **DN** key will change the VOGAD characteristics. Press **ENT** to select the displayed setting.

The VOGAD parameters are used for the transmit signal. Very similar to the receiver AGC settings, the normal VOGAD setting is “SLOW”. It should not be necessary to change this setting unless instructed to do so by the factory.

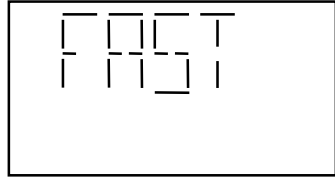

When “EXIT” is selected, the setting will not be changed.



THE RADIO AMATEUR OPERATING SYSTEM

Primarily designed to be used in marine applications, the SEA 235 may also be used as an amateur radio transceiver. When power is first applied to the radio, the “MARINE” operating system is automatically started. Due to the stringent operating requirements used for marine operations, this mode is very restrictive for a licensed amateur radio operator working the ham bands.

An additional feature of the SEA 235 is a special operating function known as the “AMATEUR” operating system. This mode of operation gives the user more flexibility by allowing the clarifier to operate beyond the ± 200 Hz limit required in the “Marine” mode. Additionally, the ability to have the transmit frequency track the receive frequency at any time, allows a “dial around” approach more commonly used for the amateur bands.

To start the “AMATEUR” operating system, press **7** **3** **FNC**.

The display will briefly show “AMATEUR”, indicating the mode has changed.

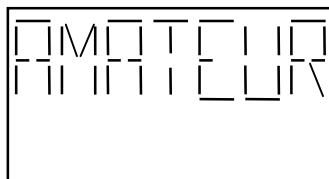

The “AMATEUR” mode differs from the “MARINE” in the following ways:

- 1) ITU/SEA channels are not valid. Bin selections are allowed.
- 2) “Direct Frequency” entry mode is always enabled.
- 3) Frequencies entered below 10 MHz will default to LSB while frequencies entered above 10 MHz will default to USB.
- 4) All operating modes except “TRUE AM” are available for transmit.
- 5) The R.I.T. (clarifier) limit restrictions are removed and may be changed to 10 Hz, 100 Hz, 1 KHz or 10 KHz step sizes
- 6) When the transmit and receive frequency are locked, the transmit frequency will use the same frequency as receive. The clarifier will move both simultaneously. When the frequencies are not locked together, the display’s least significant digit will blink once every second and the clarifier will only affect the receive frequency.
- 7) Pressing the microphone PTT will unlock the two frequencies.
- 8) Pressing **CH** **FX** will lock the two frequencies together.



Pressing the **0** **2182** key, **7** **3** **FNC** or **PWR** will return the radio to the “MARINE” operating system.

AMATEUR OPERATING SYSTEM

FREQUENCY LISTINGS

SEA 235 VOICE FREQUENCY LISTING

VOICE CHANNEL	SHIP RECEIVE	SHIP TRANSMIT	USE
201	2003.0	2003.0	Ship-to-Ship, Great Lakes
202	2450.0	2003.0	KMI Point Reyes, CA
203	2006.0	2006.0	Alaska
205	2446.0	2009.0	WLO, Mobile, AL
206	2506.0	2009.0	WAH, St. Thomas
208	2030.0	2030.0	Virgin Islands, Intership
209	2490.0	2031.5	WOM, Ft. Lauderdale, FL
211	2054.0	2054.0	British Columbia WX
212	2065.0	2065.0	Ship-to-Ship
213	2079.0	2079.0	Ship-to-Ship
214	2082.5	2082.5	Ship-to-Ship Only
215	2086.0	2086.0	Ship-to-Ship, Miss. River Limited Coast
216	2585.0	2086.0	KRV, Pence Playa, WAH, St. Thomas, VI
217	2093.0	2093.0	Ship-to-Ship Only Commercial Fish
218	2096.5	2096.5	Ship-to-Ship, Ship to Limited Coast Station
219	2115.0	2115.0	Alaska
220	2118.0	2118.0	Alaska
221	2514.0	2118.0	WOM, Ft. Lauderdale, FL WLC, Rogers City, MI
223	2309.0	2131.0	WOU-23, Kodiak, AK
224	2312.0	2134.0	WGG-53, Cold Bay, AK
225	2530.0	2134.0	KBP, Kahuka, HI, KOP, Galveston
226	2134.0	2134.0	Eastern Canada Intership
227	2538.0	2142.0	KCC, Corpus Christi, TX
228	2142.0	2142.0	CA Intership
229	2146.0	2146.0	
230	2550.0	2158.0	PJC, Curacao
231	2550.0	2166.0	VRT, Bermuda
232	2558.0	2186.0	WOO, Manahawkin, NJ
233	2582.0	2166.0	8PO, Barbados, C6XZ, Marsh Harbor
234	2558.0	2198.0	VPN-2, Nassau Weather
236	2203.0	2203.0	Ship-to-Ship, Gulf of Mexico

FREQUENCY LISTINGS

SEA 235 VOICE FREQUENCY LISTING

VOICE CHANNEL	SHIP RECEIVE	SHIP TRANSMIT	USE
238	2582.0	2206.0	WBL, Buffalo, NY VCS, Halifax, Canada
239	2397.0	2237.0	WDV-26, Cordova WGG-56, Ketchikan, AK
240	2400.0	2240.0	WGG-58, Juneau, AK WGG-55, Nome, AK
241	2735.0	2290.0	9YL, North Post, Trinidad
242	2450.0	2366.0	
245	2566.0	2390.0	WOM, Ft Lauderdale, FL
246	2400.0	2400.0	
247	2442.0	2406.0	WOM, Ft Lauderdale, FL
248	2506.0	2406.0	KMI, Point Reyes, CA
249	2419.0	2419.0	Alaska
250	2422.0	2422.0	Alaska
251	2427.0	2427.0	Alaska
252	2572.0	2430.0	WLO, Mobile, AL
254	2430.0	2430.0	Alaska
255	2447.0	2447.0	Alaska
256	2450.0	2450.0	Alaska
257	2506.0	2458.0	KGN, Delcambre, LA
258	2479.0	2479.0	Alaska
259	2482.0	2482.0	Alaska
261	2506.0	2506.0	Alaska
262	2509.0	2509.0	Alaska
263	2512.0	2512.0	FFP, Ft. DeFrance, Windward Is.
264	2545.0	2545.0	
265	2527.0	2527.0	Alaska
266	2535.0	2535.0	
267	2538.0	2538.0	Alaska
268	2563.0	2583.0	Alaska
269	2566.0	2566.0	Alaska
270	2582.0	2582.0	Alaska
271	2590.0	2590.0	Alaska
273	2616.0	2616.0	Alaska
275	2638.0	2638.0	Ship-to-Ship
276	2640.0	2640.0	
277	2670.0	2870.0	USCG Working
278	2704.0	2704.0	Ocean Racing

FREQUENCY LISTINGS

SEA 235 VOICE FREQUENCY LISTING

VOICE CHANNEL	SHIP RECEIVE	SHIP TRANSMIT	USE
279	2735.0	2735.0	9YL, North Post, Trinidad
280	2738.0	2738.0	Ship-to-Ship Except Great Lakes and Gulf
281	2782.0	2782.0	Ship-to-Ship River WFN, Jeffersonville, IN WGK, St. Louis, MO WJG, Memphis, TN
282	2830.0	2830.0	Ship-to-Ship, Gulf Only
283	2237.0	2237.0	
284	2530.0	2815.0	
285	2040.0	2040.0	
286	2318.0	2318.0	
287	2366.0	2366.0	
288	2469.0	2708.0	
289	2060.0	2798.0	
290	2458.0	2340.0	
291	2085.0	2045.0	NORWEGIAN
292	2048.0	2048.0	NORWEGIAN
293	2051.0	2051.0	NORWEGIAN
294	2057.0	2057.0	NORWEGIAN
302	3198.0	3198.0	Alaska Point-to-Point
303	3201.0	3201.0	Alaska Point-to-Point
304	3258.0	3258.0	Alaska
305	3261.0	3261.0	Alaska
306	3449.0	3449.0	Alaska Aero
401	4357.0	4065.0	KMI, Point Reyes, CA WAH, St. Thomas, VI
402	4360.0	4068.0	
403	4363.0	4071.0	WOM, Ft. Lauderdale, FL
404	4366.0	4074.0	KGN, Delcambre, LA
405	4369.0	4077.0	WLO, Mobile, AL WLC, Roger City, MI
406	4372.0	4080.0	
407	4375.0	4083.0	
408	4378.0	4086.0	
409	4381.0	4089.0	
410	4384.0	4092.0	WOO, Manahawkin, NJ

FREQUENCY LISTINGS

SEA 235 VOICE FREQUENCY LISTING

VOICE CHANNEL	SHIP RECEIVE	SHIP TRANSMIT	USE
411	4387.0	4095.0	WOO, Manahawkin, NJ
412	4390.0	4098.0	WOM, Ft. Lauderdale, FL
413	4393.0	4101.0	
414	4396.0	4104.0	WLO, Mobile, AL
415	4399.0	4107.0	
416	4402.0	4110.0	KMI, Point Reyes, CA WOO, Manahawkin, NJ
417	4405.0	4113.0	KMI, Point Reyes, CA WOM, Ft. Lauderdale, FL
418	4408.0	4116.0	
419	4411.0	4119.0	WLO, Mobile, AL
420	4414.0	4122.0	
421	4417.0	4125.0	
422	4420.0	4128.0	WOO, Manahawkin, NJ
423	4423.0	4131.0	WOM, Ft. Lauderdale, FL
424	4426.0	4134.0	NMG, New Orleans, LA NMN, Portsmouth, VA, WX
425	4429.0	4137.0	
426	4432.0	4140.0	
427	4435.0	4143.0	
428	4351.0	4060.0	WLO, Mobile, AL
450	4125.0	4125.0	DISTRESS
451	4146.0	4146.0	4A LTD Coast/Intership
452	4149.0	4149.0	4B LTD Coast/Intership
453	4417.0	4417.0	4C LTD Coast/Intership
454	4366.0	4366.0	Alaska
455	4369.0	4369.0	Alaska
456	4396.0	4396.0	Alaska
457	4402.0	4402.0	Alaska
458	4420.0	4420.0	Alaska
459	4423.0	4423.0	Alaska
460	4065.0	4065.0	Mississippi River
461	4089.0	4089.0	Mississippi River
462	4116.0	4116.0	Mississippi River
463	4408.0	4408.0	Mississippi River
501	5164.5	5164.5	Alaska Public Fixed
502	5167.5	5167.5	Alaska Emergency/Calling

FREQUENCY LISTINGS

SEA 235 VOICE FREQUENCY LISTING

VOICE CHANNEL	SHIP RECEIVE	SHIP TRANSMIT	USE
503	5680.0	5680.0	Aero Search/Rescue
504	5472.0	5472.0	Aero Search/Rescue
505	5490.0	5490.0	Aero
601	6501.0	6200.0	NMN, Portsmouth, VA NMG, New Orleans, LA MNA, Miami, FL
602	6504.0	6203.0	
603	6507.0	6206.0	
604	6510.0	6209.0	
605	6513.0	6212.0	
606	6516.0	6215.0	
607	6519.0	6218.0	WLO, Mobile, AL
608	6522.0	6221.0	
650	6215.0	6215.0	DISTRESS
651	6224.0	6224.0	6A LTD Coast/Intership
652	6227.0	6227.0	6B LTD Coast/Intership
653	6230.0	6230.0	6C LTD Coast/Intership
654	6516.0	6616.0	6D LTD Coast DAYTIME ONLY
655	6209.0	6209.0	Mississippi River
656	6212.0	6212.0	Mississippi River
657	6510.0	6510.0	Mississippi River
658	6513.0	6513.0	Mississippi River
801	8719.0	8195.0	
802	8722.0	8198.0	WOM, Ft. Lauderdale, FL
803	8725.0	8201.0	
804	8728.0	8204.0	KMI, Point Reyes, CA
805	8731.0	8207.0	WOM, Ft. Lauderdale, FL
806	8734.0	8210.0	
807	8737.0	8213.0	
808	8740.0	8216.0	WOO, Manahawkin, NJ
809	8743.0	8219.0	KMI, Point Reyes, CA
810	8746.0	8222.0	WOM, Ft. Lauderdale, FL
811	8749.0	8225.0	WOO, Manahawkin, NJ
812	8752.0	8228.0	
813	8755.0	8231.0	

FREQUENCY LISTINGS

SEA 235 VOICE FREQUENCY LISTING

VOICE CHANNEL	SHIP RECEIVE	SHIP TRANSMIT	USE
814	8758.0	8234.0	WOM, Ft. Lauderdale, FL
815	8761.0	8237.0	WOO, Manahawkin, NJ
816	8764.0	8240.0	
817	8767.0	8243.0	
818	8770.0	8246.0	
819	8773.0	8249.0	
820	8776.0	8252.0	
821	8779.0	8255.0	
822	8782.0	8258.0	KMI, Point Reyes, CA
823	8785.0	8261.0	
824	8788.0	8264.0	WLO, Mobile, AL
825	8791.0	8267.0	WOM, Ft. Lauderdale, FL
826	8794.0	8270.0	WOO, Manahawkin, NJ
			WLC, Rogers City, MI
827	8797.0	8273.0	
828	8800.0	8276.0	
829	8803.0	8279.0	
830	8806.0	8282.0	WLO, Mobile, AL
831	8809.0	8285.0	WOM, Ft. Lauderdale, FL
832	8812.0	8288.0	
833	8291.0	8291.0	
836	8713.0	8113.0	WLO, Mobile, AL
837	8716.0	8128.0	KGN, Delcambre, LA
850	8291.0	8291.0	DISTRESS
851	8294.0	8294.0	8A LTD Coast/Intership
852	8297.0	8297.0	8B LTD Coast/Intership
853	8201.0	8201.0	WFN, Jeffersonville, Mississippi. River
854	8213.0	8213.0	WGK, St. Louis, Miss. River
855	8725.0	8725.0	Mississippi River
856	8737.0	8737.0	Mississippi River
1201	13077.0	12230.0	KMI, Point Reyes, CA
1202	13080.0	12233.0	KMI, Point Reyes, CA
1203	13083.0	12236.0	KMI, Point Reyes, CA
1204	13086.0	12239.0	
1205	13089.0	12242.0	
1206	13092.0	12245.0	WOM, Ft. Lauderdale, FL

FREQUENCY LISTINGS

SEA 235 VOICE FREQUENCY LISTING

VOICE CHANNEL	SHIP RECEIVE	SHIP TRANSMIT	USE
1207	13095.0	12248.0	
1208	13098.0	12251.0	WOM, Ft. Lauderdale, FL
1209	13101.0	12254.0	WOM, Ft. Lauderdale, FL
1210	13104.0	12257.0	WOO, Manahawkin, NJ
1211	13107.0	12260.0	WOO, Manahawkin, NJ
1212	13110.0	12263.0	WLO, Mobile, AL
1213	13113.0	12266.0	
1214	13116.0	12269.0	USCG, Miami/Portsmouth
1215	13119.0	12272.0	WOM, Ft. Lauderdale, FL
1216	13122.0	12275.0	
1217	13125.0	12278.0	
1218	13128.0	12281.0	
1219	13131.0	12284.0	
1220	13134.0	12287.0	
1221	13137.0	12290.0	
1222	13140.0	12293.0	
1223	13143.0	12296.0	WOM, Ft. Lauderdale, FL
1224	13146.0	12299.0	
1225	13149.0	12302.0	
1226	13152.0	12305.0	
1227	13155.0	12308.0	
1228	13158.0	12311.0	WOO, Manahawkin, NJ
1229	13161.0	12314.0	KMI, Point Reyes, CA
1230	13164.0	12317.0	WOM, Ft. Lauderdale, FL
1231	13167.0	12320.0	
1232	13170.0	12323.0	
1233	13173.0	12326.0	WLO, Mobile, AL
1234	13176.0	12329.0	
1235	13179.0	12332.0	WLO, Mobile, AL
1236	13182.0	12335.0	
1234	13176.0	12329.0	
1235	13179.0	12332.0	WLO, Mobile, AL
1236	13182.0	12335.0	KGN, Delcambre, LA
1237	13185.0	12338.0	
1238	13188.0	12341.0	
1239	13191.0	12344.0	
1240	13194.0	12347.0	
1241	13197.0	12350.0	

FREQUENCY LISTINGS

SEA 235 VOICE FREQUENCY LISTING

VOICE CHANNEL	SHIP RECEIVE	SHIP TRANSMIT	USE
1250	12290.0	12290.0	DISTRESS
1251	12353.0	12353.0	12A LTD Coast/Intership
1252	12356.0	12356.0	12B LTD Coast/Intership
1253	12359.0	12359.0	12C LTD Coast/Intership
1254	12362.0	12362.0	PUB. COAST & Miss. River
1255	12365.0	12365.0	PUB. COAST & Miss. River
1601	17242.0	16360.0	WOM, Ft. Lauderdale, FL
1602	17245.0	16363.0	KMI, Point Reyes, CA
1603	17248.0	16366.0	KMI, Point Reyes, CA
1604	17251.0	16369.0	
1605	17254.0	16372.0	WOO, Manahawkin, NJ
1606	17257.0	16375.0	
1607	17260.0	16378.0	
1608	17263.0	16381.0	
1609	17266.0	16384.0	WOM, Ft. Lauderdale, FL
1610	17269.0	16387.0	WOM, Ft. Lauderdale, FL
1611	17272.0	16390.0	WOM, Ft. Lauderdale, FL
1612	17275.0	16393.0	
1613	17278.0	16396.0	
1614	17281.0	16399.0	
1615	17284.0	16402.0	
1616	17287.0	16405.0	WOM, Ft. Lauderdale, FL
1617	17290.0	16408.0	
1618	17293.0	16411.0	
1619	17296.0	16414.0	
1620	17299.0	16417.0	WOO, Manahawkin, NJ
1621	17302.0	16420.0	
1622	17305.0	16423.0	
1623	17308.0	16426.0	
1624	17311.0	16429.0	KMI, Point Reyes, CA
1625	17314.0	16432.0	USCG, Miami, Portsmouth
1626	17317.0	16435.0	WOO, Manahawkin, NJ
1627	17320.0	16438.0	
1628	17323.0	16441.0	
1629	17326.0	16444.0	
1630	17329.0	16447.0	
1631	17332.0	16450.0	WOO, Manahawkin NJ
1632	17335.0	16453.0	

FREQUENCY LISTINGS

SEA 235 VOICE FREQUENCY LISTING

VOICE CHANNEL	SHIP RECEIVE	SHIP TRANSMIT	USE
1633	17338.0	16456.0	
1634	17341.0	16459.0	
1635	17344.0	16462.0	
1636	17347.0	16465.0	
1637	17350.0	16468.0	
1638	17353.0	16471.0	
1639	17356.0	16474.0	
1640	17359.0	16477.0	
1641	17362.0	16480.0	WLO, Mobile, AL
1642	17365.0	16483.0	
1643	17368.0	16486.0	WLO, Mobile, AL
1644	17371.0	16489.0	
1645	17374.0	16492.0	KGN, Delcambre, LA
1646	17377.0	16495.0	
1647	17380.0	16498.0	WLO, Mobile, AL
1648	17383.0	16501.0	
1649	17386.0	16504.0	
1650	16420.0	16420.0	DISTRESS
1651	16528.0	16528.0	16A LTD Coast/Intership
1652	16531.0	16531.0	16B LTD Coast/Intership
1653	16534.0	16534.0	16C LTD Coast/Intership
1654	16537.0	16537.0	
1655	16540.0	16540.0	
1656	16543.0	16543.0	PUB. COAST & Miss. River
1657	16546.0	16546.0	PUB. COAST & Miss. River
1801	19755.0	18780.0	
1802	19758.0	18783.0	
1803	19761.0	18786.0	
1804	19764.0	18789.0	
1805	19767.0	18792.0	
1806	19770.0	18795.0	
1807	19773.0	18798.0	WLO, Mobile, AL
1808	19776.0	18801.0	
1809	19779.0	18804.0	
1810	19782.0	18807.0	
1811	19785.0	18810.0	
1812	19788.0	18813.0	

FREQUENCY LISTINGS

SEA 235 VOICE FREQUENCY LISTING

VOICE CHANNEL	SHIP RECEIVE	SHIP TRANSMIT	USE
1813	19791.0	18816.0	
1814	19794.0	18819.0	
1815	19797.0	18822.0	
1851	18840.0	18840.0	18A LTD Coast/Intership
1852	18843.0	18843.0	18B LTD Coast/Intership
1853	18825.0	18825.0	
1854	18828.0	18828.0	
1855	18831.0	18831.0	
1856	18834.0	18834.0	
1857	18837.0	18837.0	
2201	22896.0	22000.0	WOO, Manahawkin, NJ
2202	22699.0	22003.0	
2203	22702.0	22006.0	
2204	22705.0	22009.0	
2205	22708.0	22012.0	WOO, Manahawkin, NJ
2206	22711.0	22015.0	
2207	22714.0	22018.0	
2208	22717.0	22021.0	
2209	22720.0	22024.0	
2210	22723.0	22027.0	WOO, Manahawkin, NJ
2211	22726.0	22030.0	
2212	22729.0	22033.0	
2213	22732.0	22036.0	
2214	22735.0	22039.0	KMI, Point Reyes, CA
2215	22738.0	22042.0	WOM, Ft. Lauderdale, FL
2216	22741.0	22045.0	WOM, Ft. Lauderdale, FL
2217	22744.0	22048.0	
2218	22747.0	22051.0	
2219	22750.0	22054.0	
2220	22753.0	22057.0	
2221	22756.0	22060.0	
2222	22759.0	22063.0	WOM, Ft. Lauderdale, FL
2223	22762.0	22066.0	KMI, Point Reyes, CA
2224	22765.0	22069.0	
2225	22768.0	22072.0	
2226	22771.0	22075.0	
2227	22774.0	22078.0	

FREQUENCY LISTINGS

SEA 235 VOICE FREQUENCY LISTING

VOICE CHANNEL	SHIP RECEIVE	SHIP TRANSMIT	USE
2228	22777.0	22081.0	KMI, Point Reyes, CA
2229	22780.0	22084.0	
2230	22783.0	22087.0	
2231	22786.0	22090.0	
2232	22789.0	22093.0	
2233	22792.0	22096.0	
2234	22795.0	22099.0	
2235	22798.0	22102.0	
2236	22801.0	22105.0	KMI, Point Reyes, CA
2237	22804.0	22108.0	WOO, Manahawkin, NJ WLO, Mobile, AL
2238	22807.0	22111.0	
2239	22810.0	22114.0	
2240	22813.0	22117.0	
2241	22816.0	22120.0	
2242	22819.0	22123.0	WLO, Mobile, AL
2243	22822.0	22126.0	
2244	22825.0	22129.0	
2245	22828.0	22132.0	
2246	22831.0	22135.0	WLO, Mobile, AL
2247	22834.0	22138.0	
2248	22837.0	22141.0	
2249	22840.0	22144.0	
2250	22843.0	22147.0	
2251	22159.0	22159.0	22A LTD Coast/Intership
2252	22162.0	22162.0	22B LTD Coast/Intership
2253	22165.0	22165.0	22C LTD Coast/Intership
2254	22168.0	22168.0	22D LTD Coast/Intership
2255	22171.0	22171.0	22E LTD Coast/Intership
2256	22174.0	22174.0	Public Coast
2257	22177.0	22177.0	Public Coast
2501	26145.0	25070.0	
2502	26148.0	25073.0	
2503	26151.0	25076.0	WLO, Mobile, AL
2504	26154.0	25079.0	
2505	26157.0	25082.0	
2506	26160.0	25085.0	

FREQUENCY LISTINGS

SEA 235 VOICE FREQUENCY LISTING

VOICE CHANNEL	SHIP RECEIVE	SHIP TRANSMIT	USE
2507	26163.0	25088.0	
2508	26166.0	25091.0	
2509	26169.0	25094.0	
2510	26172.0	25097.0	
2551	25115.0	25115.0	25A LTD Coast/Intership
2552	25118.0	25118.0	25B LTD Coast/Intership
2553	25100.0	25100.0	
2554	25103.0	25103.0	
2555	25106.0	25106.0	
2556	25109.0	25109.0	
2557	25112.0	25112.0	

DSC EMERGENCY CALLING FREQUENCIES

2187.5	2187.5	DSC EMER CALLING
4207.5	4207.5	DSC EMER CALLING
6312.0	6312.0	DSC EMER CALLING
8414.5	8414.5	DSC EMER CALLING
12577.0	12577.0	DSC EMER CALLING
16804.5	16804.5	DSC EMER CALLING

FREQUENCY LISTINGS

SEA 235 TELEX FREQUENCY LISTING

TELEX CHANNEL	SHIP RECEIVE	SHIP TRANSMIT	USE
401	4210.5	4172.5	WNU
402	4211.0	4173.0	ZLA
403	4211.5	4173.5	KFS
404	4212.0	4174.0	
405	4212.5	4174.5	WLO
406	4213.0	4175.0	WLO, VIP
407	4213.5	4175.5	KBS
408	4214.0	4176.0	KLB, WPD
409	4214.5	4176.6	KLC
410	4215.0	4177.0	WLO
411	4177.5	4177.5	NBDP EMER CALLING
412	4215.5	4178.0	KBS
413	4216.0	4178.5	KPH
414	4216.5	4179.0	WCC
415	4217.0	4179.5	WLO
416	4217.5	4180.0	VCT
417	4218.0	4180.5	WLO
418	4218.5	4181.0	
419	4219.0	4181.5	
471	4202.5	4202.5	
472	4203.0	4203.0	
473	4203.5	4203.5	
474	4204.0	4204.0	
475	4204.5	4204.5	
476	4205.0	4205.0	
477	4205.5	4205.5	
478	4206.0	4206.0	
479	4206.5	4206.5	
480	4207.0	4207.0	
601	6314.5	6263.0	KFS
602	6315.0	6263.5	WNU
603	6315.5	6264.0	KFS
604	6316.0	6264.5	
605	6316.5	6265.0	
606	6317.0	6265.5	WLO
607	6317.5	6266.0	
608	6318.0	6266.5	KLB

FREQUENCY LISTINGS

SEA 235 TELEX FREQUENCY LISTING

TELEX CHANNEL	SHIP RECEIVE	SHIP TRANSMIT	USE
609	6318.5	6267.0	KLC
610	6319.0	6267.5	WLO
611	6268.0	6268.0	NBDP EMER CALLING
612	6319.5	6268.5	
613	6320.0	6269.0	KPH
614	6320.5	6269.5	
615	6521.0	6270.0	WLO
616	6321.5	6270.5	
617	6322.0	6271.0	KLC
618	6322.5	6271.5	
619	6323.0	6272.0	WLO
620	6323.5	6272.5	
621	6324.0	6273.0	WCC
622	6324.5	62736	KPH, KLC
623	6325.0	6274.0	
624	6325.5	6274.5	
625	6326.0	6275.0	
626	6326.5	6275.5	
627	6327.0	6281.0	
628	6327.5	6281.5	
629	6328.0	6282.0	
630	6328.5	6282.5	
631	6329.0	6283.0	
632	6329.5	6283.5	
633	6330.0	6284.0	
634	6330.5	6284.5	
671	6300.5	6300.5	
672	6301.0	6301.0	
673	6301.5	6301.5	
674	6302.0	6302.0	
675	6302.5	6302.5	
676	6303.0	6303.0	
677	6303.5	6303.5	
678	6304.0	6304.0	
679	6304.5	6304.5	
680	6305.0	6305.0	
681	6305.5	6305.5	
682	6306.0	6306.0	

FREQUENCY LISTINGS

SEA 235 TELEX FREQUENCY LISTING

TELEX CHANNEL	SHIP RECEIVE	SHIP TRANSMIT	USE
683	6306.5	6306.5	
684	6307.0	6307.0	
685	6307.5	6307.5	
686	6308.0	6308.0	
687	6308.5	6308.5	
688	6309.0	6309.0	
689	6309.5	6309.5	
690	6310.0	6310.0	
691	6310.5	6310.5	
692	6311.0	6311.0	
693	6311.5	6311.5	
801	8376.5	8376.5	NBDP EMER CALLING
802	8417.0	8377.0	WNU
803	8417.5	8377.5	KFS
804	8418.0	8378.0	
805	8418.5	8378.5	WLO
806	8419.0	8379.0	WLO
807	8419.5	8379.5	
808	8420.0	8380.0	
809	8420.5	8380.5	KLC
810	8421.0	8381.0	WLO
811	8421.5	8381.5	WLO
812	8422.0	8382.0	
813	8422.5	8382.5	KPH
814	8423.0	8383.0	
815	8423.5	8383.5	WLO
816	8424.0	8384.0	WCC
817	8424.5	8384.5	KLC
818	8425.0	8385.0	KLB
819	8425.5	8385.5	
820	8426.0	8386.0	
821	8426.5	8386.5	WCC
822	8427.0	8387.0	KLC
823	8427.5	8387.5	
824	8428.0	8388.0	
825	8428.5	8388.5	
826	8429.0	8389.0	WLO
827	8429.5	8389.5	

FREQUENCY LISTINGS

SEA 235 TELEX FREQUENCY LISTING

TELEX CHANNEL	SHIP RECEIVE	SHIP TRANSMIT	USE
828	8430.0	8390.0	
829	8430.5	8390.5	
830	8431.0	8391.0	
831	8431.5	8391.5	
832	8432.0	8392.0	
833	8432.5	8392.5	
834	8433.0	8393.0	
835	8433.5	8393.5	
836	8434.0	8394.0	
837	8434.5	8394.5	
838	8435.0	8395.0	
839	8435.5	8395.5	
840	8436.0	8396.0	
871	8396.5	8396.5	
872	8397.0	8397.0	
873	8397.5	8397.5	
874	8398.0	8398.0	
875	8398.5	8398.5	
876	8399.0	8399.0	
877	8399.5	8399.5	
878	8400.0	8400.0	
879	8400.5	8400.5	
880	8401.0	8401.0	
881	8401.5	8401.5	
882	8402.0	8402.0	
883	8402.5	8402.5	
884	8403.0	8403.0	
885	8403.5	8403.5	
886	8404.0	8404.0	
887	8404.5	8404.5	
888	8405.0	8405.0	
889	8405.5	8405.5	
890	8406.0	8406.0	
891	8406.5	8406.5	
892	8407.0	8407.0	
893	8407.5	8407.5	
894	8408.0	8408.0	
895	8408.5	8408.5	

FREQUENCY LISTINGS

SEA 235 TELEX FREQUENCY LISTING

TELEX CHANNEL	SHIP RECEIVE	SHIP TRANSMIT	USE
896	8409.0	8409.0	
897	8409.5	8409.5	
898	8410.0	8410.0	
899	8410.5	8410.5	
900	8411.0	8411.0	
901	8411.5	8411.5	
902	8412.0	8412.0	
903	8412.5	8412.5	
904	8413.0	8413.0	
905	8413.5	8413.5	
906	8414.0	8414.0	
1201	12579.5	12477.0	
1202	12580.0	12477.5	ZLA
1203	12580.5	12478.0	KFS
1204	12581.0	12478.5	
1205	12581.5	12479.0	WLO
1206	12582.0	12479.5	VIP
1207	12582.5	12480.0	
1208	12583.0	12480.5	
1209	12583.5	12481.0	KLC
1210	12584.0	12481.5	VIP
1211	12584.5	12482.0	WLO
1212	12585.0	12482.5	
1213	12585.5	12483.0	KPH
1214	12586.0	12483.5	
1215	12586.5	12484.0	WLO
1216	12587.0	12484.5	
1217	12587.5	12485.0	KLC
1218	12588.0	12485.5	
1219	12588.5	12486.0	WNU
1220	12589.0	12486.5	
1221	12589.5	12487.0	WCC
1222	12590.0	12487.5	KLC
1223	12590.5	12488.0	KLB
1224	12591.0	12488.5	
1225	12591.5	12489.0	WLO
1226	12592.0	12489.5	
1227	12592.5	12490.0	

FREQUENCY LISTINGS**SEA 235 TELEX FREQUENCY LISTING**

TELEX CHANNEL	SHIP RECEIVE	SHIP TRANSMIT	USE
1228	12593.0	12490.5	
1229	12593.5	12491.0	WLO
1230	12594.0	12491.5	
1231	12594.5	12492.0	
1232	12595.0	12492.5	
1233	12595.5	12493.0	
1234	12596.0	12493.5	WLO
1235	12596.5	12494.0	
1236	12597.0	12494.5	
1237	12597.5	12495.0	
1238	12598.0	12495.5	WCC
1239	12598.5	12496.0	
1240	12599.0	12496.5	WLO
1241	12599.5	12497.0	
1242	12600.0	12497.5	KPH
1243	12600.5	12498.0	
1244	12601.0	12498.5	
1245	12601.5	12499.0	
1246	12602.0	12499.5	
1247	12602.5	12500.0	
1248	12603.0	12500.5	KLC
1249	12603.5	12501.0	
1250	12604.0	12501.5	WLO
1251	12604.5	12502.0	WLO
1252	12605.0	12502.5	
1253	12605.5	12503.0	
1254	12606.0	12503.5	WLO
1255	12606.5	12504.0	
1256	12807.0	12504.5	
1257	12607.5	12505.0	WNU
1258	12608.0	12505.5	
1259	12608.5	12506.0	
1260	12609.0	12506.5	
1261	12609.5	12507.0	
1262	12610.0	12507.5	
1263	12610.5	12508.0	VCT
1264	12611.0	12508.5	
1265	12611.5	12509.0	KEJ
1266	12612.0	12509.5	

FREQUENCY LISTINGS

SEA 235 TELEX FREQUENCY LISTING

TELEX CHANNEL	SHIP RECEIVE	SHIP TRANSMIT	USE
1267	12612.5	12510.0	
1268	12613.0	12510.5	
1269	12613.5	12511.0	
1270	12614.0	12511.5	
1271	12614.5	12512.0	
1272	12615.0	12512.5	
1273	12615.5	12513.0	
1274	12616.0	12513.5	
1275	12616.5	12514.0	
1276	12617.0	12514.5	
1277	12617.5	12515.0	
1278	12618.0	12515.5	
1279	12618.5	12516.0	
1280	12619.0	12516.5	
1281	12619.5	12517.0	
1282	12620.0	12517.5	
1283	12620.5	12518.0	
1284	12621.0	12518.5	
1285	12621.5	12519.0	
1286	12622.0	12519.5	
1287	12520.0	12520.0	NBDP EMER CALLING
1288	12622.5	12520.5	
1289	12623.0	12521.0	
1290	12623.5	12521.5	
1291	12624.0	12522.0	SAB
1292	12624.5	12522.5	
1293	12625.0	12523.0	
1294	12625.5	12523.5	
1295	12626.0	12524.0	
1296	12626.5	12524.5	
1297	12627.0	12525.0	
1298	12627.5	12525.5	
1299	12628.0	12526.0	
1300	12628.5	12526.5	
1301	12629.0	12527.0	
1302	12629.5	12527.5	
1303	12630.0	12528.0	
1304	12630.5	12528.5	
1305	12631.0	12529.0	

FREQUENCY LISTINGS

SEA 235 TELEX FREQUENCY LISTING

TELEX CHANNEL	SHIP RECEIVE	SHIP TRANSMIT	USE
1306	12631.5	12529.5	
1307	12632.0	12530.0	
1308	12632.5	12530.5	
1309	12633.0	12531.0	
1310	12633.5	12531.5	
1311	12634.0	12532.0	
1312	12634.5	12532.5	
1313	12635.0	12533.0	
1314	12635.5	12533.5	
1315	12636.0	12534.0	
1316	12636.5	12534.5	
1317	12637.0	12535.0	
1318	12637.5	12535.5	
1319	12638.0	12536.0	
1320	12638.5	12536.5	
1321	12639.0	12537.0	
1322	12639.5	12537.5	
1323	12640.0	12538.0	
1324	12640.5	12538.5	
1325	12641.0	12539.0	
1326	12641.5	12539.5	
1327	12642.0	12540.0	
1328	12642.5	12540.5	
1329	12643.0	12541.0	
1330	12643.5	12541.5	
1331	12644.0	12542.0	
1332	12644.5	12542.5	
1333	12645.0	12543.0	
1334	12645.5	12543.5	
1335	12646.0	12544.0	
1336	12646.5	12544.5	
1337	12647.0	12545.0	
1338	12647.5	12545.5	
1339	12648.0	12546.0	
1340	12648.5	12546.5	
1341	12649.0	12547.0	
1342	12649.5	12547.5	
1343	12650.0	12548.0	
1344	12650.5	12548.5	

FREQUENCY LISTINGS**SEA 235 TELEX FREQUENCY LISTING**

TELEX CHANNEL	SHIP RECEIVE	SHIP TRANSMIT	USE
1345	12651.0	12549.0	
1346	12651.5	12549.5	
1347	12652.0	12555.0	
1348	12652.5	12555.5	
1349	12653.0	12556.0	
1350	12653.5	12556.5	
1351	12654.0	12557.0	
1352	12654.5	12557.5	
1353	12655.0	12558.0	
1354	12655.5	12558.5	
1355	12656.0	12559.0	
1356	12656.5	12559.5	
1371	12560.0	12560.0	
1372	12560.5	12560.5	
1373	12561.0	12561.0	
1374	12561.5	12561.5	
1375	12562.0	12562.0	
1376	12562.5	12562.5	
1377	12563.0	12563.0	
1378	12563.5	12563.5	
1379	12564.0	12564.0	
1380	12564.5	12564.5	
1381	12565.0	12565.0	
1382	12565.5	12565.5	
1383	12566.0	12566.0	
1384	12566.5	12566.5	
1385	12567.0	12567.0	
1386	12567.5	12567.5	
1387	12568.0	12568.0	
1388	12568.5	12568.5	
1389	12569.0	12569.0	
1390	12569.5	12569.5	
1391	12570.0	12570.0	
1392	12570.5	12570.5	
1393	12571.0	12571.0	
1394	12571.5	12571.5	
1395	12572.0	12572.0	
1396	12572.5	12572.5	

FREQUENCY LISTINGS

SEA 235 TELEX FREQUENCY LISTING

TELEX CHANNEL	SHIP RECEIVE	SHIP TRANSMIT	USE
1397	12573.0	12573.0	
1398	12573.5	12573.5	
1399	12574.0	12574.0	
1400	12574.5	12574.5	
1401	12575.0	12575.0	
1402	12575.5	12575.5	
1403	12576.0	12576.0	
1404	12576.5	12576.5	
1601	16807.0	16683.5	
1602	16807.5	16684.0	ZLA
1603	16808.0	16684.5	KFS
1604	16808.5	16685.0	KLB
1605	16809.0	16685.5	WLO
1606	16809.5	16686.0	VIP
1607	16810.0	16686.5	
1608	16810.5	16687.0	
1609	16811.0	16687.5	KLC
1610	16811.5	16688.0	VIP
1611	16812.0	16688.5	WLO
1612	16812.5	16689.0	
1613	16813.0	16689.5	KPH
1614	16813.5	16690.0	
1615	18814.0	16690.5	WLO
1616	16814.5	16691.0	
1617	16815.0	16691.5	KLC
1618	16815.5	16692.0	
1619	16816.0	16692.5	WNU
1620	16816.5	16693.0	
1621	16817.0	16693.5	
1622	16817.5	16694.0	KPH, KLC
1623	16818.0	16694.5	
1624	16695.0	16695.0	NBDP EMER CALLING
1625	16818.5	16695.5	WLO
1626	16819.0	16696.0	
1627	16819.5	16696.5	
1628	16820.0	16697.0	
1629	16820.5	16697.5	WLO
1630	16821.0	16698.0	

FREQUENCY LISTINGS**SEA 235 TELEX FREQUENCY LISTING**

TELEX CHANNEL	SHIP RECEIVE	SHIP TRANSMIT	USE
1631	16821.5	16698.5	
1632	16822.0	16699.0	
1633	16822.5	16699.5	
1634	16823.0	16700.0	
1635	16823.5	16700.5	
1636	16824.0	16701.0	
1637	16824.5	16701.5	
1638	16825.0	16702.0	WCC
1639	16825.5	16702.5	
1640	16826.0	16703.0	WLO
1641	16826.5	16703.5	
1642	16827.0	16704.0	
1643	16827.5	16704.5	
1644	16828.0	16705.0	WLO
1645	16828.5	16705.5	
1646	16829.0	16706.0	
1647	16829.5	16706.5	KFS
1648	16830.0	16707.0	KLC
1649	16830.5	16707.5	
1650	16831.0	16708.0	WLO
1651	16831.5	16708.5	
1652	16832.0	16709.0	WNU
1653	16832.5	16709.5	
1654	16833.0	16710.0	WLO
1655	16833.5	16710.5	
1656	16834.0	16711.0	
1657	16834.5	16711.5	WNU
1658	16835.0	16712.0	
1659	16835.5	16712.5	
1660	16836.0	16713.0	
1661	16836.5	16713.5	
1662	16837.0	16714.0	
1663	16837.5	16714.5	
1664	16838.0	16715.0	
1665	16838.5	16715.5	
1666	16839.0	16716.0	
1667	16839.5	16716.5	
1668	16840.0	16717.0	
1669	16840.5	16717.5	

FREQUENCY LISTINGS

SEA 235 TELEX FREQUENCY LISTING

TELEX CHANNEL	SHIP RECEIVE	SHIP TRANSMIT	USE
1670	16841.0	16718.0	
1671	16841.5	16718.5	
1672	16842.0	16719.0	
1673	16842.5	16719.5	KEJ
1674	16843.0	16720.0	
1675	16843.5	16720.5	
1676	16844.0	16721.0	VCT
1677	16844.5	16721.5	
1678	16845.0	16722.0	
1679	16845.5	16722.5	
1680	16846.0	16723.0	
1681	16846.5	16723.5	
1682	16847.0	16724.0	
1683	16847.5	16724.5	
1684	16848.0	16725.0	
1685	16848.5	16725.5	
1686	16849.0	16726.0	
1687	16849.5	16726.5	
1688	16850.0	16727.0	
1689	16850.5	16727.5	
1690	16851.0	16728.0	
1691	16851.5	16728.5	SAB
1692	16852.0	16729.0	
1693	16852.5	16729.5	
1694	16853.0	16730.0	
1695	16853.5	16730.5	
1696	16854.0	16731.0	
1697	16854.5	16731.5	
1698	16855.0	16732.0	
1699	16855.5	16732.5	
1700	16856.0	16733.0	
1701	16856.5	16733.5	
1702	16857.0	16739.0	
1703	16857.5	16739.5	
1704	16858.0	16740.0	
1705	16858.5	16740.5	
1706	16859.0	16741.0	
1707	16859.5	16741.5	
1708	16860.0	16742.0	

FREQUENCY LISTINGS**SEA 235 TELEX FREQUENCY LISTING**

TELEX CHANNEL	SHIP RECEIVE	SHIP TRANSMIT	USE
1709	16860.5	16742.5	
1710	16861.0	16743.0	
1711	16861.5	16743.5	
1712	16862.0	16744.0	
1713	16862.5	16744.5	
1714	16863.0	16745.0	
1715	16863.5	16745.5	
1716	16864.0	16746.0	
1717	16864.5	16746.5	
1718	16865.0	16747.0	
1719	16865.5	16747.5	
1720	16866.0	16748.0	
1721	16866.5	16748.5	
1722	16867.0	16749.0	
1723	16867.5	16749.5	
1724	16868.0	16750.0	
1725	18868.5	16750.5	
1726	16869.0	16751.0	
1727	16869.5	16751.5	
1728	16870.0	16752.0	
1729	16870.5	16752.5	
1730	16871.0	16753.0	
1731	16871.5	16753.5	
1732	16872.0	16754.0	
1733	16872.5	16754.5	
1734	16873.0	16755.0	
1735	16873.5	16755.5	
1736	16874.0	16756.0	
1737	16874.5	16756.5	
1738	16875.0	16757.0	
1739	18875.5	16757.5	
1740	16876.0	16758.0	
1741	16876.5	16758.5	
1742	16877.0	16759.0	
1743	16877.5	16759.5	
1744	16878.0	16760.0	
1745	16878.5	16760.5	
1746	16879.0	16761.0	
1747	16879.5	16761.5	

FREQUENCY LISTINGS

SEA 235 TELEX FREQUENCY LISTING

TELEX CHANNEL	SHIP RECEIVE	SHIP TRANSMIT	USE
1748	16880.0	16762.0	
1749	16880.5	16762.5	
1750	16881.0	16763.0	
1751	16881.5	16763.5	
1752	16882.0	16764.0	
1753	16882.5	16764.5	
1754	16883.0	16765.0	
1755	16883.5	16765.5	
1756	16884.0	16766.0	
1757	16884.5	16766.5	
1758	16885.0	16767.0	
1759	16885.5	16767.5	
1760	16886.0	16768.0	
1761	16886.5	16768.5	
1762	16887.0	16769.0	
1763	16887.5	16769.5	
1764	16886.0	16770.0	
1765	16888.5	16770.5	
1766	16889.0	16771.0	
1767	16889.5	16771.5	
1768	16890.0	16772.0	
1769	16890.5	16772.5	
1770	16891.0	16773.0	
1771	16891.5	16773.5	
1772	16892.0	16774.0	
1773	16892.5	16774.5	
1774	16893.0	16775.0	
1775	16893.5	16775.5	
1776	16894.0	16776.0	
1777	16894.5	16776.5	
1778	16895.0	16777.0	
1779	16895.5	16777.5	
1780	16896.0	16778.0	
1781	16896.5	16778.5	
1782	16897.0	16779.0	
1783	16897.5	16779.5	
1784	16898.0	16780.0	
1785	16898.5	16780.5	
1786	16899.0	16781.0	

FREQUENCY LISTINGS**SEA 235 TELEX FREQUENCY LISTING**

TELEX CHANNEL	SHIP RECEIVE	SHIP TRANSMIT	USE
1787	16899.5	16781.5	
1788	16900.0	16782.0	
1789	16900.5	16782.5	
1790	16901.0	16783.0	
1791	16901.5	16783.5	
1792	16902.0	16784.0	
1793	16902.5	16784.5	
1794	16796.5	16796.5	
1795	16797.0	16797.0	
1796	16797.5	16797.5	
1797	16798.0	16798.0	
1798	16798.5	16798.5	
1799	16799.0	16799.0	
1800	16799.5	16799.5	
1801	19681.0	18870.5	
1802	19681.5	18871.0	
1803	19682.0	18871.5	
1804	19682.5	18872.0	
1805	19683.0	18872.5	
1806	19683.5	18873.0	
1807	19684.0	18873.5	
1808	19684.5	18874.0	
1809	19685.0	18874.5	
1810	19685.5	18875.0	
1811	19686.0	18875.5	
1812	19686.5	18876.0	
1813	19687.0	18876.5	
1814	19687.5	18877.0	
1815	19688.0	18877.5	
1816	19688.5	18878.0	
1817	19689.0	18878.5	
1818	19689.5	18879.0	
1819	19690.0	18879.5	
1820	19690.5	18880.0	
1821	19691.0	18880.5	
1822	19691.5	18881.0	
1823	19692.0	18881.5	
1824	19692.5	18882.0	

FREQUENCY LISTINGS

SEA 235 TELEX FREQUENCY LISTING

TELEX CHANNEL	SHIP RECEIVE	SHIP TRANSMIT	USE
1825	19693.0	18882.5	
1826	19693.5	18883.0	
1827	19694.0	18883.5	
1828	19694.5	18884.0	
1829	19695.0	18884.5	
1830	19695.5	18885.0	
1831	19696.0	18885.5	
1832	19696.5	18886.0	
1833	19697.0	18886.5	
1834	19697.5	18887.0	
1835	19698.0	18887.5	
1836	19698.5	18888.0	
1837	19699.0	18888.5	
1838	19699.5	18889.0	
1839	19700.0	18889.5	
1840	19700.5	18890.0	
1841	19701.0	18890.5	
1842	19701.5	18891.0	
1843	19702.0	18891.5	
1844	19702.5	18892.0	
1845	19703.0	18892.5	
1871	18893.0	18893.0	
1872	18893.5	18893.5	
1873	18894.0	18894.0	
1874	18894.5	18894.5	
1875	18895.0	18895.0	
1876	18895.5	18895.5	
1877	18896.0	18896.0	
1878	18896.5	18896.5	
1879	18897.0	18897.0	
1880	18897.5	18897.5	
1881	18898.0	18898.0	
2201	22376.5	22284.5	
2202	22377.0	22285.0	WNU
2203	22377.5	22285.5	KFS
2204	22378.0	22286.0	
2205	22378.5	22286.5	

FREQUENCY LISTINGS

SEA 235 TELEX FREQUENCY LISTING

TELEX CHANNEL	SHIP RECEIVE	SHIP TRANSMIT	USE
2206	22379.0	22287.0	
2207	22379.5	22287.5	
2208	22380.0	22288.0	
2209	22380.5	22288.5	KLC
2210	22381.0	22289.0	WLO
2211	22381.5	22289.5	
2212	22382.0	22290.0	
2213	22382.5	22290.5	KPH
2214	22383.0	22291.0	
2215	22383.5	22291.5	WLO
2216	22384.0	22292.0	
2217	22384.5	22292.5	KLC
2218	22385.0	22293.0	
2219	22385.5	22293.5	WNU
2220	22386.0	22294.0	
2221	22386.5	22294.5	WCC
2222	22387.0	22295.0	KLC
2223	22387.5	22295.5	
2224	22388.0	22296.0	
2225	22388.5	22296.5	
2226	22389.0	22297.0	
2227	22389.5	22297.5	
2228	22390.0	22298.0	
2229	22390.5	22298.5	
2230	22391.0	22299.0	
2231	22391.5	22299.5	
2232	22392.0	22300.0	
2233	22392.5	22300.5	
2234	22393.0	22301.0	
2235	22393.5	22301.5	
2236	22394.0	22302.0	
2237	22394.5	22302.5	
2238	22395.0	22303.0	KPH
2239	22395.5	22303.5	
2240	22396.0	22304.0	KLB
2241	22396.5	22304.5	
2242	22397.0	22305.0	
2243	22397.5	22305.5	
2244	22398.0	22306.0	

FREQUENCY LISTINGS

SEA 235 TELEX FREQUENCY LISTING

TELEX CHANNEL	SHIP RECEIVE	SHIP TRANSMIT	USE
2245	22398.5	22306.5	
2246	22399.0	22307.0	
2247	22399.5	22307.5	
2248	22400.0	22308.0	KLC
2249	22400.5	22308.5	
2250	22401.0	22309.0	
2251	22401.5	22309.5	
2252	22402.0	22310.0	WNU
2253	22402.5	22310.5	
2254	22403.0	22311.0	WLO
2255	22403.5	22311.5	
2256	22404.0	22312.0	WLO
2257	22404.5	22312.5	WNU
2258	22405.0	22313.0	
2259	22405.5	22313.5	
2260	22406.0	22314.0	WLO
2261	22406.5	22314.5	
2262	22407.0	22315.0	WLO
2263	22407.5	22315.5	
2264	22408.0	22316.0	
2265	22408.5	22316.5	
2266	22409.0	22317.0	
2267	22409.5	22317.5	
2268	22410.0	22318.0	
2269	22410.5	22318.5	
2270	22411.0	22319.0	
2271	22411.5	22319.5	
2272	22412.0	22320.0	
2273	22412.5	22320.5	
2274	22413.0	22321.0	
2275	22413.5	22321.5	
2276	22414.0	22322.0	
2277	22414.5	22322.5	
2278	22415.0	22323.0	
2279	22415.5	22323.5	
2280	22416.0	22324.0	
2281	22416.5	22324.5	
2282	22417.0	22325.0	
2283	22417.5	22325.5	

FREQUENCY LISTINGS**SEA 235 TELEX FREQUENCY LISTING**

TELEX CHANNEL	SHIP RECEIVE	SHIP TRANSMIT	USE
2284	22418.0	22326.0	
2285	22418.5	22326.5	
2286	22419.0	22327.0	
2287	22419.5	22327.5	
2288	22420.0	22328.0	
2289	22420.5	22328.5	
2290	22421.0	22329.0	
2291	22421.5	22329.5	
2292	22422.0	22330.0	
2293	22422.5	22330.5	
2294	22423.0	22331.0	
2295	22423.5	22331.5	
2296	22424.0	22332.0	
2297	22424.5	22332.5	
2298	22425.0	22333.0	
2299	22425.5	22333.5	
2300	22426.0	22334.0	
2301	22426.5	22334.5	
2302	22427.0	22335.0	
2303	22427.5	22335.5	
2304	22428.0	22336.0	
2305	22428.5	22336.5	
2306	22429.0	22337.0	
2307	22429.5	22337.5	
2308	22430.0	22338.0	
2309	22430.5	22338.5	
2310	22431.0	22339.0	
2311	22431.5	22339.5	
2312	22432.0	22340.0	
2313	22432.5	22340.5	
2314	22433.0	22341.0	
2315	22433.5	22341.5	
2316	22434.0	22342.0	
2317	22434.5	22342.5	
2318	22435.0	22343.0	
2319	22435.5	22343.5	
2320	22436.0	22344.0	
2321	22436.5	22344.5	
2322	22437.0	22345.0	

FREQUENCY LISTINGS

SEA 235 TELEX FREQUENCY LISTING

TELEX CHANNEL	SHIP RECEIVE	SHIP TRANSMIT	USE
2323	22437.5	22345.5	
2324	22438.0	22346.0	
2325	22438.5	22346.5	
2326	22439.0	22347.0	
2327	22439.5	22347.5	
2328	22440.0	22348.0	
2329	22440.5	22348.5	
2330	22441.0	22349.0	
2331	22441.5	22349.5	
2332	22442.0	22350.0	
2333	22442.5	22350.5	
2334	22443.0	22351.0	
2335	22443.5	22351.5	
2371	22352.0	22352.0	
2372	22352.5	22352.5	
2373	22353.0	22353.0	
2374	22353.5	22353.5	
2375	22354.0	22354.0	
2376	22354.5	22354.5	
2377	22355.0	22355.0	
2378	22355.5	22355.5	
2379	22356.0	22356.0	
2380	22356.5	22356.5	
2381	22357.0	22357.0	
2382	22357.5	22357.5	
2383	22358.0	22358.0	
2384	22358.5	22358.5	
2385	22359.0	22359.0	
2386	22359.5	22359.5	
2387	22360.0	22360.0	
2388	22360.5	22360.5	
2389	22361.0	22361.0	
2390	22361.5	22361.5	
2391	22362.0	22362.0	
2392	22362.5	22362.5	
2393	22363.0	22363.0	
2394	22363.5	22363.5	
2395	22364.0	22364.0	

FREQUENCY LISTINGS**SEA 235 TELEX FREQUENCY LISTING**

TELEX CHANNEL	SHIP RECEIVE	SHIP TRANSMIT	USE
2396	22364.5	22364.5	
2397	22365.0	22365.0	
2398	22365.5	22365.5	
2399	22366.0	22366.0	
2400	22366.5	22366.5	
2401	22367.0	22367.0	
2402	22367.5	22367.5	
2403	22368.0	22368.0	
2404	22368.5	22368.5	
2405	22369.0	22369.0	
2406	22369.5	22369.5	
2407	22370.0	22370.0	
2408	22370.5	22370.5	
2409	22371.0	22371.0	
2410	22371.5	22371.5	
2411	22372.0	22372.0	
2412	22372.5	22372.5	
2413	22373.0	22373.0	
2414	22373.5	22373.5	
2501	26101.0	25173.0	WLO
2502	26101.5	25173.5	
2503	26102.0	25174.0	
2504	26102.5	25174.5	
2505	26103.0	25175.0	
2506	26103.5	25175.5	
2507	26104.0	25176.0	
2508	26104.5	25176.5	
2509	26105.0	25177.0	
2510	26105.5	25177.5	
2511	26106.0	25178.0	
2512	26106.5	25178.5	
2513	26107.0	25179.0	
2514	26107.5	25179.5	
2515	26108.0	25180.0	
2516	26108.5	25180.5	
2517	26109.0	25181.0	
2518	26109.5	25181.5	
2519	26110.0	25182.0	

FREQUENCY LISTINGS

SEA 235 TELEX FREQUENCY LISTING

TELEX CHANNEL	SHIP RECEIVE	SHIP TRANSMIT	USE
2520	26110.5	25182.5	
2521	26111.0	25183.0	
2522	26111.5	25183.5	
2523	26112.0	25184.0	
2524	26112.5	25184.5	
2525	26113.0	25185.0	
2528	26113.5	25185.5	
2527	26114.0	25186.0	
2528	26114.5	25186.5	
2529	26115.0	25187.0	
2530	26115.5	25187.5	
2531	26116.0	25188.0	
2532	26116.5	25188.5	
2533	26117.0	25189.0	
2534	26117.5	25189.5	
2535	26118.0	25190.0	
2536	26118.5	25190.5	
2537	26119.0	25191.0	
2538	26119.5	25191.5	
2539	26120.0	25192.0	
2540	26120.5	25192.5	
2415	22374.0	22374.0	
2571	25193.0	25193.0	
2572	25193.5	25193.5	
2573	25194.0	25194.0	
2574	25194.5	25194.5	
2575	25195.0	25195.0	
2576	25195.5	25195.5	
2577	25196.0	25196.0	
2578	25196.5	25196.5	
2579	25197.0	25197.0	
2580	25197.5	25197.5	
2581	25198.0	25198.0	
2582	25198.5	25198.5	
2583	25199.0	25199.0	
2584	25199.5	25199.5	
2585	25200.0	25200.0	
2586	25200.5	25200.5	

FREQUENCY LISTINGS**SEA 235 TELEX FREQUENCY LISTING**

TELEX CHANNEL	SHIP RECEIVE	SHIP TRANSMIT	USE
2587	25201.0	25201.0	
2588	25201.5	25201.5	
2589	25202.0	25202.0	
2590	25202.5	25202.5	
2591	25203.0	25203.0	
2592	25203.5	25203.5	
2593	25204.0	25204.0	
2594	25204.5	25204.5	
2595	25205.0	25205.0	
2596	25205.5	25205.5	
2597	25206.0	25206.0	
2598	25206.5	25206.5	
2599	25207.0	25207.0	
2600	25207.5	25207.5	
2601	25208.0	25208.0	

FREQUENCY LISTINGS**COAST STATIONS PROVIDING TELEX SERVICE**

<u>CALL SIGN</u>	<u>STATION</u>	<u>SELCALL #</u>
KBS	Dutch Harbor, AK	1115
KLB	Seattle, WA	1113
KPH	San Francisco, CA	1091
KLC	Galveston, TX	1101
WLO	Mobile, AL	1090
WPD	Tampa, FL	1102
WCC	Chatham, MA	1092
VCT	St. Johns, Newfoundland, Canada	1094
KEJ	Hawaii, Pacific Ocean	1094
KFS	Palo Alto (San Francisco, CA)	1094
SAB	Gothenburg, Sweden	1094
ZLA	Awanui, New Zealand	1094
VIP	Perth, Western Australia	1094
WNU	Slidell, New Orleans, LA	1094

FREQUENCY LISTINGS**SEA SCRATCH PAD MEMORY LISTING**

<u>BIN #</u>	<u>RX FREQUENCY</u>	<u>TX FREQUENCY</u>	<u>MODE</u>	<u>NAME TAG</u>
1	2500.0	---	TAM	[WWV 1]
2	5000.0	---	TAM	[WWV 2]
3	10000.0	---	TAM	[WWV 3]
4	15000.0	---	TAM	[WWV 4]
5	20000.0	---	TAM	[WWV 5]
6	2182.0	2182.0	USB	[EMER]
7	2142.0	2142.0	USB	[SAFTY 2]
8	4125.0	4125.0	USB	[SAFTY 4]
9	6215.0	6215.0	USB	[SAFTY 6]
10	8291.0	8291.0	USB	[SAFTY 8]
11	12290.0	12290.0	USB	[SAFTY12]
12	16420.0	16420.0	USB	[SAFTY16]
13	2450.0	2003.0	USB	[KMI 242]
14	2506.0	2406.0	USB	[KMI 248]
15	4357.0	4065.0	USB	[KMI 401]
16	4402.0	4110.0	USB	[KMI 416]
17	4405.0	4113.0	USB	[KMI 417]
18	8728.0	8204.0	USB	[KMI 804]
19	8743.0	8219.0	USB	[KMI 809]
20	8782.0	8258.0	USB	[KMI 822]
21	13077.0	12230.0	USB	[KMI1201]
22	13080.0	12233.0	USB	[KMI1202]
23	13083.0	12236.0	USB	[KMI1203]
24	17245.0	16363.0	USB	[KMI1602]
25	17248.0	16366.0	USB	[KMI1603]
26	17311.0	16429.0	USB	[KMI1624]
27	22735.0	22039.0	USB	[KMI2214]
28	22762.0	22066.0	USB	[KMI2223]
29	22777.0	22081.0	USB	[KMI2228]
30	22801.0	22105.0	USB	[KMI2236]
31	2490.0	2031.5	USB	[WOM 209]
32	2514.0	2118.0	USB	[WOM 221]
33	2566.0	2390.0	USB	[WOM 245]
34	2442.0	2406.0	USB	[WOM 247]

FREQUENCY LISTINGS**SEA SCRATCH PAD MEMORY LISTING**

<u>BIN #</u>	<u>RX FREQUENCY</u>	<u>TX FREQUENCY</u>	<u>MODE</u>	<u>NAME TAG</u>
35	4363.0	4071.0	USB	[WOM 403]
36	4390.0	4098.0	USB	[WOM 412]
37	4405.0	4113.0	USB	[WOM 417]
38	4423.0	4131.0	USB	[WOM 423]
39	8722.0	8198.0	USB	[WOM 802]
40	8731.0	8207.0	USB	[WOM 805]
41	8746.0	8222.0	USB	[WOM 810]
42	8758.0	8234.0	USB	[WOM 814]
43	8791.0	8267.0	USB	[WOM 825]
44	8809.0	8285.0	USB	[WOM 831]
45	13092.0	12245.0	USB	[WOM1206]
46	13098.0	12251.0	USB	[WOM1208]
47	13101.0	12254.0	USB	[WOM1209]
48	13119.0	12272.0	USB	[WOM1215]
49	13143.0	12296.0	USB	[WOM1223]
50	13164.0	12317.0	USB	[WOM1230]
51	17242.0	16360.0	USB	[WOM1601]
52	17266.0	16384.0	USB	[WOM1609]
53	17269.0	16387.0	USB	[WOM1610]
54	17272.0	16390.0	USB	[WOM1611]
55	17287.0	16405.0	USB	[WOM1616]
56	22738.0	22042.0	USB	[WOM2215]
57	22741.0	22045.0	USB	[WOM2216]
58	22759.0	22063.0	USB	[WOM2222]
59	2558.0	2166.0	USB	[WOO 232]
60	2450.0	2366.0	USB	[WOO 242]
61	4384.0	4092.0	USB	[WOO 410]
62	4387.0	4095.0	USB	[WOO 411]
63	4402.0	4110.0	USB	[WOO 416]
64	4420.0	4128.0	USB	[WOO 422]
65	8740.0	8216.0	USB	[WOO 808]
66	8749.0	8225.0	USB	[WOO 811]
67	8761.0	8237.0	USB	[WOO 815]
68	8794.0	8270.0	USB	[WOO 826]

FREQUENCY LISTINGS**SEA SCRATCH PAD MEMORY LISTING**

<u>BIN #</u>	<u>RX FREQUENCY</u>	<u>TX FREQUENCY</u>	<u>MODE</u>	<u>NAME TAG</u>
69	13083.0	12236.0	USB	[WOO1203]
70	13104.0	12257.0	USB	[WOO1210]
71	13107.0	12260.0	USB	[WOO1211]
72	13158.0	12311.0	USB	[WOO1228]
73	17254.0	16372.0	USB	[WOO1605]
74	17299.0	16417.0	USB	[WOO1620]
75	17317.0	16435.0	USB	[WOO1626]
76	17332.0	16450.0	USB	[WOO1631]
77	22696.0	22000.0	USB	[WOO2201]
78	22708.0	22012.0	USB	[WOO2205]
79	22723.0	22027.0	USB	[WOO2210]
80	22801.0	22105.0	USB	[WOO2236]
81	2065.0	2065.0	USB	[BUSOP 1]
82	2079.0	2079.0	USB	[BUSOP 2]
83	2096.5	2096.5	USB	[BUSOP 3]
84	3023.0	---	USB	[BUSOP 4]
85	4125.0	4125.0	USB	[BUSOP 5]
86	4146.0	4146.0	USB	[BUSOP 6]
87	4149.0	4149.0	USB	[BUSOP 7]
88	4417.0	4417.0	USB	[BUSOP 8]
89	5680.0	---	USB	[BUSOP 9]
90	6224.0	6224.0	USB	[BUSOP10]
91	6227.0	6227.0	USB	[BUSOP11]
92	6230.0	6230.0	USB	[BUSOP12]
93	6518.0	6516.0	USB	[BUSOP13]
94	8294.0	8294.0	USB	[BUSOP14]
95	8297.0	8297.0	USB	[BUSOP15]
96	12353.0	12353.0	USB	[BUSOP16]
97	12356.0	12356.0	USB	[BUSOP17]
98	12359.0	12359.0	USB	[BUSOP18]
99	16528.0	16528.0	USB	[BUSOP19]
100	16531.0	16531.0	USB	[BUSOP20]
101	16534.0	16534.0	USB	[BUSOP21]
102	18840.0	18840.0	USB	[BUSOP22]

FREQUENCY LISTINGS

SEA SCRATCH PAD MEMORY LISTING

<u>BIN #</u>	<u>RX FREQUENCY</u>	<u>TX FREQUENCY</u>	<u>MODE</u>	<u>NAME TAG</u>
103	18843.0	18843.0	USB	[BUSOP23]
104	22159.0	22159.0	USB	[BUSOP24]
105	22162.0	22162.0	USB	[BUSOP25]
106	22165.0	22165.0	USB	[BUSOP26]
107	22168.0	22168.0	USB	[BUSOP27]
108	22171.0	22171.0	USB	[BUSOP28]
109	25115.0	25115.0	USB	[BUSOP29]
110	25118.0	25118.0	USB	[BUSOP30]
111	4344.1	---	USB	[PACWFX1]
112	8680.1	---	USB	[PACWFX2]
113	12728.1	---	USB	[PACWFX3]
114	4853.1	---	USB	[HIWFX 1]
115	9980.6	---	USB	[HIWFX 2]
116	11088.1	---	USB	[HIWFX 3]
117	16133.1	---	USB	[HIWFX 4]
118	21783.1	---	USB	[HIWFX 5]
119	8502.0	---	USB	[CGWFX 1]
120	12748.1	---	USB	[CGWFX 2]
121	4317.9	---	USB	[VAWFX 1]
122	8078.1	---	USB	[VAWFX 2]
123	10863.1	---	USB	[VAWFX 3]
124	12788.0	---	USB	[GLFWFX1]
125	17146.4	---	USB	[GLFWFX2]
126	3355.1	---	USB	[ATLWFX1]
127	9108.1	---	USB	[ATLWFX2]
128	15957.1	---	USB	[ATLWFX3]
129	20013.1	---	USB	[ATLWFX4]
130	6338.6	---	USB	[MAWFX 1]
131	8492.1	---	USB	[AKWFX 1]
132	5451.1	---	USB	[CAWFX 1]
133	9088.1	---	USB	[CAWFX 2]
134	4266.1	---	USB	[BCWFX 2]
135	6454.1	---	USB	[BCWFX 3]
136	12751.1	---	USB	[BCWFX 4]

FREQUENCY LISTINGS**SEA SCRATCH PAD MEMORY LISTING**

<u>BIN #</u>	<u>RX FREQUENCY</u>	<u>TX FREQUENCY</u>	<u>MODE</u>	<u>NAME TAG</u>
137	4269.1	---	USB	[NSWFX 1]
138	6495.1	---	USB	[NSWFX 2]
139	10534.1	---	USB	[NSWFX 3]
140	13508.1	---	USB	[NSWFX 4]
141	13282.0	---	USB	[HIVWX 1]
142	13270.0	---	USB	[NYVWX 1]
143	2054.0	2054.0	USB	[SHIP 1]
144	2065.0	2065.0	USB	[SHIP 2]
145	2079.0	2079.0	USB	[SHIP 3]
146	2082.5	2082.5	USB	[SHIP 4]
147	2086.0	2086.0	USB	[SHIP 5]
148	2093.0	2093.0	USB	[SHIP 6]
149	2096.5	2096.5	USB	[SHIP 7]
150	2115.0	2115.0	USB	[SHIP 8]
151	2134.0	2134.0	USB	[SHIP 9]
152	2638.0	2638.0	USB	[SHIP 10]
153	2738.0	2738.0	USB	[SHIP 11]
154	2118.0	2118.0	USB	[SHPCAN1]
155	2003.0	2003.0	USB	[ALSKA 1]
156	2006.0	2006.0	USB	[ALSKA 2]
157	2182.0	2182.0	USB	[ALSKA 3]
158	2203.0	2203.0	USB	[ALSKA 4]
159	2419.0	2419.0	USB	[ALSKA 5]
160	2422.0	2422.0	USB	[ALSKA 6]
161	2427.0	2427.0	USB	[ALSKA 7]
162	2430.0	2430.0	USB	[ALSKA 8]
163	2447.0	2447.0	USB	[ALSKA 9]
164	2450.0	2450.0	USB	[ALSKA10]
165	2479.0	2479.0	USB	[ALSKA11]
166	2482.0	2482.0	USB	[ALSKA12]
167	2506.0	2506.0	USB	[ALSKA13]
168	2509.0	2509.0	USB	[ALSKA14]
169	2527.0	2527.0	USB	[ALSKA15]
170	2535.0	2535.0	USB	[ALSKA16]

FREQUENCY LISTINGS

SEA SCRATCH PAD MEMORY LISTING

<u>BIN #</u>	<u>RX FREQUENCY</u>	<u>TX FREQUENCY</u>	<u>MODE</u>	<u>NAME TAG</u>
171				
172				
173				
174				
175				
176				
177				
178				
179				
180				
181				
182				
183				
184				
185				
186				
187				
188				
189				
190				
191				
192				
193				
194				
195				
196				
197				
198				
199				
200				

FREQUENCY LISTINGS

SEA SCRATCH PAD WORKSHEET

<u>BIN #</u>	<u>RX FREQUENCY</u>	<u>TX FREQUENCY</u>	<u>MODE</u>	<u>NAME TAG</u>
--------------	-------------------------	-------------------------	-------------	-----------------

SSB PROPAGATION TABLES

TYPICAL FREQUENCY PROPAGATION: SPRING AND SUMMER

BAND	4 MHz		8 MHz		12 MHz		16 MHz		22 MHz	
	Min	Max	Min	Max	Min	Max	Min	Max	Min	Max
Propagation (Miles)										
Hours after sunset										
1	50	250	200	1000	500	3500	750	6000	1500	7000
2	100	600	250	1500	500	3500	750	6000		
3	100	600	250	2000	500	3500				
4	100	800	250	2500						
5	100	1000	250	2500						
6	100	1500	400	3000						
7	100	1500	500	3500						
8	250	2000	750	4000						
9	250	2500	750	4000						
10	250	2500	750	4000						
11	100	1000	500	2500						
Hours after sunrise										
1	100	500	400	2000						
2	0	100	400	2000						
3	0	100	250	1500						
4	0	100	250	1500	500	1000				
5	0	100	250	1500	500	1500				
6	0	100	250	1500	500	2500	750	4000		
7	0	100	250	2500	500	3500	750	4000	1500	7000
8	0	100	250	1500	500	3500	750	4000	1500	7000
9	0	100	250	1500	500	3500	750	4000	1500	7000
10	0	100	250	1500	500	3500	750	4000	1500	7000
11	0	100	150	500	500	3500	750	6000	1500	7000
12	0	200	150	500	500	3500	750	6000	1500	7000
13	50	250	150	750	500	3500	750	6000	1500	7000

FREQUENCY LISTINGS

SSB PROPAGATION TABLES

TYPICAL FREQUENCY PROPAGATION: FALL AND WINTER

BAND	4 MHz		8 MHz		12 MHz		16 MHz		22 MHz	
	Min	Max	Min	Max	Min	Max	Min	Max	Min	Max
Propagation (Miles)										
Hours after sunset										
1	100	600	400	2000	500	3500	750	6000	1500	7000
2	100	800	400	2000	500	4000	750	6000		
3	100	1000	400	2000	500	4000				
4	100	1000	400	2500	500	4000				
5	100	1000	400	3000	500	4000				
6	100	1500	400	3500						
7	250	2000	400	4000						
8	250	2500	500	4000						
9	500	3000	500	4000						
10	500	4000	500	4000						
11	500	3000	750	5000						
12	250	2500	750	5000						
13	250	1500	500	2500						
Hours after sunrise										
1	100	1000	400	2000						
2	100	500	400	2000						
3	0	100	400	2000	500	3500	750	4000		
4	0	100	400	2000	500	3500	750	4000	1500	3000
5	0	100	250	1500	500	3500	750	4000	1500	4000
6	0	100	250	1500	500	3500	750	4000	1500	5000
7	0	100	250	1500	500	4000	750	5000	1500	6000
8	0	100	250	1500	500	4000	750	5000	1500	7000
9	0	100	250	1500	500	4000	750	6000	1500	7000
10	0	100	250	1000	500	3500	750	6000	1500	7000
11	0	250	250	1500	500	3500	750	6000	1500	7000

REAR PANEL CONNECTIONS

POWER CONNECTOR:

Connect to a power supply that delivers 12 volts DC and is capable of 30 Amps intermittent current.

RF CONNECTOR:

Type UHF female connector for interconnecting a 50 ohm coax to the antenna system. Coax type should be RG-58C/U, RG-213/U or equivalent using a PL-259 UHF plug.

SEABUSS INTERFACE - P1:

Interconnect for connecting the optional SEA 2350 remote controller(s). Standard SEABUSS interconnect cable is used and up to 150 feet (50 meters) of cable is permitted between the SEA 235 and the SEA 2350 controller(s).

Pins 1 and 9 - System common ground. Used for DC power return and termination of shield braids.

Pin 2 - 13.6S terminal. Switched 13.6 volts from the transceiver to controller.

Pin 3 - PTT line for radiotelephone. Connecting this terminal to ground places the radiotelephone in transmit.

Pins 4 and 5 - Balanced data lines. Approximately RS485 format, differential logic. Use a shielded, twisted pair.

Pins 6 and 7 - Balanced, bi-directional audio lines. Nominal audio level is approximately 1 volt peak-to-peak. Use a shielded twisted pair.

Pin 8 PWR buss. This is the ON-OFF control line from the controller to the radiotelephone power control circuitry. Momentarily grounding this line will “toggle” the power control circuitry in the SEA 235 to the opposite state.

DB-9 COMPUTER INTERFACE - P2:

A 6-pole dip switch, located inside the SEA 235 on the mainboard, is used to disconnect all lines EXCEPT the RS232 serial connections when operation with a computer is intended. When the switches 2 through 5 are in the ON position, the DB-9 connector is configured as an RS232 based SEABUSS interface and is compatible with E-Mail systems like GLOBELINK and PINOAK DIGITAL.

The default switch position for all switches is OFF.

Pin 1 - Internal switch ON allows the radio to be turned ON and OFF when a momentary ground is applied. (SW1-1).

Pin 2 - RXD Serial data RECEIVER pin for RS232 port.

Pin 3 - TXD Serial data TRANSMITTER pin for RS232 port.

Pin 4 - Internal switch ON allows the radio to go into transmit when a ground is applied. (SW1-4).

Pin 5 - RS232 port ground pin.

REAR PANEL

REAR PANEL CONNECTIONS (cont.)

Pin 6 - Internal switch ON allows unscquelched audio to be present at this pin. Equivalent to LLAF on Accessory connector P3. (SW1-2).

Pin 7 - Internal switch ON allows transmit audio to enter the radio. Equivalent to TXAF on Accessory connector P3. (SW1-3).

Pin 8 - Internal switch ON allows 13.6 volts to be present when the radio is turned on. (SW1-6). **DO NOT EXCEED 3 AMPS.**

Pin 9 - Internal switch ON supplies extra ground pin. (SW1-5).

NOTE: *The SEA 235 is shipped with internal switches in the OFF position. This will allow a general purpose RS232 port on Pins 3,4 and 5 and removes all other connections to the remaining DB-9 pins. It is possible to damage any external accessories, the SEA 235 or both when the switches are set incorrectly!*

PARALLEL INTERFACE - P3:

Use for interconnecting additional equipment requiring accesses to the radio transmit and receive circuitry along with tuner connections.

GND- (Pins 1 and 7) Provides access to the negative side (ground) of the primary supply. Also common to chassis.

PTT- (Pin 2) Applying a ground potential to this connection activates the transmitter.

MIC- (Pin 3) Auxiliary input for a dynamic microphone.

HANDSET - (Pin 4) Handset receiver audio. 600 ohms.

AF-(Pin 5) AC coupled output of the audio power amplifier. Speaker impedance required is 3.2 ohms or greater.

SPKR (Pin 6) Internal speaker input. A jumper to the AF terminal is required to operate the internal speaker.

13.6S (Pin 8) 13.6 volts, switched. Normally used to power an external antenna tuner such as the SEA 1635 or SEA 1612C. **DO NOT EXCEED 3 AMPS.** Fused with a 5 amp fuse located on the PA/Filter board.

TND (Pin 9) Input signal from the tuner to indicate a “matched” antenna. Grounding this line will cause the “TND” indicator to display.

DMD TUNE (Pin 10) This output terminal provides the connection to operate the “DEMAND TUNE” function in the SEA 1635 and SEA 1612C.

LLAF (Pin 11) Low level receiver audio output (unscquelched). Configured for unbalanced 300 ohm lines, nominal output level is 1 volt peak-to-peak.

TXAF (Pin 12) Input for an alternative transmitter audio source such as a MODEM. Configured for unbalanced 600 ohm lines. Nominal input level for full modulation is 1 volt peak-to-peak.

DEFINITIONS

This manual assumes basic HF SSB radiotelephone knowledge. Below are definitions of acronyms used in the operating instructions.

AF: **A**udio **F**requency

AGC: Used in the receiver of a radio, the **A**utomatic **G**ain **C**ontrol adjusts the radio circuitry to compensate for large and small signals.

ALC: **A**utomatic **L**evel **C**ontrol keeps the transmit power from overshooting.

AME: Only used for 2182.0 KHz, **A**mplitude **M**odulation **E**quivalent allows a single side band radio to be intelligently heard on an older AM marine radio.

Bin / Channel: A number assigned to a pair (transmit / receive) of frequencies stored in the radio memory. While both are pre programmed, for the purpose of this manual, '**Channels**' are permanent in memory and can not be changed by the operator. '**Bins**' are channels that can be programmed by the operator.

Carrier: A reference frequency for a channel. Normally 0 Watts for SSB transmissions. AME uses a 40 Watt carrier and R3J uses a 5 Watt carrier.

DSC: **D**igital **S**elective **C**alling is a more advanced NECODE system.

DUPLEX: A channel using different transmit and receive frequencies.

ITU: **I**nternational **T**elecommunications **U**ion.

KHz: **K**ilo (thousand) **H**ertz. Commonly used when referring to a single HF frequency such as 2182.0 KHz.

LSB: The opposite of USB is **L**ower **S**ide **B**and and not allowed for marine use.

MHz: **M**ega (million) **H**ertz. Typically used when referring to a band of frequencies such as '4 MHz band'.

NECODE: A signaling device for calling a specific station also using NECODE.

PTT: **P**ush **T**o **T**alk refers to the microphone button.

R.I.T.: **R**eceiver **I**ncremental **T**uning allows changing the receiver frequency.

SQUELCH: A circuit that mutes the speaker when no signal is present.

SSB: **S**ingle **S**ide **B**and. The carrier is removed along with one sideband.

TELEX: Data communications that requires a special modem connected to a computer and the radio. Abbreviated as TLX or TLX-GW for Globe Wireless.

TUNER: Also known as a coupler, this device matches the antenna to the radio for maximum radiated power.

USB: The modulation method for a marine HF SSB radio is **U**pper **S**ide **B**and.

VOGAD: a **V**oice **O**perated **G**ain **A**djustment **D**evice used in the microphone audio circuit.

VSWR: **V**oltage **S**tanding **W**ave **R**atio, this measurement figure helps determine how well the radio is matched to the antenna system.



A UNIT OF DATAMARINE INTERNATIONAL INC.

7030 220th St. S.W.
Mountlake Terrace, Washington 98043 USA
425-771-2182 FAX: 425-771-2650
<http://www.sea-dmi.com>