

PRICE \$2.00

HEATH COMPANY • BENTON HARBOR, MICHIGAN

HEATHKIT® ASSEMBLY MANUAL



Copyright © 1968
Heath Company
All rights reserved

AC POWER SUPPLY

MODEL HP-23A

TYPICAL COMPONENT TYPES

This chart is a guide to commonly used types of electronic components. The symbols and related illustrations

should prove helpful in identifying most parts and reading the schematic diagrams.

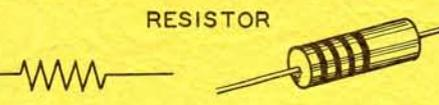
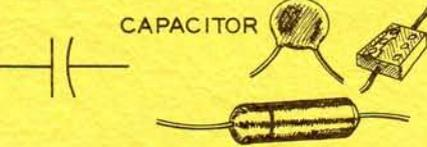
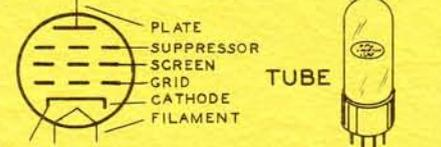
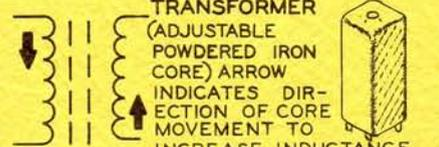
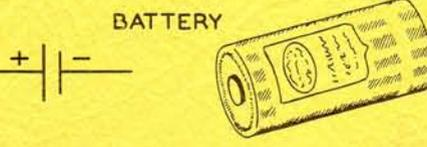
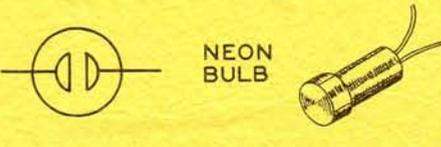
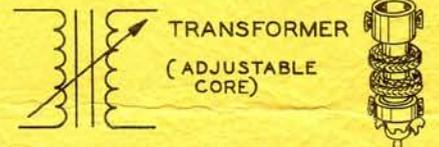
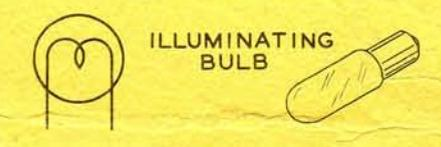
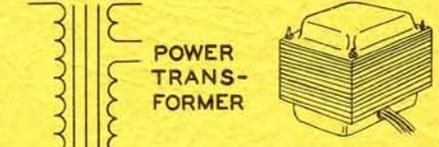
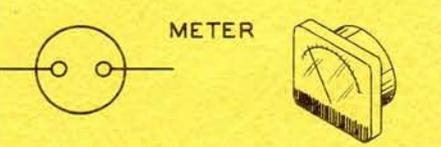
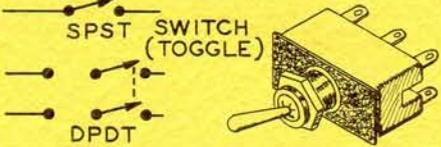
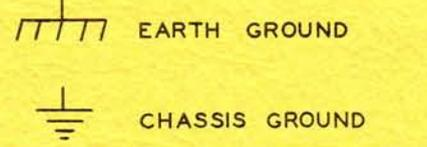
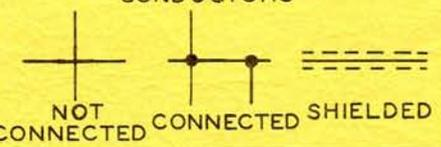
<p style="text-align: center;">RESISTOR</p> 	<p style="text-align: center;">CAPACITOR</p> 	<p style="text-align: center;">TUBE</p> 
<p style="text-align: center;">POTENTIOMETER (CONTROL)</p> 	<p style="text-align: center;">ELECTROLYTIC CAPACITOR</p> 	<p style="text-align: center;">TRANSISTOR</p> 
<p style="text-align: center;">TRANSFORMER (IRON CORE)</p> 	<p style="text-align: center;">VARIABLE CAPACITOR</p> 	<p style="text-align: center;">RECTIFIER (DIODE)</p> 
<p style="text-align: center;">TRANSFORMER (ADJUSTABLE POWDERED IRON CORE) ARROW INDICATES DIR- ECTION OF CORE MOVEMENT TO INCREASE INDUCTANCE</p> 	<p style="text-align: center;">BATTERY</p> 	<p style="text-align: center;">NEON BULB</p> 
<p style="text-align: center;">TRANSFORMER (ADJUSTABLE CORE)</p> 	<p style="text-align: center;">PHONO JACK</p> 	<p style="text-align: center;">ILLUMINATING BULB</p> 
<p style="text-align: center;">POWER TRANS- FORMER</p> 	<p style="text-align: center;">PHONE JACK</p> 	<p style="text-align: center;">METER</p> 
<p style="text-align: center;">INDUCTOR (COIL)</p> 	<p style="text-align: center;">RECEPTACLE</p> 	<p style="text-align: center;">SPST SWITCH (TOGGLE) DPDT</p> 
<p style="text-align: center;">PIEZOELECTRIC CRYSTAL</p> 	<p style="text-align: center;">SPEAKER</p> 	<p style="text-align: center;">SWITCH (ROTARY)</p> 
<p style="text-align: center;">BINDING POST</p> 	<p style="text-align: center;">MICROPHONE</p> 	<p style="text-align: center;">FUSE</p> 
<p style="text-align: center;">ANTENNA GENERAL LOOP</p> 	<p style="text-align: center;">EARTH GROUND CHASSIS GROUND</p> 	<p style="text-align: center;">CONDUCTORS NOT CONNECTED CONNECTED SHIELDED</p> 

Assembly
and
Operation
of the



**AC POWER SUPPLY
MODEL HP-23A**



TABLE OF CONTENTS

Introduction.	2
Parts List.	3
Step-By-Step Assembly	
Chassis Parts Mounting.	4
Transformer Wiring.	7
Chassis Wiring.	7
Component Installation.	8
Final Wiring.	10
Final Assembly.	11
Initial Tests.	12
Operation.	13
In Case Of Difficulty.	14
Troubleshooting Chart.	15
Specifications.	16
Circuit Description.	17
Schematic (fold-out from page).	17
Chassis Photograph.	18
Replacement Parts Price List.	19

INTRODUCTION

The Heathkit Model HP-23A AC Power Supply is designed to provide all the necessary operating voltages for fixed station operation of Heathkit amateur radio transceivers. The versatility and many features of this Power Supply also make it ideal for use with many other types of amateur radio equipment.

The Power Supply features a high voltage source, a choice of two low voltage sources, fixed and adjustable bias sources, and 6.3 and 12.6 volt filament sources. Extensive filtering and good regulation is provided for the DC sources. The power transformer has a dual primary winding which can be connected for operation from either 120 or 240 VAC power lines.

A series connection is provided at the power output socket to permit turning the Power Supply on or off remotely from the equipment with which it is used. A toggle switch on the Power

Supply is used to select the value of low B+ voltage available at the output socket. The switch also will turn off the Power Supply. A circuit breaker in the primary circuit provides overload and short circuit protection.

All output voltage connections from the Power Supply are made through the power output socket on the chassis. This provides an easy means of rapidly changing the equipment from mobile to fixed station operation.

Refer to the Kit Builders Guide for complete information on unpacking, parts identification, tools, wiring, soldering and step-by-step assembly procedures.

PARTS LIST

NOTE: The numbers in parentheses are keyed to the numbers on the Parts Pictorial (fold-out from Page 3).

PART No.	PARTS Per Kit	DESCRIPTION	PART No.	PARTS Per Kit	DESCRIPTION
RESISTORS			MISCELLANEOUS		
(1)1-9-1	2	10 k Ω 1 watt (brown-black-orange)	(13)10-57	1	10 k Ω tab-mount control
(2)1-15-2	1	1 k Ω 2 watt (brown-black-red)	(14)57-27	7	Silicon diode
1-24-2	5	100 k Ω 2 watt (brown-black-yellow)	(15)431-40	1	4-lug terminal strip
			(16)431-55	1	6-lug terminal strip
			(17)481-1	2	Metal capacitor mounting wafer
			481-3	2	Phenolic capacitor mounting wafer
			(18)438-29	1	11-pin plug
			(19)440-1	1	Plug cap
			(20)434-118	1	11-pin socket
			(21)435-1	1	Socket mounting ring
			(22)61-12	1	DPDT toggle switch
			(23)65-17	1	Circuit breaker
			(24)73-1	1	3/8" grommet
			(25)73-4	1	5/16" grommet
			54-198	1	Power transformer
			46-22	1	Filter choke
			200-505	1	Chassis
			205-168-1	1	Bottom plate
			100-538-1	1	Cabinet shell
			(26)261-6	4	Rubber foot
			347-18	1	8-wire cable
			346-1	1	Black sleeving
			89-19	1	Line cord
			391-34	1	Blue and white label
			490-5	1	Nut starter
			331-6		Solder
			597-260	1	Parts Order Form
			597-308	1	Kit Builders Guide
			595-924	1	Manual
CAPACITORS					
(3)25-19	2	20 μ F electrolytic			
25-36	1	40 μ F electrolytic			
(4)25-34	4	125 μ F tab-mount electrolytic			
HARDWARE					
#6 Hardware					
(5)250-8	8	#6 x 3/8" sheet metal screw			
(6)250-89	8	6-32 x 3/8" screw			
(7)252-3	8	6-32 nut			
(8)254-1	9	#6 lockwasher			
#8 Hardware					
(9)250-137	6	8-32 x 3/8" screw			
(10)252-4	10	8-32 nut			
(11)254-2	10	#8 lockwasher			
(12)259-2	2	#8 solder lug			

PARTS PICTORIAL

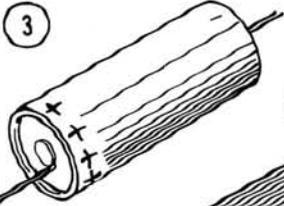
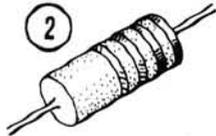

SIZE
MAY VARY

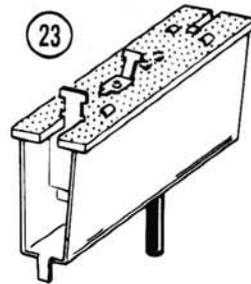
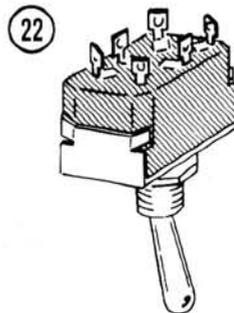
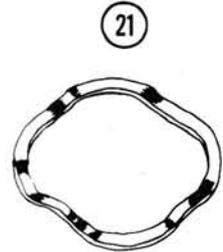
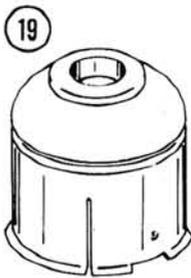
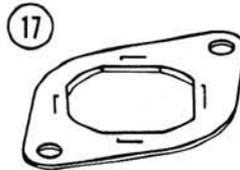
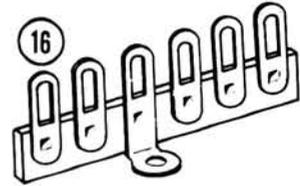
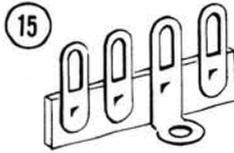
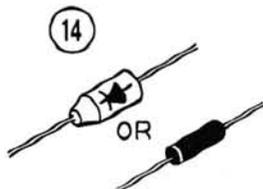
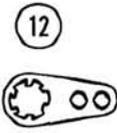
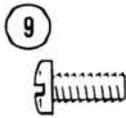
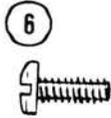
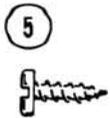

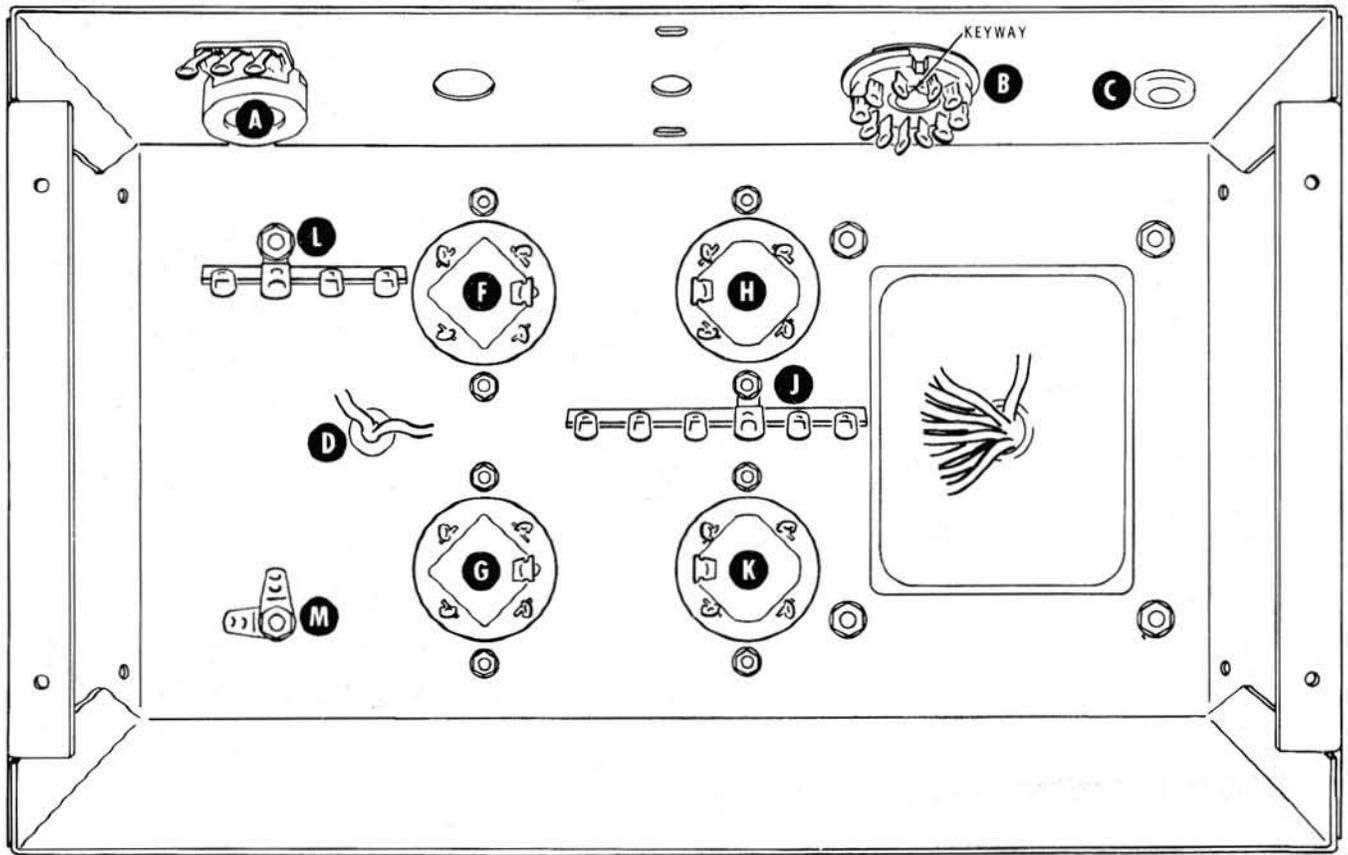

PICTORIAL 1

STEP-BY-STEP ASSEMBLY

NOTE: Before you begin to assemble this kit, refer to the Kit Builders Guide for complete information on wiring, soldering and step-by-step assembly procedures.

As you perform a step in the Step-By-Step Assembly, first read the step completely through. Then perform the operation as directed. Position each part and wire as shown in the Pictorial that accompanies the series of steps. The Details provide specific information for individual steps.

Lockwashers and nuts will be used with most screws when mounting parts, unless the step directs otherwise. Consequently, only the size and type of hardware to be used will generally be called out in a step. For example, the phrase "Use 6-32 x 3/8" hardware" means to use a 6-32 x 3/8" screw, one or more #6 lockwashers, and a 6-32 nut. Refer to the Details associated with the step for the proper installation of the hardware and the correct number of lockwashers.

CHASSIS PARTS MOUNTING

Refer to Pictorial 1 for the following steps.

- () Install the 10 k Ω tab-mount control at A on the chassis as shown in Detail 1A. Position the control lugs as shown in Pictorial 1. Secure the control by bending the tabs against the chassis as shown.

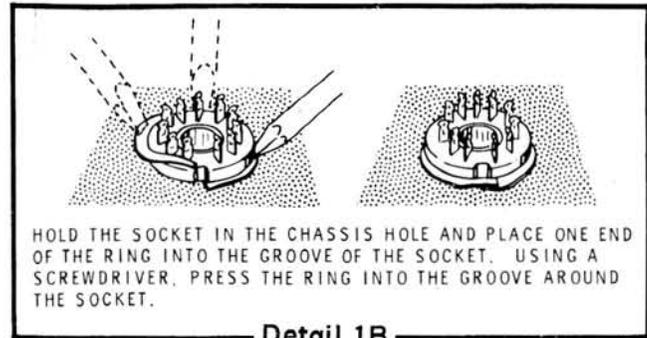
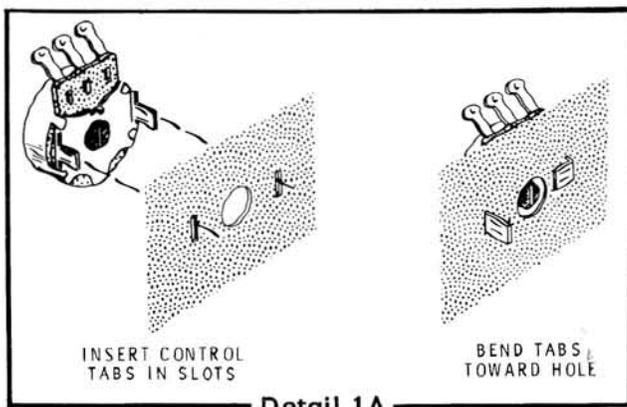

- () Refer to Detail 1B and mount the 11-pin socket at B with the keyway positioned as shown. Use the socket mounting ring.
- () Install the 3/8" grommet in hole C.
- () Install the 5/16" grommet in hole D.

NOTE: The Heath Company has provided a plastic nut starter with this kit. Use this nut starter to hold and start 6-32 nuts on screws. Refer to Page 3 of the Kit Builders Guide.

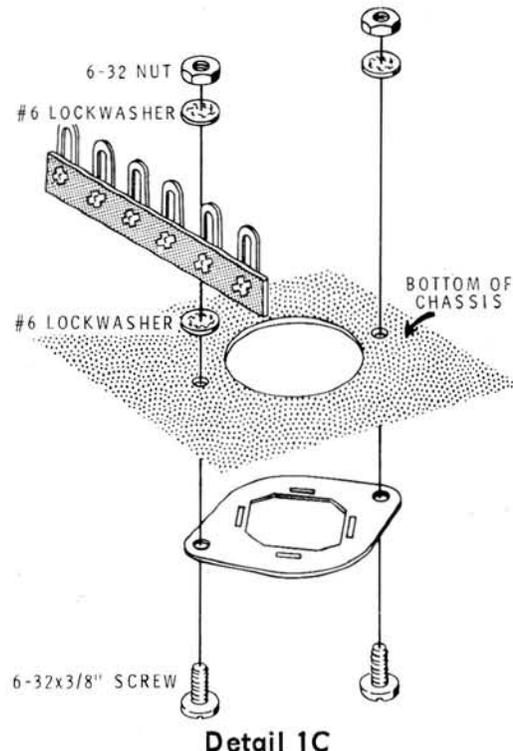

NOTE: To insure a good ground connection, on the underside of the chassis scrape away a small amount of paint around the mounting holes for the solder lugs at M, the terminal strip at L, and the two holes each for capacitors H and K.

- () Refer to Detail 1C and install a metal capacitor mounting wafer at H and a 6-lug terminal strip at J. Install the mounting wafer on the top of the chassis and the terminal strip under the chassis. Use 6-32 x 3/8" hardware. Position the terminal strip as shown in the Pictorial. Be sure to use two lockwashers with all terminal strips.
- () Mount the other metal capacitor mounting wafer on top of the chassis at K. Use 6-32 x 3/8" hardware.
- () In like manner, mount phenolic capacitor mounting wafers on top of the chassis at F and G. Use 6-32 x 3/8" hardware.
- () Refer to Detail 1D and prepare the mounting foot of a 4-lug terminal strip. Cut the front of the foot with diagonal cutters, then spread the cut until an 8-32 screw will fit through the hole. This terminal strip will be mounted with the filter choke in the following steps.

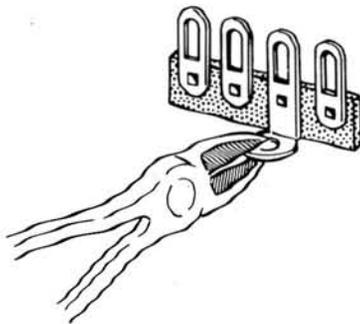

Detail 1D

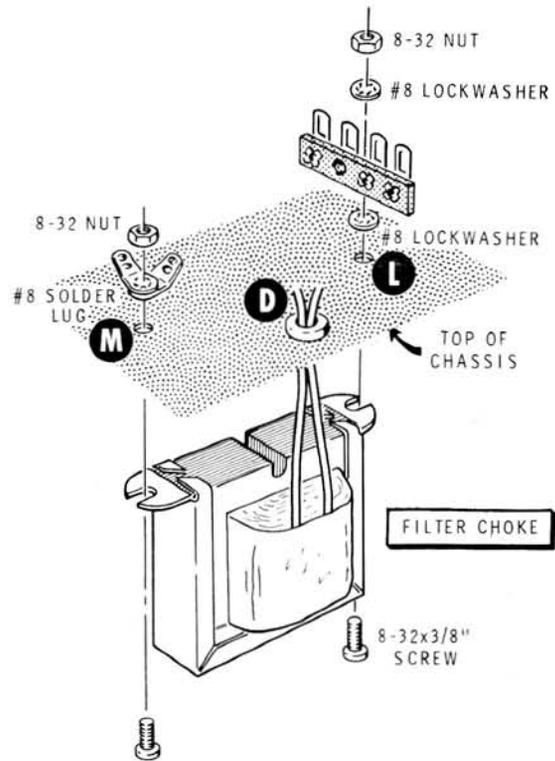

Detail 1E

- () Cut both leads of the filter choke to a length of 4-1/2", and remove 1/4" of insulation from the cut end of each. Measure the leads from where they leave the choke. Apply a small amount of solder to the end of each lead after cutting.
- () Refer to Detail 1E and position the filter choke on top of the chassis with its leads through grommet D. Mount the choke with 8-32 x 3/8" hardware at L and M, with the prepared 4-lug terminal strip at L and two #8 solder lugs at M. Be sure to use two lockwashers with the terminal strip. Position the solder lugs and terminal strip as shown. Bend the end of the solder lugs up away from the chassis.



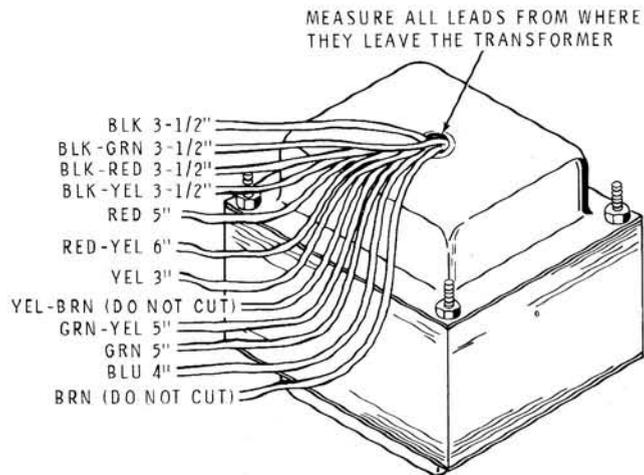

Detail 1F

NOTE: Use the scale on the fold-out from Page 9 for measuring wires in the following step.

- () Refer to Detail 1F and cut the Power Transformer leads to the following lengths (measured from where they leave the transformer):

WIRE COLOR	LENGTH
Black	3-1/2"
Black-green	3-1/2"
Black-red	3-1/2"
Black-yellow	3-1/2"
Red	5"
Red-yellow	6"
Yellow	3"
Yellow-brown	do not cut
Green-yellow	5"
Green	5"
Blue	4"
Brown	do not cut

- () Remove 1/4" of insulation from the end of each cut transformer lead, and melt a small amount of solder on the bared end to hold the wire strands together.
- () Mount the power transformer in the large cutout on the chassis as shown in Detail 1G. Use #8 lockwashers and 8-32 nuts.
- () Refer to Detail 1H and install 125 μ F tab-mount electrolytic capacitors in the mounting wafers at F, G, H, and K. Insert the capacitor lugs into the wafers, making sure that the connecting lug of each capacitor is oriented as shown in the Pictorial. Then twist each mounting lug 1/8 turn.

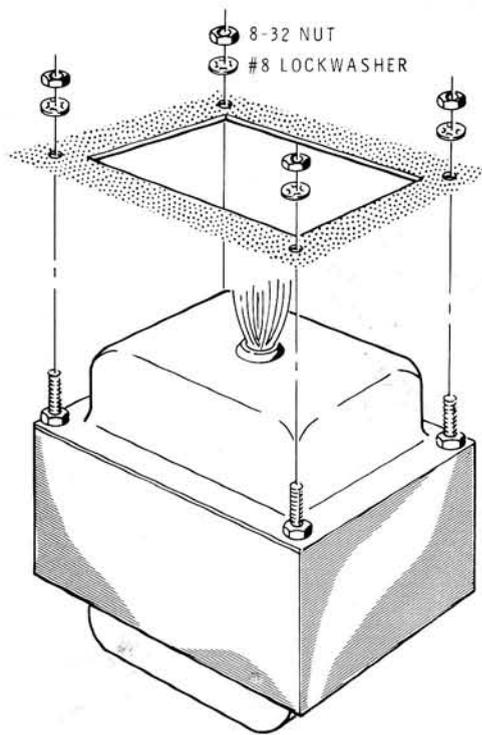

Detail 1G

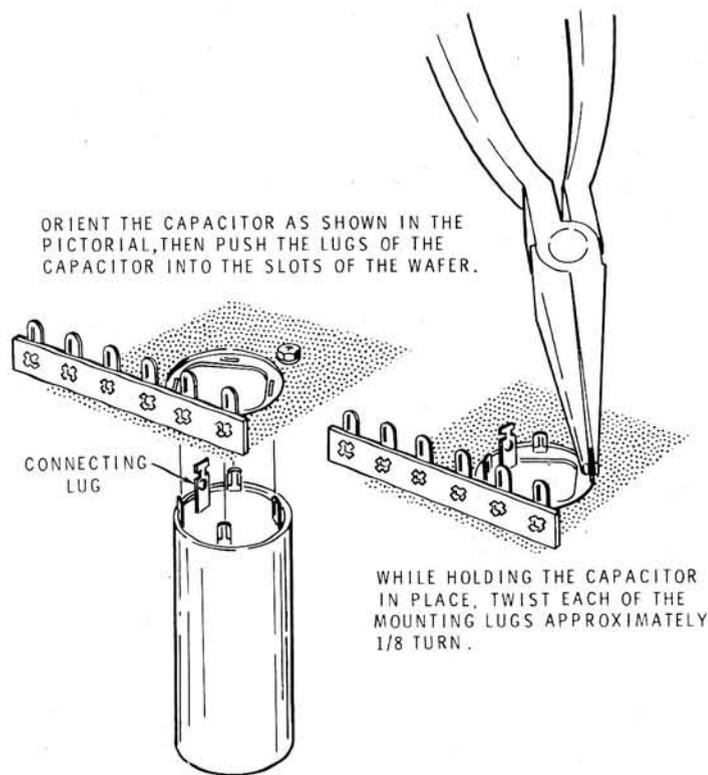

Detail 1H

This completes the Chassis Parts Mounting.

CAUTION: When the chassis is bottom side up, its weight will rest on the transformer and the mounted capacitors. Take care that you do not damage the capacitors during the remainder of the assembly.

TRANSFORMER WIRING

Refer to Pictorial 2 (fold-out from Page 9) for the following steps. Position all wires and leads as shown.

Connect the power transformer leads as follows:

<u>LEAD COLOR</u>	<u>CONNECT TO</u>
() Red	lug 2 of terminal strip J (NS).
() Blue	lug 4 of terminal strip J (NS).
() Red-yellow	lug 1 of capacitor H (NS).
() Green-yellow	lug 6 of socket B (S-1).
() Green	lug 8 of socket B (S-1).
() Yellow	lug 2 of socket B (S-1).
()	Route the brown and yellow-brown leads as shown in the Pictorial. These leads will be connected later.

Alternate Line Voltage Wiring

The power transformer in this Power Supply is equipped with a dual primary winding. It may be operated from either 105-125 VAC or 210-250 VAC, depending on the way in which the primary leads are connected. Two sets of wiring instructions are given. Use only the instructions which apply to the line voltage that you intend to use.

120 VAC Wiring

Refer to Pictorial 2.

- () Connect the black-yellow and black-red transformer leads to lug 9 of socket B (S-2).
- () Connect the black and black-green transformer leads to lug 6 of terminal strip J (NS).

240 VAC Wiring

Refer to Detail 2A.

- () Connect the black-red transformer lead to lug 9 of socket B (S-1).
- () Connect the black transformer lead to lug 6 of terminal strip J (NS).
- () Connect the black-green and black-yellow transformer leads to lug 5 of terminal strip J (S-2).

CHASSIS WIRING

- () Connect the red filter choke lead extending through grommet D to lug 1 of capacitor K (NS).
- () Connect the black filter choke lead extending through grommet D to lug 1 of terminal strip L (NS).
- () Cut a 9" length of the 8-wire cable. Refer to Detail 2B and remove the individual wires from the 9" cable. These wires will be used in the following steps.

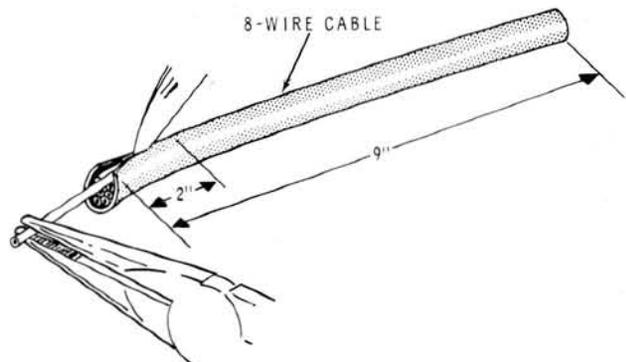

Detail 2B

NOTE: In the following step you will be directed to prepare wires for connection. To prepare a wire, cut it to the stated length and remove 1/4" of insulation from each end. Melt a small amount of solder onto each exposed end to hold the wire strands together.

- () Prepare the following lengths of wire. The wires are listed in the order in which they will be used.

1-1/2" red	8" yellow
5" red	2-1/2" brown
8" orange	9-1/2" green

- () Connect a 1-1/2" red wire from lug 1 of capacitor H (NS) to lug 2 of capacitor F (NS).
- () Connect a 5" red wire from lug 4 of socket B (S-1) to lug 1 of capacitor F (NS).
- () Connect an 8" orange wire from lug 3 of socket B (S-1) to lug 1 of terminal strip L (NS).
- () Connect an 8" yellow wire from lug 1 of socket B (S-1) to lug 3 of terminal strip L (NS).
- () Connect a 2-1/2" brown wire from lug 7 of socket B (S-1) to lug 4 of capacitor H (S-1). Also solder lug 4 to the mounting wafer (S-1).
- () Connect a 9-1/2" green wire from lug 11 of socket B (S-1) to lug 2 of control A (S-1).
- () Connect a 100 k Ω (brown-black-yellow) resistor from lug 1 of capacitor H (S-3) to lug 1 of capacitor F (NS).
- () Connect a 100 k Ω (brown-black-yellow) resistor from lug 5 of capacitor H (S-1) to lug 2 of capacitor F (S-2).
- () Connect a 100 k Ω (brown-black-yellow) resistor between lugs 1 (NS) and 4 (S-1) of capacitor F.
- () Install a 1-1/4" length of black sleeving on one lead of a 100 k Ω (brown-black-yellow) resistor. Then connect this lead to lug 1 of terminal strip L (NS). Connect the other lead to the indicated solder lug at M (NS).
- () Connect a 1000 Ω (brown-black-red) resistor from lug 3 (NS) to lug 4 (NS) of terminal strip L.
- () Connect a 10 k Ω (brown-black-orange) 1 watt resistor from lug 1 of control A (S-1) to lug 2 of terminal strip L (S-1).
- () Connect a 10 k Ω (brown-black-orange) 1 watt resistor from lug 3 of control A (S-1) to lug 3 of terminal strip L (NS).
- () Connect the positive (+) lead of the 40 μ F electrolytic capacitor to lug 1 of terminal strip L (S-4). Connect the other lead to the indicated solder lug at M (S-1). Position this capacitor as shown in the Pictorial.
- () Cut the negative (-) leads of each of the two 20 μ F electrolytic capacitors to a length of 1-1/4". Then install 1" lengths of black sleeving on the negative leads.

COMPONENT INSTALLATION

Refer to Pictorial 3 for the following steps.

NOTE: All resistors used are 2 watt unless specified otherwise in the steps.

- () Connect a 100 k Ω (brown-black-yellow) resistor from lug 2 of capacitor H (S-1) to lug 5 of capacitor F (S-1). Apply enough heat and solder to lug 2 of H to solder it to the mounting wafer.
- () Connect the positive (+) lead of one of the 20 μ F electrolytic capacitors to the indicated solder lug at M (NS). Connect the negative lead to lug 3 of terminal strip L (S-4). Position this capacitor next to the 40 μ F capacitor installed previously.
- () Connect the positive (+) lead of the other 20 μ F electrolytic capacitor to the indicated solder lug at M (S-3). Connect the negative lead to lug 4 of terminal strip L (NS).

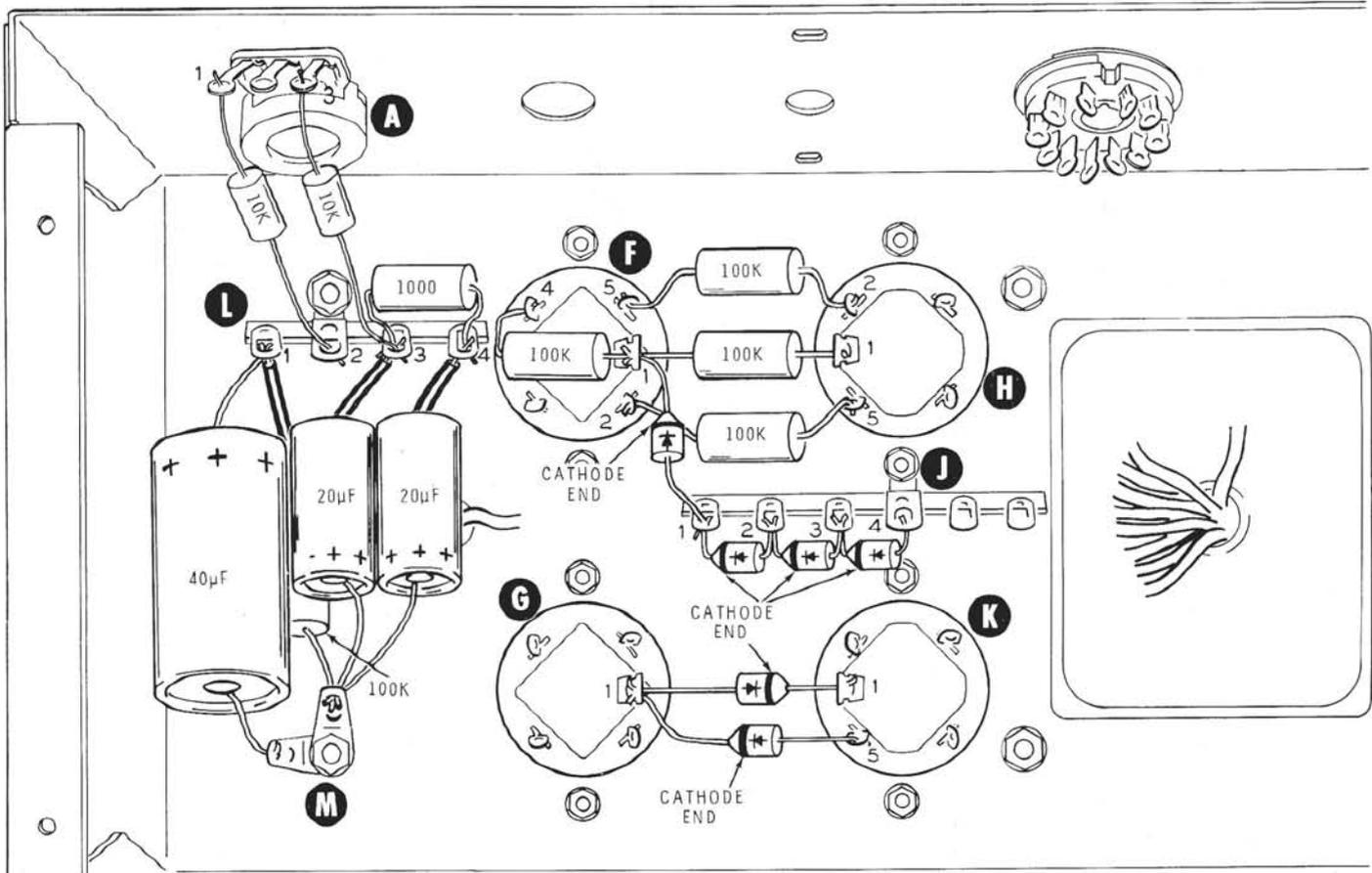

PICTORIAL 3

NOTE: WHEN INSTALLING DIODES, BE SURE TO PLACE THE CATHODE END AS DIRECTED. THE CATHODE END IS MARKED WITH EITHER A COLOR END, COLOR DOT, COLOR BAND, OR A SYMBOL.

COLOR DOT	COLOR BAND	COLOR END	SYMBOL (CATHODE END)

Detail 3A

Refer to Detail 3A to identify the cathode leads of the silicon diodes that will be used in the following steps.

- () Connect the cathode lead of a silicon diode to lug 1 of capacitor F (S-4). Connect the other lead to lug 1 of terminal strip J (NS).
- () Connect the cathode lead of a silicon diode to lug 1 (S-2) and the other lead to lug 2 (NS) of terminal strip J.
- () Connect the cathode lead of a silicon diode to lug 3 (S-2) and the other lead to lug 4 (S-2) of terminal strip J.
- () Connect the cathode lead of a silicon diode to lug 1 of capacitor K (S-2). Connect the other lead to lug 1 of capacitor G (NS).
- () Connect the cathode lead of a silicon diode to lug 1 of capacitor G (S-2). Connect the other lead to lug 5 of capacitor K (S-1). Apply enough heat and solder to lug 5 to solder it to the mounting wafer.

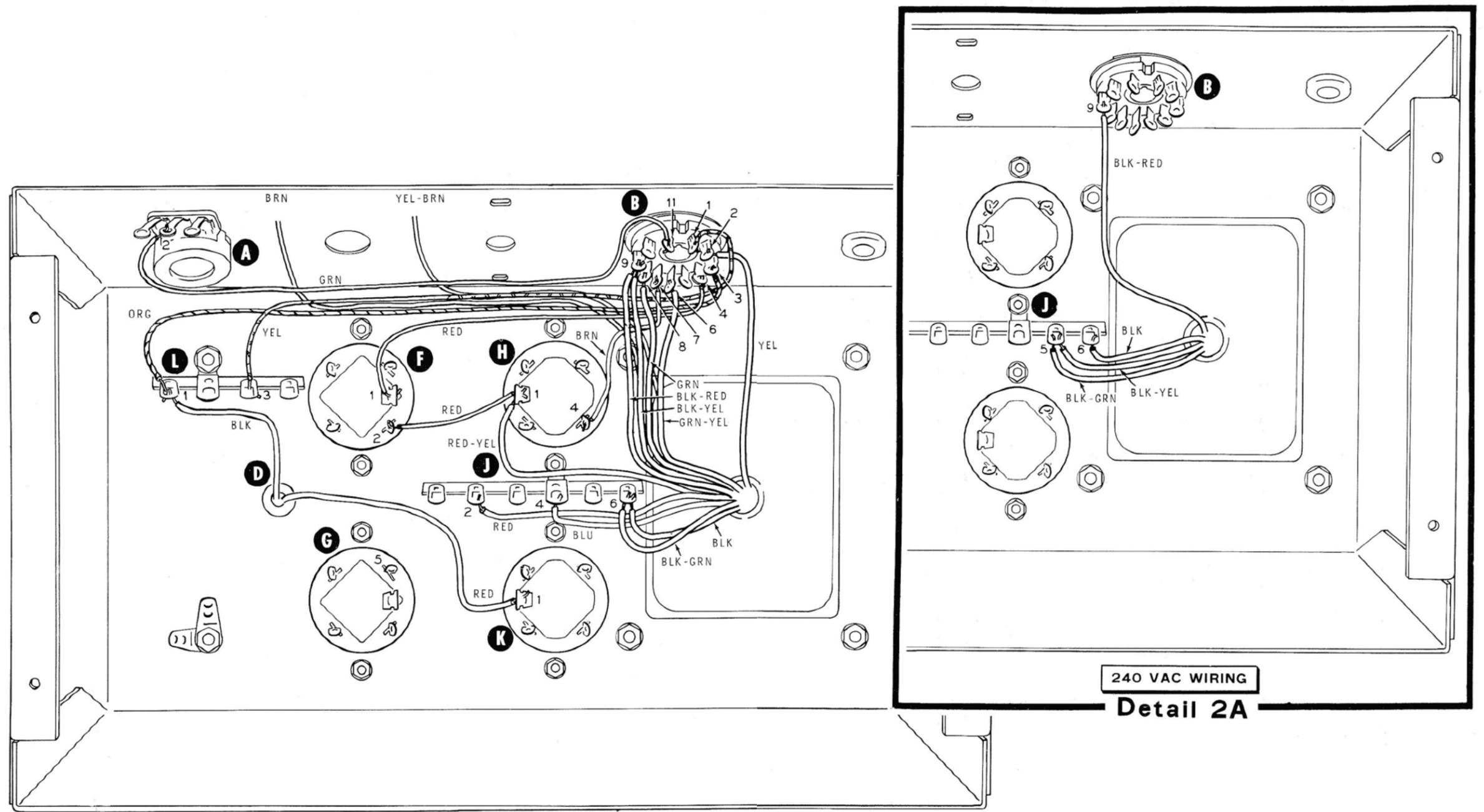

120 VAC WIRING
PICTORIAL 2

240 VAC WIRING
Detail 2A

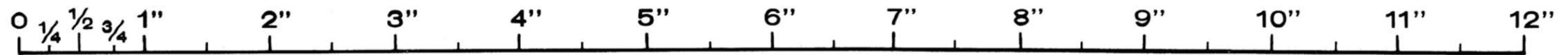

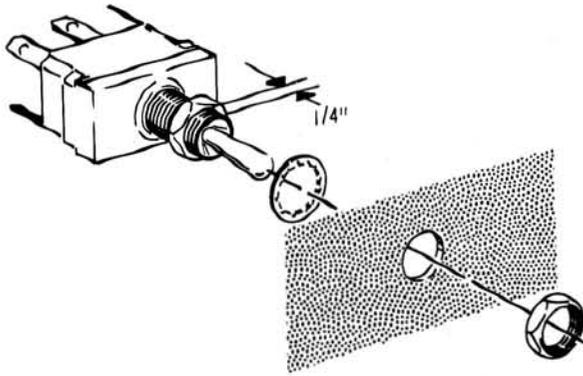

Detail 4A

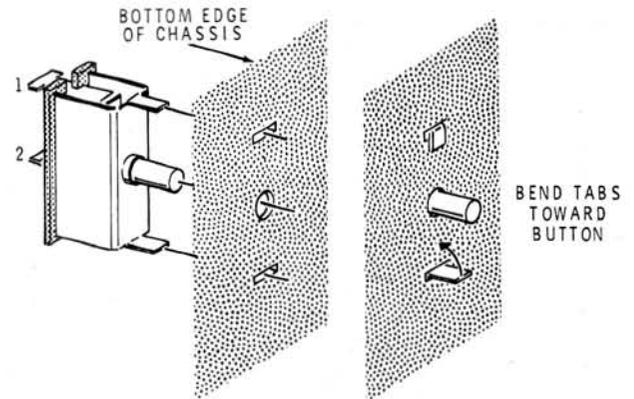

Detail 4B

FINAL WIRING

Refer to Pictorial 4 for the following steps.

- () Install the DPDT toggle switch at N as shown in Detail 4A. Use the hardware supplied with the switch, and position the nut on the bushing as shown.

CAUTION: Before installing the circuit breaker in the following step, make sure the circuit breaker body clears the adjacent wiring of capacitor H by at least 1/8".

- () Refer to Detail 4B and install the circuit breaker at P with the solder lugs oriented as shown. Bend the mounting tabs as shown.
- () Connect the brown lead from the power transformer to lug 1 of switch N (S-1).
- () Connect the yellow-brown lead from the power transformer to lug 3 of switch N (NS).
- () Install a 1" length of black sleeving on each lead of a silicon diode. Connect the cathode lead of this diode to lug 3 of switch N (S-2) and the other lead to lug 4 of terminal strip L (S-3).
- () Prepare the following lengths of wire:
 - 4" blue
 - 5" black
 - 1-1/2" black
 - 1-1/2" black
- () Connect a 4" blue wire from lug 5 of capacitor G (S-1) to lug 2 of switch N (S-1).
- () Connect a 5" black wire from lug 5 of switch N (S-1) to lug 10 of socket B (S-1).
- () Connect a 1-1/2" black wire from lug 4 (S-1) to lug 6 (NS) of switch N.
- () Connect a 1-1/2" black wire from lug 6 of switch N (S-2) to lug 2 of circuit breaker P (S-1).
- () Melt a small amount of solder onto each of the bared ends of the line cord to hold the wire strands together. Then insert the end of the cord through grommet C and tie a knot 6" from the end.



- () Connect one of the line cord wires to lug 1 of circuit breaker P (S-1).
- () Connect the remaining line cord wire to lug 6 of terminal strip J (S-3) [S-2 if wired for 240 V.] Pull any excess line cord back through grommet C, and position the portion that is inside the chassis as shown.

This completes the wiring of the Power Supply.

Carefully examine all connections, looking for unsoldered connections, short circuits, and loose wires or components. Make sure that none of the lugs of socket B are touching each other. Tip and shake the Power Supply to dislodge any wire clippings or bits of solder that may have fallen into the wiring, then proceed to the Final Assembly section that follows.

FINAL ASSEMBLY

Refer to Pictorial 5 for the following steps.

- () Install four rubber feet on the bottom plate. Use 8-32 x 3/8" screws, #8 lockwashers, and 8-32 nuts.
- () Install the blue and white label on the bottom plate at the location shown in Pictorial 5. Carefully peel away the backing paper and press the label into position. Be sure to refer to the numbers on this label in any communications you have with the Heath Company about this kit.

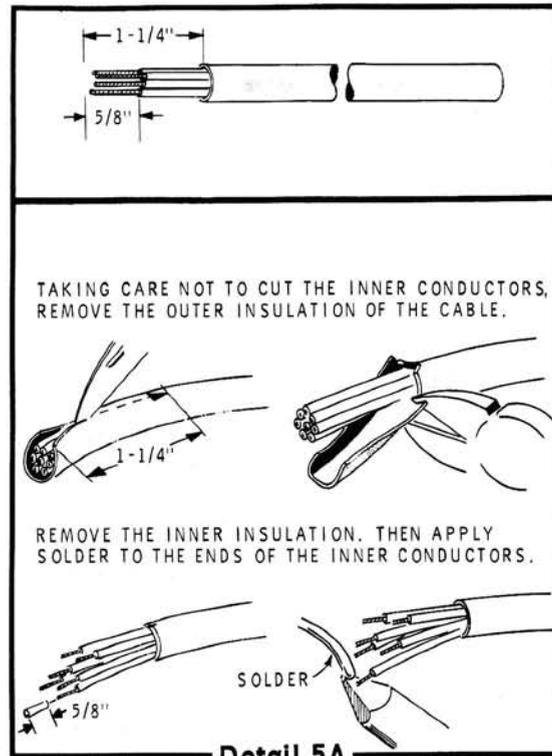

- () Install the bottom plate on the chassis with #6 x 3/8" sheet metal screws.
- () Install the cabinet shell on the chassis. Use #6 x 3/8" sheet metal screws.

Power Cable

- () Refer to Detail 5A and prepare one end of the 8-wire cable.

- () Place the plug cap over the prepared end of the cable and, referring to Detail 5B, connect the cable wires to the 11-pin plug as follows:

WIRE COLOR TO PIN

- | | |
|------------|---|
| () Black | 2 (S-1) |
| () Orange | 3 (S-1) |
| () Yellow | 4 (S-1) |
| () White | 7 (S-1) |
| () Green | 1 (S-1) for -130 V bias, or
11 (S-1) for adjustable bias. |
| () Red | 6 (S-1) for 12 V filaments, or
8 (S-1) for 6 V filaments.* |

*If more than 6 amperes of filament current will be drawn under 6 volt operation, parallel the red cable wire with a length of #18 wire.

- | | |
|-----------|--------------------------|
| () Brown | 9 (S-1) SEE NOTE BELOW. |
| () Blue | 10 (S-1) SEE NOTE BELOW. |

NOTE: If this Power Supply is to be used with equipment that does not have provisions for switching the AC power on and off, install a jumper wire between pins 9 (S-1) and 10 (S-1) of the 11-pin plug. Be sure that the brown and blue cable wires are NOT connected to these pins.

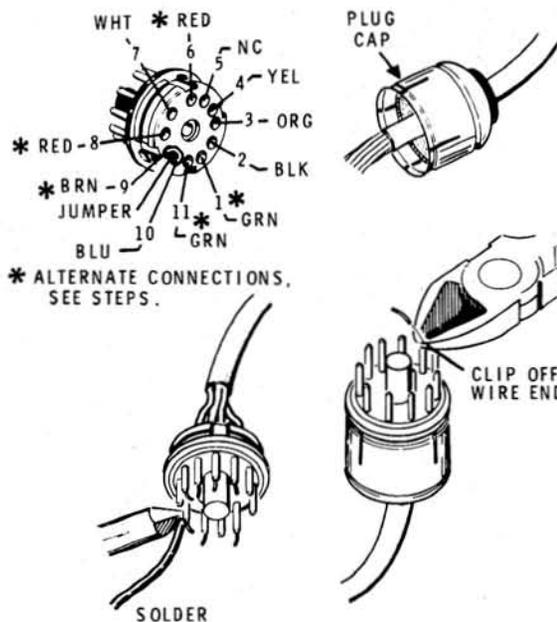

Detail 5B

If this Power Supply is to be used with equipment that does have provisions for switching the AC power on and off, connect the brown and blue cable wires as directed in the steps.

- () Snap the cap onto the power cable plug.

This completes the assembly of your Heathkit AC Power Supply. Proceed to the Initial Tests section.

INITIAL TESTS

To avoid possible damage, it is important that you use an ohmmeter to make the following resistance checks before connecting or turning on the Power Supply. If all measurements are satisfactory, proceed to the Operations section. If any of the measurements do not agree with the values in the table, refer to the In Case Of Difficulty section. DO NOT turn on the Power Supply until the difficulty has been corrected.

- () Set the ohmmeter to the R x 1 scale.

Because some of the circuits to be measured contain diodes, you will obtain different resistance readings if the polarity of the meter leads is reversed in the following measurements.

Therefore, in the first step you will determine the polarity of the ohmmeter test leads and connect the proper lead to chassis ground.

- () Connect the negative lead of the meter to lug 3 and the positive lead to lug 4 of terminal strip J. If the resistance is approximately 10 ohms, connect the negative meter lead to pin 7 (ground) of the power output socket for the following resistance checks. If the meter needle remains on or near the infinity mark (full scale), reverse the meter leads. If you now get a reading of approximately 10 ohms, connect the positive lead of the meter to pin 7 of the power output socket.

() Set your ohmmeter to the R x 10 k resistance scale.

Now use the remaining meter lead to verify the resistance measurements in each of the following steps. Note that the resistance at pin 11 will vary with the setting of the BIAS ADJUST control. When the meter needle continues to move upscale, it indicates that there is a large capacitor in the circuit. Give the needle a few seconds to complete its movement before making the reading.

SOCKET PIN	OHMS
() 1	22 kΩ minimum
() 2	Infinity
() 3	75 kΩ minimum
() 4	75 kΩ minimum

SOCKET PIN	OHMS
() 5	Infinity
() 6	Infinity
() 7	Infinity
() 8	Infinity
() 9	Infinity
() 10	Infinity
() 11	10 kΩ to 20 kΩ

NOTE: DO NOT turn on the Power Supply until the proper connector for your equipment has been installed, as outlined in the following Operations section of this Manual.

OPERATION

CAUTION: The output voltage of this Power Supply can be lethal. Also, the potential stored in the large capacitors is dangerous. Allow time for these capacitors to discharge through the bleeder resistors before working on the Power Supply. The capacitors can be discharged more quickly by shorting the capacitor lugs to the chassis with a screwdriver blade. In a situation where electrical shock is a possibility, stand on some dry insulating material and work with one hand behind your back. Never attempt to do any work on the Power Supply with the line cord connected to an AC outlet.

Connections at the free end of the 8-conductor power supply cable will depend on the requirements of the equipment to be powered. With the cable wired as directed in this Manual, the no-load voltages shown in Table 1 will be available at the free end of the cable. It is recommended that a connector which attaches to the power input socket on your equipment, be permanently installed on the free end of this cable. Connectors

and connection instructions are supplied with Heath products designed for use with this Power Supply.

Cable Wire Color	Voltage
*Green	-130 VDC or -40 to -80 VDC at 1 mA.
Black	Filament common.
Orange	+275 VDC or +350 VDC.
Yellow	+820 VDC.
*Red	6 VAC or 12 VAC.
White	Ground wire.
*Brown	AC switch in equipment.
*Blue	AC switch in equipment.

*The voltage or function available at these cable wires depends upon how the plug at the other end of the cable was wired in the steps on Page 12.

TABLE 1

- () Connect the power cable from the Power Supply to your equipment.
- () Connect the line cord plug to an electrical outlet supplying the voltage for which the Power Supply was wired (120 VAC or 240 VAC).
- () Select the desired low B+ voltage by moving the AC OFF switch to the right for 350 VDC, or to the left for 275 VDC. If your equipment does not have provisions for remote control of the Power Supply, this will turn the Power Supply ON. (Plate and filament voltages are always turned on and off simultaneously.)
- () If your equipment has provisions for remote control of the Power Supply, turn the equipment off-on switch to ON.
- () If you are using the adjustable bias, adjust the bias voltage as necessary with the BIAS ADJUST control.
- () The Power Supply may be turned off by the AC OFF switch on the chassis, or by the off-on switch on your equipment, provided that it was wired for remote control.

IN CASE OF DIFFICULTY

This section of the Manual is divided into two parts. The first part, titled General Troubleshooting Information, describes what to do about any difficulties that may occur right after the Power Supply is assembled.

The second part, a Troubleshooting Chart, is provided to assist in servicing if the General Information does not clear up the problem, or if difficulties occur after the Power Supply has been in operation for some time. This Chart lists some difficulties which could arise, and several possible causes.

GENERAL TROUBLESHOOTING INFORMATION

1. Recheck the wiring. Trace each lead in colored pencil on the Pictorial as it is checked. It is frequently helpful to have a friend check your work. Someone who is not familiar with the unit may notice something consistently overlooked by the builder.
2. About 90% of the kits that are returned to Heath Company for repair do not function properly due to poor connections and soldering. Therefore, many troubles can be eliminated by reheating all connections to make sure that they are soldered as described in the soldering section of the Kit Builders Guide.
3. Check the values of the parts. Be sure that the proper part has been wired into the circuit, as shown in the Pictorial diagrams and as called out in the wiring instructions.
4. Check for bits of solder, wire ends or other foreign matter which may be lodged in the wiring.
5. If, after careful checks the trouble is still not located, check voltage readings against those on the Schematic. NOTE: All voltage readings were taken with an 11 megohm input voltmeter. Voltages shown are with no load on the output.
6. A review of the Circuit Description, and a study of the Schematic Diagram will help you locate a difficulty in the Power Supply.
7. Check for loose hardware. Be especially careful that metal capacitor mounting washers and terminal strip mounting feet are well grounded.
8. Refer to the Kit Builders Guide for Service and Warranty information.

Troubleshooting Chart

DIFFICULTY	POSSIBLE CAUSE
Completely inoperative.	<ol style="list-style-type: none"> 1. Circuit breaker open. 2. Switch defective. 3. Pin 9 or 10 on power output socket or cable plug open or incorrectly wired. 4. Remote switching circuit in associated equipment faulty. 5. Power transformer defective.
Circuit breaker opens when reset.	<ol style="list-style-type: none"> 1. Short in power transformer windings. 2. Short in rectifier or filter circuits. 3. Short in associated equipment. 4. Overload in associated equipment.
No high B+ voltage.	<ol style="list-style-type: none"> 1. Diodes D1, D2, D3 or D4 faulty. 2. Pin 4 on power output socket or power cable plug open or incorrectly wired. 3. Power transformer defective.
No low B+ voltage.	<ol style="list-style-type: none"> 1. Diode D5 and/or D6 open. 2. Filter choke L1 open. 3. Pin 3 of power output socket or cable plug open or incorrectly wired. 4. Switch incorrectly wired or faulty. 5. Polarity of diodes or filter capacitors is incorrect.
No bias voltage.	<ol style="list-style-type: none"> 1. Diode D7 open. 2. Resistors R7, R8 or R9 open. 3. Pin 11 or 1 of power output socket or cable plug open or incorrectly wired.
High B+ voltage only half of indicated value with no load, less under load.	<ol style="list-style-type: none"> 1. Diode D1, D2, D3 or D4 open.
Low B+ voltage only half of indicated value.	<ol style="list-style-type: none"> 1. Diode D5 or D6 open.
All voltages only half of indicated values.	<ol style="list-style-type: none"> 1. Power transformer primary wired for 220 VAC when Power Supply is used on 120 VAC.

SPECIFICATIONS

HIGH VOLTAGE SUPPLY

Output Voltage.	820 volts DC, no load. 700 volts DC at 250 mA.
Effective Output Capacitance.	62.5 μ F.
Ripple.	Less than 1% at 250 mA.
Duty Cycle.	Continuous up to 150 mA. 50% at 300 mA.

LOW VOLTAGE SUPPLY (high tap)

Output Voltage.	350 volts DC, no load. 300 volts DC at 150 mA (with 100 mA load on High Voltage).
Ripple.	Less than .05% at 150 mA.
Duty Cycle.	Continuous up to 175 mA.

LOW VOLTAGE SUPPLY (low tap)

Output Voltage.	275 volts DC, no load. 250 volts DC, at 100 mA (with 100 mA load on High Voltage).
Ripple.	Less than .05% at 150 mA.
Duty Cycle.	Continuous up to 175 mA.

OTHER OUTPUT VOLTAGES

Fixed Bias.	-130 volts DC, no load. -100 volts DC, at 20 mA.
Adjustable Bias.	-80 to -40 volts DC, at 1 mA maximum.
Filaments.	6.3 volts AC at 11 amperes. 12.6 volts AC at 5.5 amperes.

GENERAL

Power Requirements.	120/240 volts AC, 50/60 Hz, 350 watts maximum.
Dimensions.	9" long x 4-3/4" wide x 6-3/4" high.
Net Weight.	16 lbs.

The Heath Company reserves the right to discontinue instruments and to change specifications at any time without incurring any obligation to incorporate new features in instruments previously sold.

CIRCUIT DESCRIPTION

To better understand the circuit operation, refer to the Schematic Diagram while reading the following description. Each section of the Power Supply will be discussed individually.

PRIMARY CIRCUIT

The AC OFF switch, circuit breaker, transformer primary, and two terminals of the power output socket are wired in series across the AC line. The Power Supply may be controlled by its AC OFF switch, or by the off-on switch in the equipment being used with it. The dual primary winding may be connected in series for 240 VAC line operation, or in parallel for use on a 120 VAC line.

HIGH VOLTAGE SECONDARY CIRCUIT

The high voltage winding applies approximately 282 volts AC (RMS) to a full-wave voltage doubler rectifying circuit consisting of silicon diodes D1, D2, D3 and D4, and capacitors C1 and C2. These diodes are connected so that during one-half cycle, capacitor C2 becomes charged; and during the next half cycle capacitor C1 is charged. Resistors R1, R2, R3, and R4 are connected in the circuit to provide a discharge path for capacitors C1 and C2. The capacitors are charged individually, but discharge in series to produce a DC voltage equal to approximately twice the applied peak AC voltage. Excellent dynamic regulation is provided by the large capacitance values of C1 and C2. The output of the voltage doubler circuit has a low ripple content and no further filtering is required.

LOW VOLTAGE CIRCUIT

The low voltage winding is tapped so that either 95 or 125 volts AC (RMS) may be applied to a half-wave voltage-doubler rectifying circuit consisting of diodes D5 and D6, and capacitors C3 and C4. Capacitor C4 is also used with choke L1 and capacitor C5 in a pi filter, C4 being the input capacitor in the filter network. The use of a high-capacitance input pi filter network provides a well filtered DC output that has a very low percentage of ripple.

BIAS VOLTAGE CIRCUIT

The bias voltage is obtained from the low tap on the low voltage winding. About 95 volts AC (RMS) is applied to half-wave rectifier diode D7. Capacitors C6 and C7, with resistor R7, provide a filter network to remove the ripple from the bias voltage. Either -130 volts of fixed bias or from -40 to -80 volts of adjustable bias may be used by connecting to the appropriate pin of the power output socket. The adjustable bias is set by the Bias Adjust control R9. Resistors R8 and R10 are used to limit the range of the Bias Adjust control.

FILAMENT VOLTAGE CIRCUIT

The 12.6 volt filament winding is center tapped so that either 6.3 or 12.6 volts AC can be obtained.

CHASSIS PHOTOGRAPH

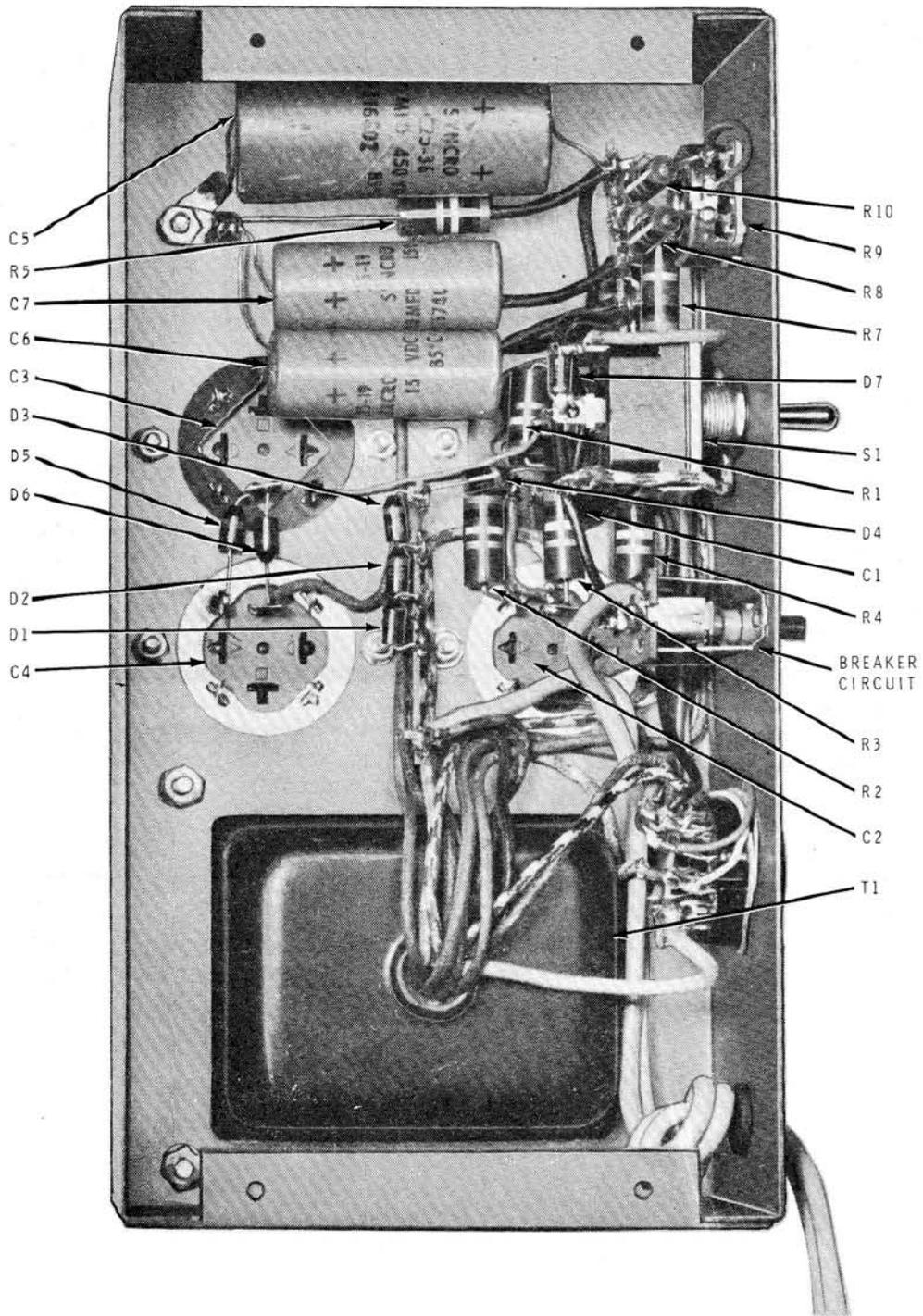

REPLACEMENT PARTS PRICE LIST

The following prices apply only on purchases from the Heath Company where shipment is to a U.S.A. destination. Selling prices elsewhere in U.S.A. may be slightly higher to offset transportation and local taxes. Outside the U.S.A. parts and service are available from your local Heathkit source and will reflect additional transportation, taxes, duties and rates of exchange.

PART No.	PRICE Each	DESCRIPTION
RESISTORS		
1-9-1	.10	10 kΩ 1 watt
1-15-2	.15	1 kΩ 2 watt
1-24-2	.15	100 kΩ 2 watt
CAPACITORS		
25-19	.55	20 μF electrolytic
25-36	1.05	40 μF electrolytic
25-34	2.25	125 μF tab-mount electrolytic
HARDWARE		
#6 Hardware		
250-8	.05	#6 x 3/8" sheet metal screw
250-89	.05	6-32 x 3/8" screw
252-3	.05	6-32 nut
254-1	.05	#6 lockwasher

PART No.	PRICE Each	DESCRIPTION
#8 Hardware		
250-137	.05	8-32 x 3/8" screw
252-4	.05	8-32 nut
254-2	.05	#8 lockwasher
259-2	.05	#8 solder lug

MISCELLANEOUS

10-57	.35	10 kΩ tab-mount control
57-27	.50	Silicon diode
431-40	.10	4-lug terminal strip
431-55	.10	6-lug terminal strip
481-1	.10	Metal capacitor mounting wafer
481-3	.10	Phenolic capacitor mounting wafer
438-29	.45	11-pin plug
440-1	.20	Plug cap
434-118	.40	11-pin socket
435-1	.10	Socket mounting ring
61-12	1.70	DPDT toggle switch
65-17	.65	Circuit breaker
73-1	.10	3/8" grommet
73-4	.10	5/16" grommet
54-198	12.40	Power transformer
46-22	5.00	Filter choke
200-505	1.60	Chassis
205-168-1	.65	Bottom plate
100-538-1	1.35	Cabinet shell
261-6	.10	Rubber foot
347-18	.15/ft	8-wire cable
346-1	.05/ft	Black sleeving
89-19	.55	Line cord
490-5	.10	Nut starter
331-6	.10	Solder
595-924	2.00	Manual

HEATH COMPANY

BENTON HARBOR, MICHIGAN

THE WORLD'S FINEST ELECTRONIC EQUIPMENT IN KIT FORM