

Signal Line    Control Line    Voltage Line ( ) TX Voltage

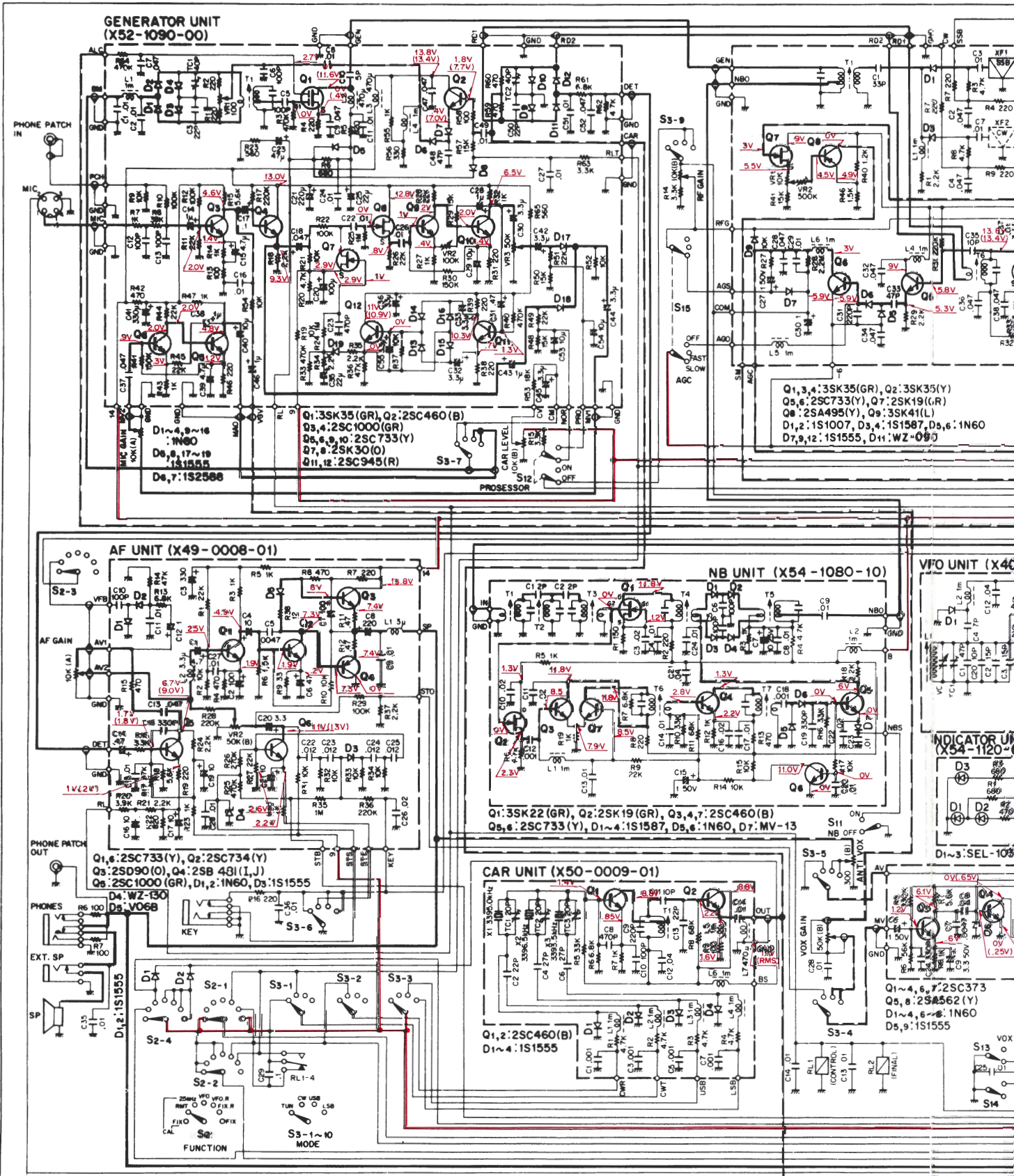

# SCHEMATIC DIAGRAM

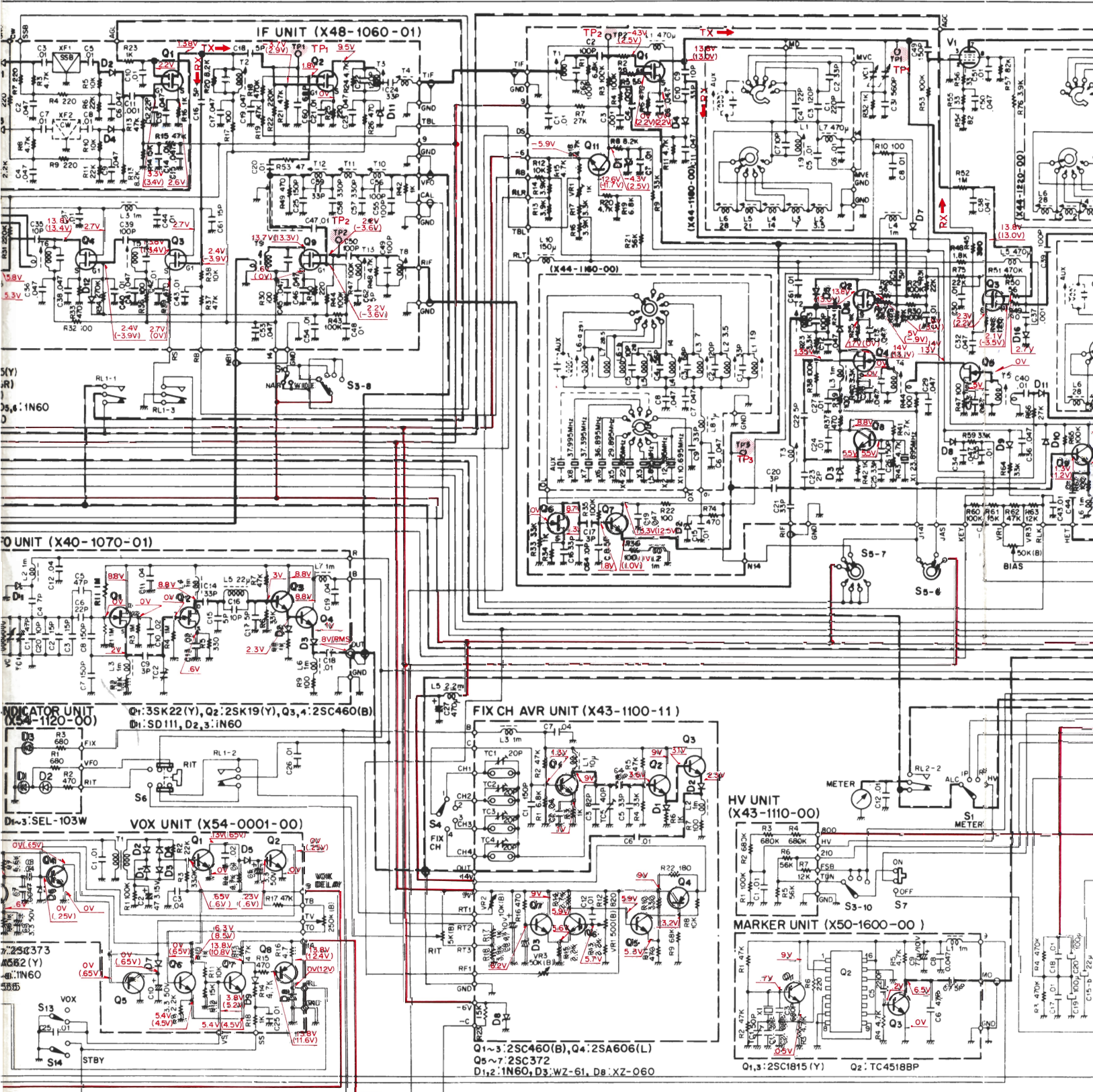

ALC 6  
RELEY 5  
GRD 1

RF UNIT (X44-1200-00)

- O1,2: 3SK41(L) or 3SK40(L)
- O3: 3SK35(GR)
- O4: 3SK22(GR)
- O5,6: 2SK19(GR)
- O7~9: 2SC460(B)
- O10: 2SC1515(K)
- O11: 2SC733(Y)
- D1~3,13: WZ090
- D4,11,12: 1S2588
- D5,6,16: 1S1587
- D7,10,17: 1S1555
- D8,9,14,15: V06B
- V1: 12BY7A

9.1V Zener

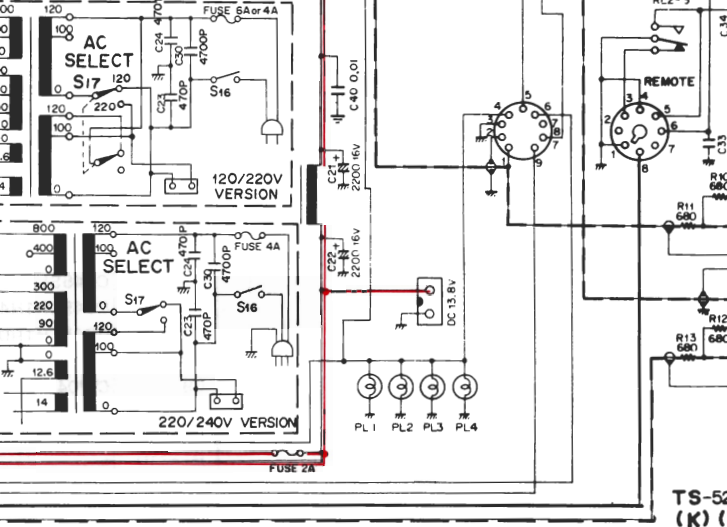
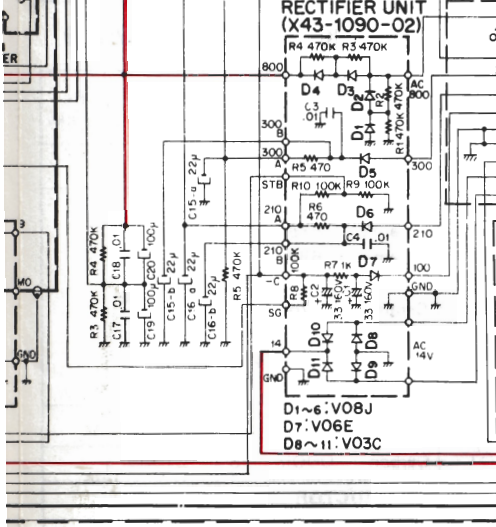
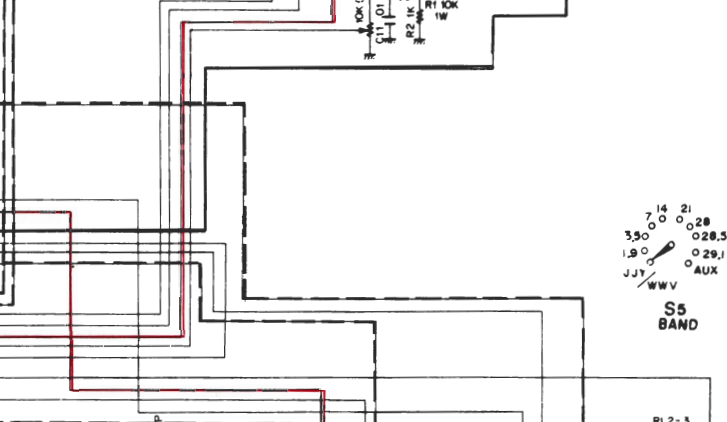
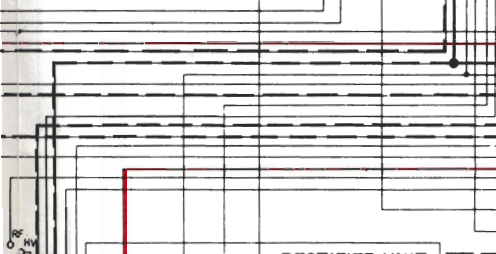
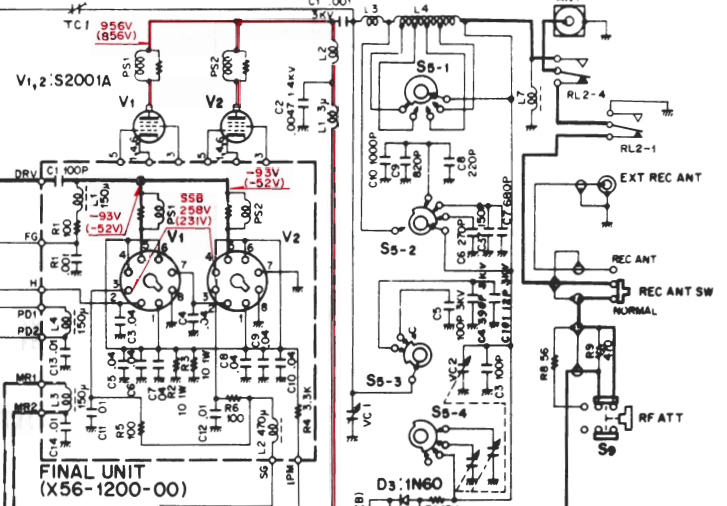
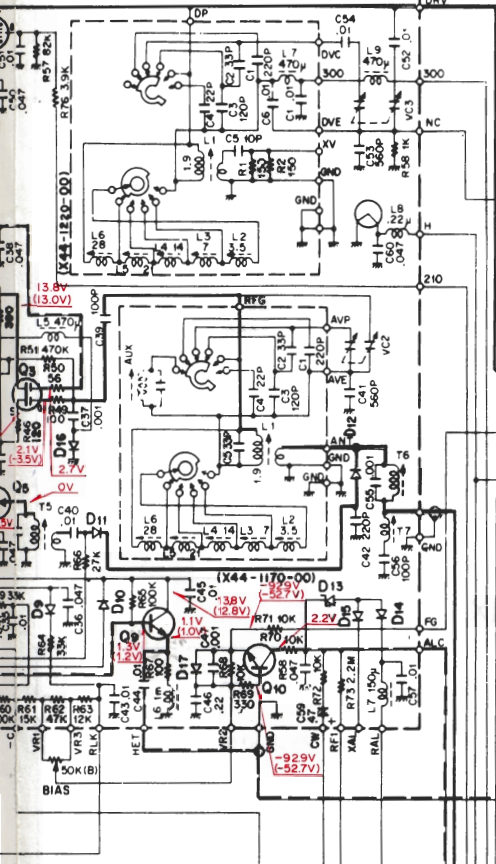

TS-520SE (K) (W)