

PRICE \$2.00

HEATHKIT® ASSEMBLY MANUAL

HEATH COMPANY • BENTON HARBOR, MICHIGAN

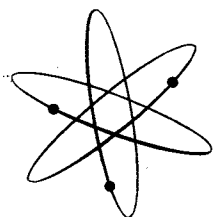









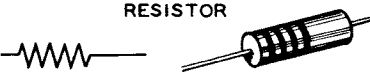
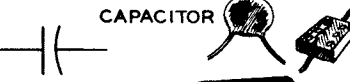
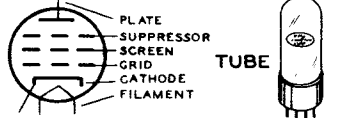
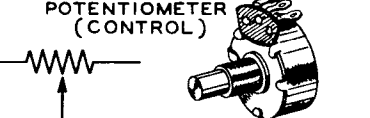
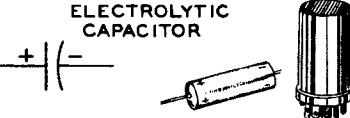

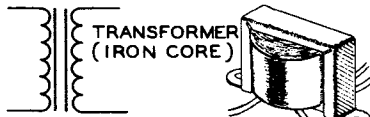

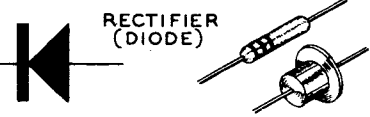
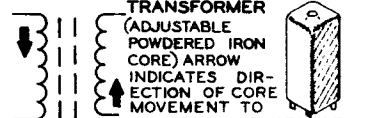
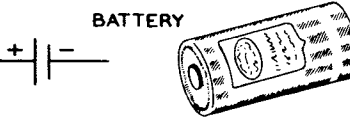
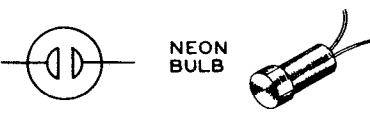
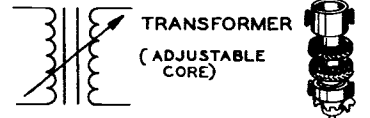

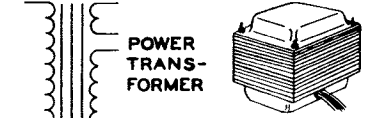

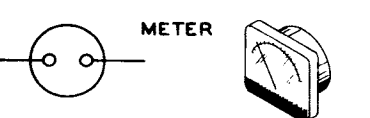
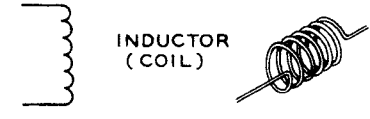

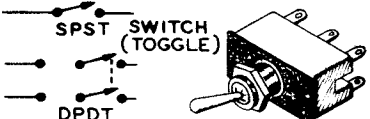
AC POWER SUPPLY
MODEL HP-23

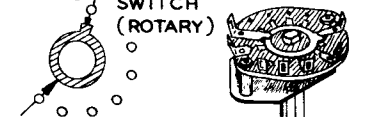
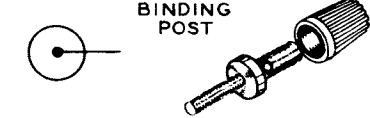
TYPICAL COMPONENT TYPES

This chart is a guide to commonly used types of electronic components. The symbols and related illustrations

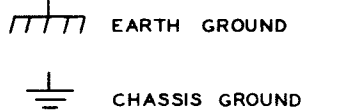
should prove helpful in identifying most parts and reading the schematic diagrams.

| | | |
|--|---|--|
| <p style="text-align: center;">RESISTOR</p>  | <p style="text-align: center;">CAPACITOR</p>  | <p style="text-align: center;">TUBE</p>  |
| <p style="text-align: center;">POTENTIOMETER (CONTROL)</p>  | <p style="text-align: center;">ELECTROLYTIC CAPACITOR</p>  | <p style="text-align: center;">TRANSISTOR</p>  |
| <p style="text-align: center;">TRANSFORMER (IRON CORE)</p>  | <p style="text-align: center;">VARIABLE CAPACITOR</p>  | <p style="text-align: center;">RECTIFIER (DIODE)</p>  |
| <p style="text-align: center;">TRANSFORMER (ADJUSTABLE POWDERED IRON CORE) ARROW INDICATES DIRECTION OF CORE MOVEMENT TO INCREASE INDUCTANCE</p>  | <p style="text-align: center;">BATTERY</p>  | <p style="text-align: center;">NEON BULB</p>  |
| <p style="text-align: center;">TRANSFORMER (ADJUSTABLE CORE)</p>  | <p style="text-align: center;">PHONO JACK</p>  | <p style="text-align: center;">ILLUMINATING BULB</p>  |
| <p style="text-align: center;">POWER TRANSFORMER</p>  | <p style="text-align: center;">PHONE JACK</p>  | <p style="text-align: center;">METER</p>  |
| <p style="text-align: center;">INDUCTOR (COIL)</p>  | <p style="text-align: center;">RECEPTACLE</p>  | <p style="text-align: center;">SWITCH (TOGGLE)</p>  |
| <p style="text-align: center;">PIEZOELECTRIC CRYSTAL</p>  | <p style="text-align: center;">SPEAKER</p>  | <p style="text-align: center;">SWITCH (ROTARY)</p>  |
| <p style="text-align: center;">BINDING POST</p>  | <p style="text-align: center;">MICROPHONE</p>  | <p style="text-align: center;">FUSE</p>  |
| <p style="text-align: center;">ANTENNA</p>  | <p style="text-align: center;">EARTH GROUND</p> <p style="text-align: center;">CHASSIS GROUND</p>  | <p style="text-align: center;">CONDUCTORS</p>  |

Assembly
and
Operation
of the



AC POWER SUPPLY
MODEL HP-23

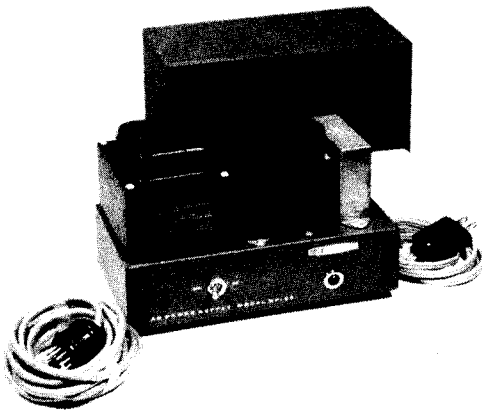

HEATH COMPANY
BENTON HARBOR,
MICHIGAN

TABLE OF CONTENTS

| | |
|--|----|
| Specifications | 2 |
| Introduction | 3 |
| Circuit Description | 3 |
| Construction Notes | 4 |
| Parts List | 5 |
| Proper Soldering Techniques | 6 |
| Schematic | 7* |
| Step-By-Step Procedure | 8 |
| Step-By-Step Assembly | 8 |
| Operation | 15 |
| In Case Of Difficulty | 15 |
| Service Information | 16 |
| Service | 16 |
| Replacements | 17 |
| Shipping Instructions | 17 |
| Warranty | 18 |
| Replacement Parts Price List | 18 |

*Fold-out from page.



SPECIFICATIONS

| | |
|---------------------------------------|--|
| High Voltage. | 820 volts DC, no load. 700 volts DC, at 250 ma. |
| Effective Output Capacitance. | 62,5 μ fd. |
| Ripple. | Less than 1% at 250 ma. |
| Duty Cycle. | Continuous up to 150 ma, to 300 ma at 50%. |
| Low Voltage (High Tap). | 350 volts DC, no load. 300 volts DC, at 150 ma (with 100 ma load on High Voltage). |
| Ripple. | Less than .05% at 150 ma. |
| Duty Cycle. | Continuous up to 175 ma. |
| Low Voltage (Low Tap). | 275 volts DC, no load. 250 volts DC, at 100 ma (with 100 ma load on High Voltage). |
| Ripple. | Less than .05% at 150 ma. |
| Duty Cycle. | Continuous up to 175 ma. |
| Fixed Bias. | -130 volts DC, no load. -100 volts DC, at 20 ma. |
| Ripple. | Less than .5% at 20 ma. |
| Duty Cycle. | Continuous up to 20 ma. |
| Adjustable Bias. | -80 to -40 volts DC, at 1 ma maximum. |
| Filaments. | 6,3 volts AC at 11 amperes, 12,6 volts AC at 5,5 amperes. |
| Power Requirements. | 120 volts AC, 50/60 cps, 350 watts maximum. |
| Dimensions. | 9" long x 4-3/4" wide x 6-3/4" high. |
| Net Weight. | 16 lbs. |

The Heath Company reserves the right to dis-
continue instruments and to change specifica-
tions at any time without incurring any obliga-

tion to incorporate new features in instruments
previously sold.

INTRODUCTION

The Heathkit Model HP-23 AC Power Supply is designed to provide operating voltages for Heathkit mobile amateur radio equipment in fixed-station or portable use. The versatility and many features of this Power Supply also make it ideal for use with many other types of amateur radio equipment.

The Power Supply features a high voltage source, a choice of two low voltage sources, fixed 130 volts bias or adjustable bias, extensive filtering, and good regulation. The power transformer

uses a center-tapped filament winding for 6 or 12 volt filament operation.

A series OFF-ON switch is provided in the fused primary circuit of the Power Supply to permit turning the Power Supply off or on remotely from the equipment with which it is used. All voltage connections to the Power Supply are made through an 11-pin plug. This plug provides an easy means of rapidly changing the equipment from mobile to fixed station operation.

CIRCUIT DESCRIPTION

To better understand circuit operation, refer to the Schematic Diagram while reading the following description. The power transformer has four separate windings, each representing a separate section of the power supply. Each section will be discussed individually.

PRIMARY WINDING

AC Line voltage is applied through the fused line cord plug to the primary winding of power transformer T1. An OFF-ON switch is provided in series with one primary lead of T1. This switch is wired in series with two terminals of the power output socket. This makes it possible to control the Power Supply with the off-on switch in the equipment being used with the Power Supply.

HIGH VOLTAGE SECONDARY WINDING

The high voltage winding, the red and red-yellow leads, apply approximately 268 volts AC (rms) to a full-wave voltage-doubler circuit, consisting of silicon diodes D1, D2, D3, and D4, and capacitors C1 and C2. These diodes are connected so that during one-half cycle, capacitor C2 becomes charged; and during the next half cycle, capacitor C1 is charged. Resistors R1, R2, R3, and R4 are connected in the circuit to provide a discharge path for capacitors C1 and C2. The capacitors are charged individually, but discharge in series to produce a DC voltage equal to approximately twice the applied peak AC voltage. Because of the large capacitance

values of C1 and C2, the output of the voltage-doubler circuit has a low ripple content and no further filtering is required. The large capacitance of C1 and C2 also provides excellent dynamic regulation.

LOW VOLTAGE WINDING

The low voltage winding, brown, brown-yellow, and blue leads, is tapped to make it possible to apply either 125 or 95 volts AC (rms) to a half-wave voltage-doubler circuit, consisting of diodes D5 and D6, and capacitors C3 and C4. Capacitors C3 and C4 are also used with choke L1 and capacitor C5 in a pi filter; C3 and C4 represent the input capacitance of the filter. The use of a high-capacitance input pi filter network provides a well filtered DC output that has a very low percentage of ripple.

BIAS VOLTAGE

The bias voltage is obtained from the tap on the low voltage winding. About 95 volts AC (rms) from the brown-yellow lead is applied to half-wave rectifier diode D7. Capacitors C6 and C7 along with resistor R7 provide a filter network to remove the 60 cps ripple from the bias voltage. Either -130 volts of fixed bias is available, or the Power Supply plug may be wired so that an adjustable bias of from -40 to -80 volts is present. The bias can then be adjusted by ADJUST BIAS

control R9. Resistors R8 and R10 are used to limit the range of the ADJUST BIAS control so that when the Power Supply is used with a transmitter, excessive power amplifier current will not be drawn if the control is turned too near to its minimum resistance.

FILAMENT VOLTAGE WINDING

The filament winding, green, green-yellow, and yellow leads, is center tapped so that either 6 or 12 volts can be obtained.

CONSTRUCTION NOTES

This manual is supplied to assist you in every way to complete your kit with the least possible chance for error. The arrangement shown is the result of extensive experimentation and trial. If followed carefully, the result will be highly stable and dependable performance. We suggest that you retain the manual in your files for future reference, both in the use of the equipment and for its maintenance.

UNPACK THE KIT CAREFULLY AND CHECK EACH PART AGAINST THE PARTS LIST. In so doing, you will become acquainted with the parts. Refer to the information on the inside covers of the manual to help you identify the components. If some shortage or parts damage is found in checking the Parts List, please read the Replacements section and supply the information called for therein.

Resistors generally have a tolerance rating of 10% unless otherwise stated in the Parts List. Tolerances on capacitors are generally even greater. Limits of +100% and -20% are common for electrolytic capacitors.

We suggest that you do the following before work is started:

1. Lay out all parts so that they are readily available.
2. Provide yourself with good quality tools. Basic tool requirements consist of a screwdriver with a 1/4" blade; a small screwdriver with a 1/8" blade; long-nose pliers; wire cutters, preferably separate diagonal cutters; a penknife or a tool for stripping insulation from wires; a soldering iron (or gun) and rosin core solder. A set of nut drivers and a nut starter, while not necessary, will aid extensively in construction of the kit.

Most kit builders find it helpful to separate the various parts into convenient categories. Muffin tins or molded egg cartons make convenient trays for small parts. Resistors and capacitors may be placed with their lead ends inserted in the edge of a piece of corrugated cardboard until they are needed. Values can be written on the cardboard next to each component. The illustration shows one method that may be used.

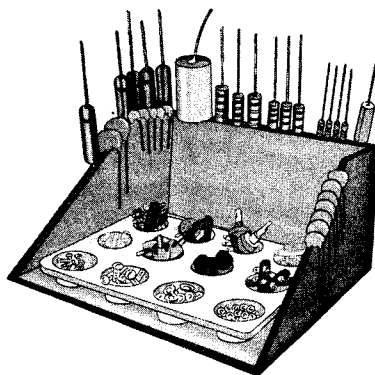

PARTS LIST

PARTS PICTORIAL

NOTE: The numbers in parentheses in the Parts List are keyed to the numbers on the Parts Pictorial to aid in parts identification.

| PART No. | PARTS Per Kit | DESCRIPTION |
|----------|---------------|-------------|
|----------|---------------|-------------|

RESISTORS-CAPACITORS

| | | |
|------------|---|--|
| (1) 1-9-1 | 2 | 10 K Ω 1 watt resistor (brown-black-orange) |
| (2) 1-15-2 | 1 | 1000 Ω 2 watt resistor (brown-black-red) |
| 1-24-2 | 6 | 100 K Ω 2 watt resistor (brown-black-yellow) |
| (3) 25-19 | 2 | 20 μ fd 150 V electrolytic capacitor |
| 25-36 | 1 | 40 μ fd 450 V electrolytic capacitor |
| (4) 25-34 | 4 | 125 μ fd 450 V electrolytic capacitor |

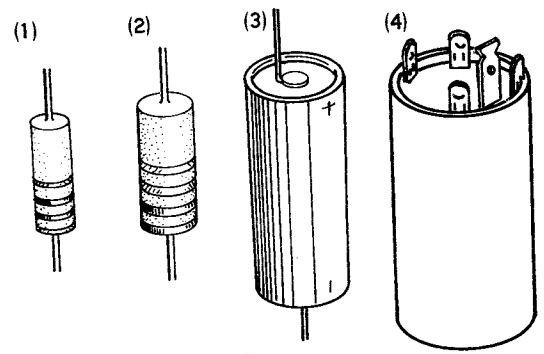

CONTROL-SWITCH-GROMMETS-CHOKE

| | | |
|-----------|---|---------------------------------|
| (5) 10-57 | 1 | 10 K Ω twist-tab control |
| 46-22 | 1 | Filter choke |
| (6) 61-1 | 1 | SPST toggle switch |
| 73-1 | 1 | 3/8" rubber grommet |
| 73-4 | 1 | 5/16" rubber grommet |

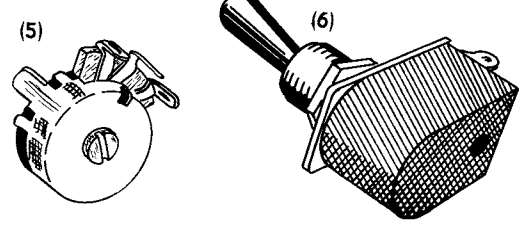

HARDWARE

| | | |
|-------------|----|----------------------|
| (7) 250-137 | 6 | 8-32 x 3/8" screw |
| (8) 250-89 | 9 | 6-32 x 3/8" screw |
| (9) 250-8 | 8 | #6 sheet metal screw |
| (10) 252-4 | 10 | 8-32 nut |
| (11) 252-3 | 9 | 6-32 nut |
| (12) 254-2 | 10 | #8 lockwasher |
| (13) 254-1 | 9 | #6 lockwasher |
| (14) 259-1 | 1 | #6 solder lug |
| (15) 259-2 | 1 | #8 solder lug |

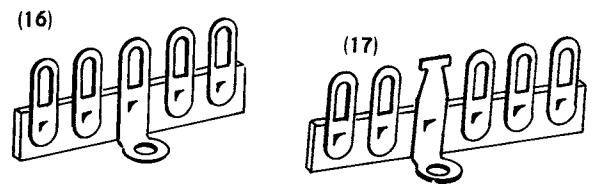
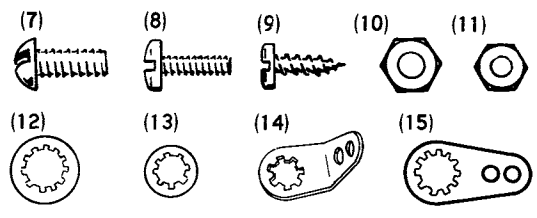

TERMINAL STRIPS-SOCKET-PLUG

| | | |
|--------------|---|----------------------|
| (16) 431-11 | 1 | 5-lug terminal strip |
| (17) 431-55 | 1 | 6-lug terminal strip |
| (18) 434-118 | 1 | Power socket |
| (19) 438-11 | 1 | Fused plug |
| (20) 438-29 | 1 | Power plug |

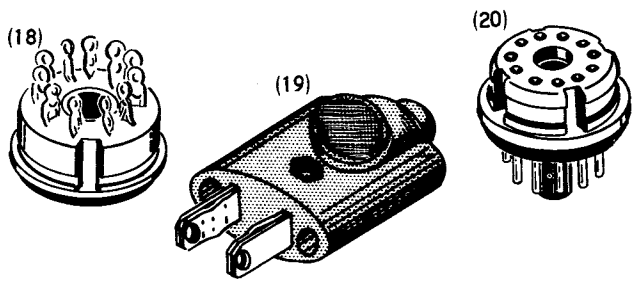

| <u>PART No.</u> | <u>PARTS Per Kit</u> | <u>DESCRIPTION</u> |
|----------------------|----------------------|-------------------------------------|
| MISCELLANEOUS | | |
| 54-143 | 1 | Power transformer |
| (1) 57-27 | 7 | 500 ma, 500 volt PIV silicon diode |
| 89-4 | 1 | Line cord |
| 100-538-1 | 1 | Top cover |
| 200-384-1 | 1 | Chassis |
| 205-168-1 | 1 | Bottom plate |
| 261-6 | 4 | Rubber foot |
| 347-18 | 1 | 8-conductor cable |
| 412-10 | 1 | Pilot lamp |
| 421-5 | 2 | 4-ampere fuse |
| 435-1 | 1 | Power socket mounting ring |
| 440-1 | 1 | Power plug cap |
| (2) 481-1 | 2 | Metal capacitor mounting wafer |
| 481-3 | 2 | Insulated capacitor mounting wafer |
| 331-6 | | Solder |
| 391-34 | 1 | Blue and white identification label |
| 597-260 | 1 | Parts Order Form |
| 595-635 | 1 | Manual |

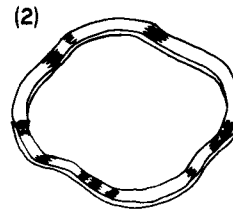

PROPER SOLDERING TECHNIQUES

Only a small percentage of customers find it necessary to return equipment for factory service. By far the largest portion of malfunctions in this equipment are due to poor or improper soldering.

If terminals are bright and clean and free of wax, frayed insulation and other foreign substances, no difficulty will be experienced in soldering. Correctly soldered connections are essential if the performance engineered into a kit is to be fully realized. If you are a beginner with no experience in soldering, a half hour's practice with some odd lengths of wire may be a worthwhile investment.

For most wiring, a 25 to 100 watt iron or its equivalent in a soldering gun is very satisfactory. A lower wattage iron than this may not heat the connection enough to flow the solder smoothly. Keep the iron tip clean by wiping it from time to time with a cloth.

CHASSIS WIRING AND SOLDERING

1. Unless otherwise indicated, all wire used is the type with colored insulation (hookup wire). In preparing a length of hookup wire, 1/4" of insulation should be removed from each end unless directed otherwise in the assembly step.

2. To avoid breaking internal connections when stripping insulation from the leads of transformers or similar components, care should be taken not to pull directly on the lead. Instead, hold the lead with pliers while it is being stripped.
3. Leads on resistors, capacitors, and similar components are generally much longer than need be to make the required connections. In these cases, the leads should be cut to proper length before the part is installed. In general, the leads should be just long enough to reach their terminating points.

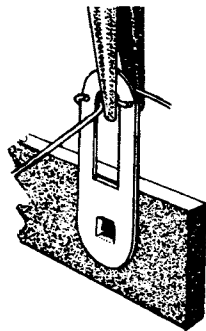

4. Crimp or bend the lead (or leads) around the terminal to form a good joint without relying on solder for physical strength. If the lead is too large to allow bending or if the step states that it is not to be crimped, position it so that a good solder connection can still be made.

5. Position the work, if possible, so that gravity will help to keep the solder where you want it.

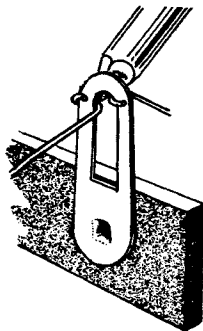

6. Place a flat side of the soldering iron tip against the joint to be soldered until it is heated sufficiently to melt the solder.

7. Then place the solder against the connection and it will immediately flow over the joint; use only enough solder to thoroughly wet the junction. It is usually not necessary to fill the entire hole in the terminal with solder.

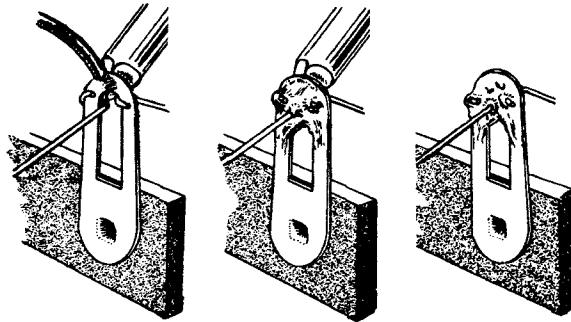

8. Remove the solder and then the iron from the completed joint. Use care not to move the leads until the solder is solidified.

A poor or cold solder joint will usually look crystalline and have a grainy texture, or the solder will stand up in a blob and will not have adhered to the joint. Such joints should be reheated until the solder flows smoothly. In some cases, it may be necessary to add a little more solder to achieve a smooth, bright appearance.

ROSIN CORE SOLDER HAS BEEN SUPPLIED WITH THIS KIT. THIS TYPE OF SOLDER MUST BE USED FOR ALL SOLDERING IN THIS KIT. ALL GUARANTEES ARE VOIDED AND WE WILL NOT REPAIR OR SERVICE EQUIPMENT IN WHICH ACID CORE SOLDER OR PASTE FLUXES HAVE BEEN USED. IF ADDITIONAL SOLDER IS NEEDED, BE SURE TO PURCHASE ROSIN CORE (60:40 or 50:50 TIN-LEAD CONTENT) RADIO TYPE SOLDER.

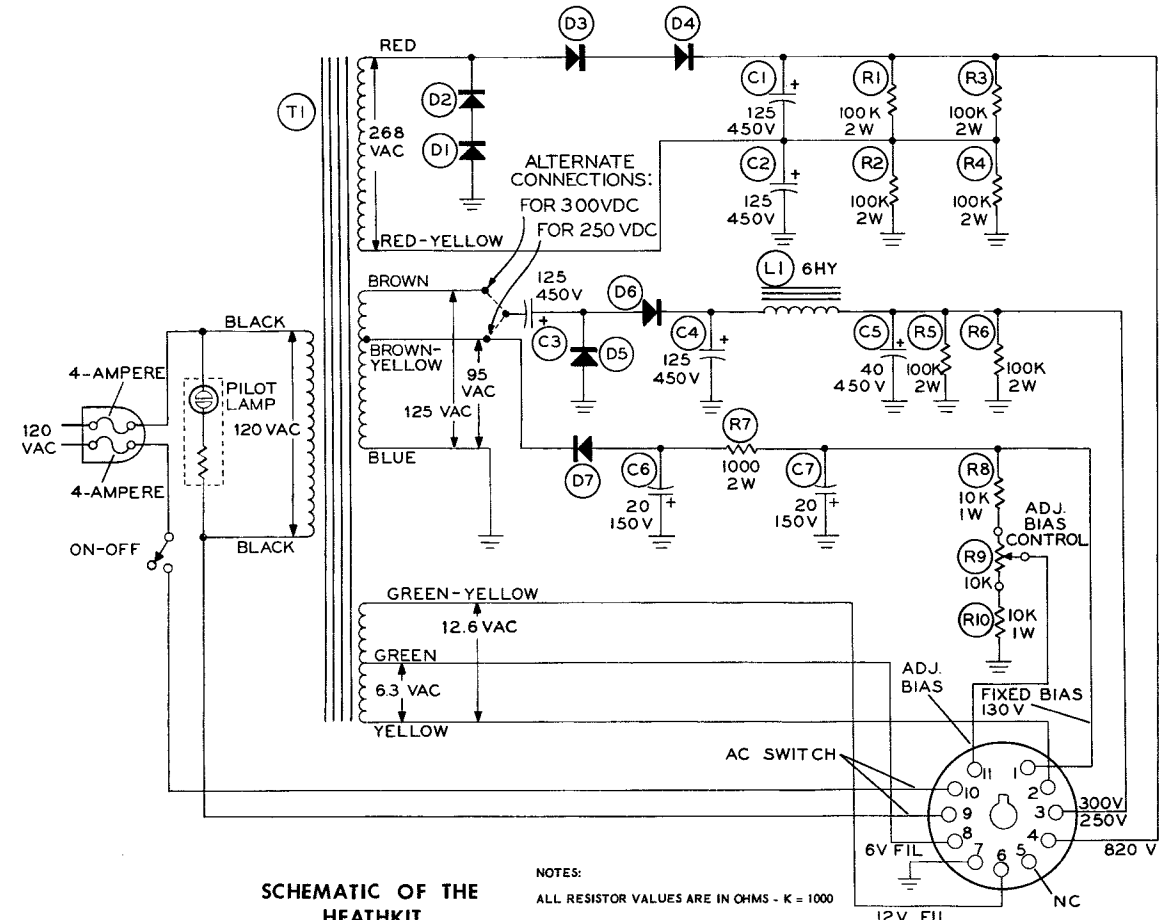

SCHMATIC OF THE HEATHKIT AC POWER SUPPLY MODEL HP-23

NOTES:
 ALL RESISTOR VALUES ARE IN OHMS - K = 1000
 ALL CAPACITORS IN μ fd.
 ALL DC VOLTAGES MEASURED FROM POINT INDICATED TO GROUND.
 VOLTAGES MADE WITH 11 MEGOHM INPUT VTVM.

STEP-BY-STEP PROCEDURE

The following instructions are presented in a logical step-by-step sequence to enable you to complete your kit with the least possible confusion. Be sure to read each step all the way through before beginning the specified operation. Also read several steps ahead of the actual step being performed. This will familiarize you with the relationship of the subsequent operations. When the step is completed, check it off in the space provided. This is particularly important as it may prevent errors or omissions, especially if your work is interrupted. Some kit builders have also found it helpful to mark each wire and part in colored pencil on the Pictorial as it is added.

ILLUSTRATIONS

The fold-out diagrams in this manual may be removed and attached to the wall above your working area; but because they are an integral part of the instructions, they should be returned to the manual after the kit is completed.

In general, the illustrations in this manual correspond to the actual configuration of the kit; however, in some instances the illustrations may be slightly distorted to facilitate clearly showing all of the parts.

SOLDERING

The abbreviation "NS" indicates that a connection should not be soldered yet as other wires will be added. When the last wire is installed, the terminal should be soldered and the abbreviation "S" is used to indicate this. Note that a number will appear after each solder instruction. This number indicates the number of leads that are supposed to be connected to the terminal in point before it is soldered. For example, if the instruction reads, "Connect a wire to lug 1 (S-2)," it will be understood that there will be two wires connected to the terminal at the time it is soldered. (In cases where a wire passes through a terminal or lug and then connects to another point, it will count as two wires, one entering and one leaving the terminal.)

GENERAL

The steps directing the installation of resistors include color codes to help identify the parts. Also, if a part is identified by a letter-number designation (R1, C1, etc.) on the Schematic, its designation will appear at the beginning of the assembly step which directs its installation.

STEP-BY-STEP ASSEMBLY

Refer to Pictorial 1 for the following steps.

- () Refer to Detail 1A and mount the 11-pin power socket at A on the chassis. Use the power socket mounting ring.

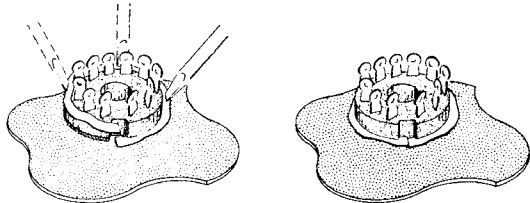

HOLD THE SOCKET IN THE CHASSIS HOLE AND PLACE ONE END OF THE RING INTO THE GROOVE OF THE SOCKET. USING A SCREWDRIVER, PRESS THE RING INTO THE GROOVE AROUND THE SOCKET.

Detail 1A

- () Install the 3/8" rubber grommet at B.
- () Install the 5/16" rubber grommet at L.
- () Mount a #6 solder lug at K. Use a 6-32 x 3/8" screw and a 6-32 nut. Position the solder lug as shown.
- () Referring to Detail 1B, mount a metal capacitor mounting wafer on top of the chassis at F and the 6-lug terminal strip on the bottom of the chassis at G. Use 6-32 x 3/8" screws, #6 lockwashers, and 6-32 nuts.
- () Mount the other metal capacitor mounting wafer on top of the chassis at H. Use 6-32 x 3/8" screws, #6 lockwashers, and 6-32 nuts.

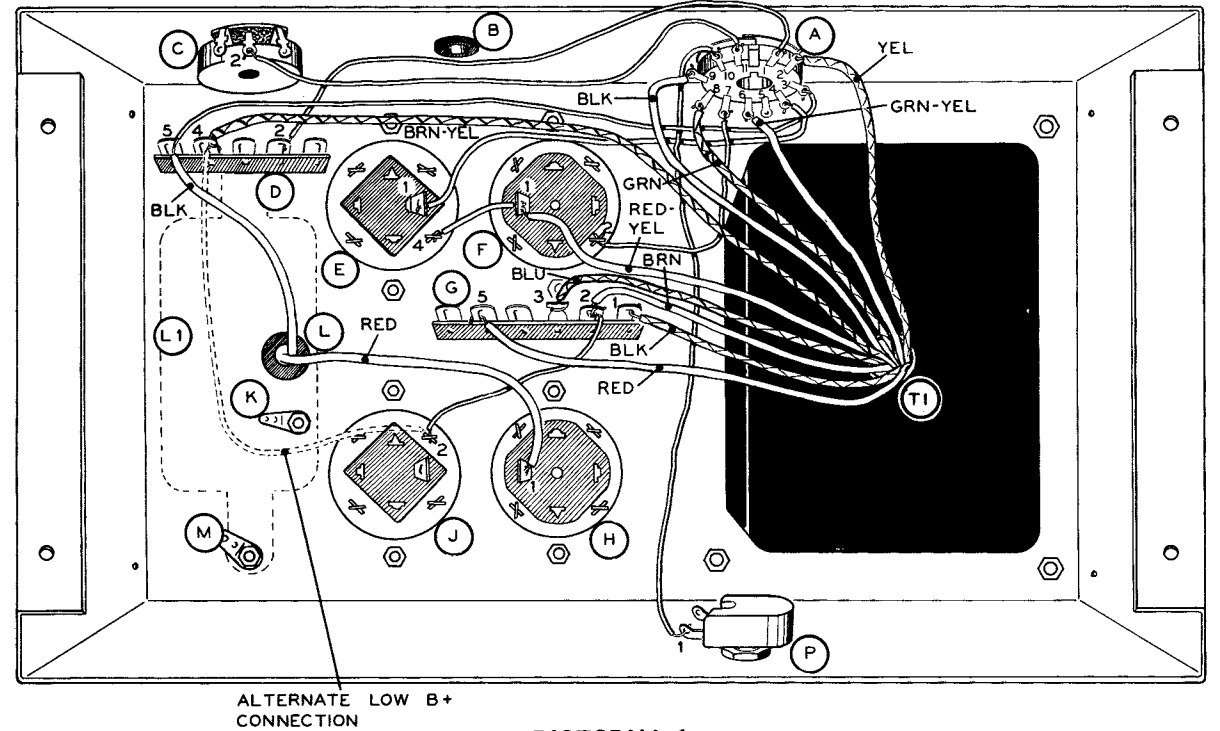

PICTORIAL 1

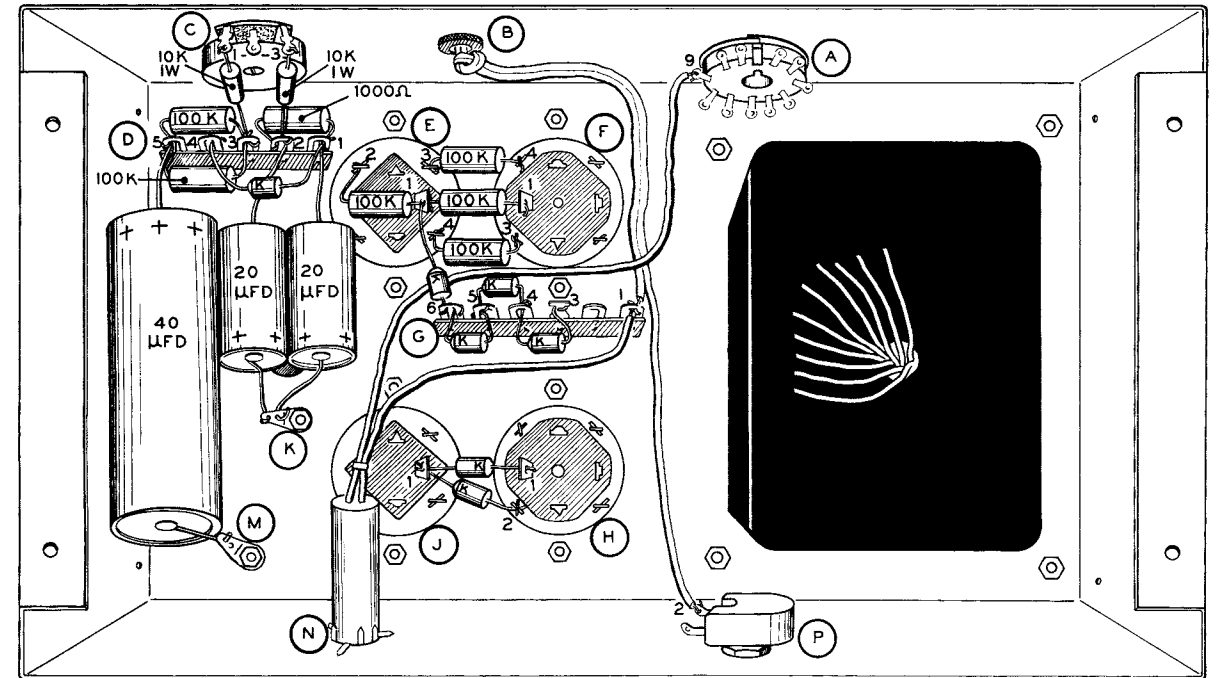

PICTORIAL 2

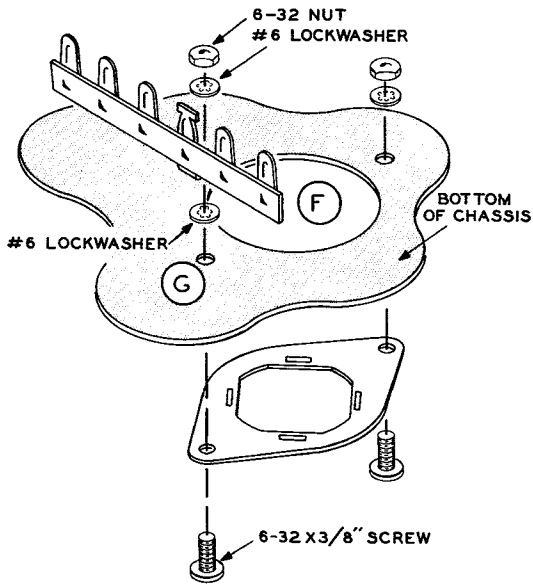

Detail 1B

- () L1. mount the filter choke (#46-22) on top of the chassis at L1 with a #8 solder lug at M and the prepared 5-lug terminal strip at D on the bottom of the chassis. Use 8-32 x 3/8" screws, #8 lockwashers, and 8-32 nuts as shown in Detail 1D. Place the red and black choke leads through grommet L. Bend the solder lug up away from the chassis.

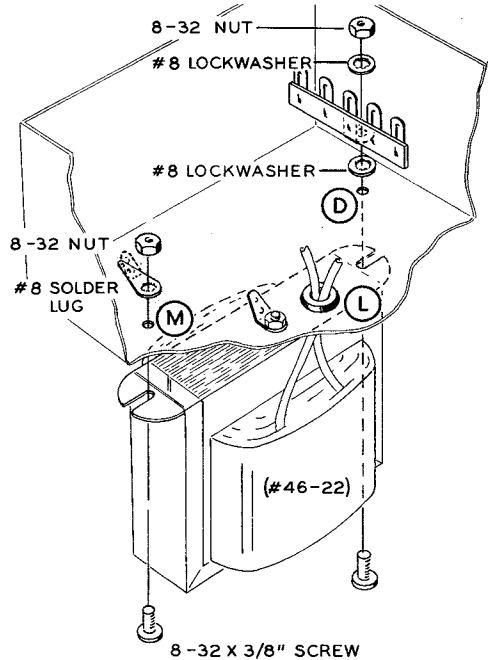

Detail 1D

- () Mount the insulated capacitor mounting wafers on top of the chassis at E and J. Use 6-32 x 3/8" screws, #6 lockwashers, and 6-32 nuts.
- () Prepare the mounting foot of a 5-lug terminal strip by clipping the front of the foot in half with diagonal cutters as shown in Detail 1C. Now separate the mounting foot until an 8-32 x 3/8" screw will fit through the hole in the foot.

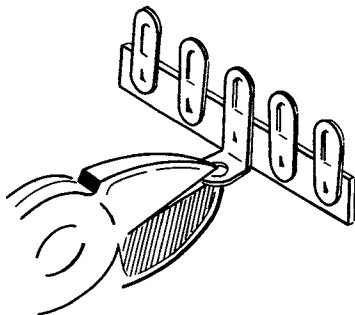

Detail 1C

- () R9. Refer to Detail 1E and mount the 10 KΩ twist control (#10-57) at C. Secure the control by twisting each mounting tab 1/4 turn. Position the control lugs as shown in Pictorial 1.

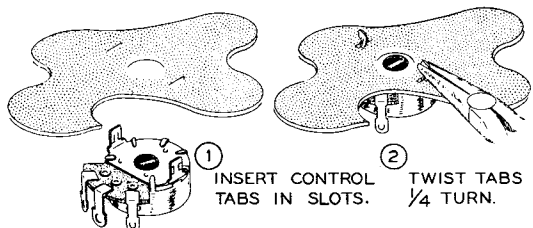

Detail 1E

() Cut the power transformer leads to the following lengths.

| <u>LEAD COLOR</u> | <u>LENGTH</u> |
|-------------------|---------------|
| Brown-yellow | do not cut |
| Red | 4-1/2" |
| Red-yellow | 4-1/2" |
| Blue | 4" |
| Brown | 3-3/4" |
| Green-yellow | 3-1/4" |
| Green | 3" |
| Yellow | 3" |
| Either black | 3" |
| Other black | 2-3/4" |

- () Remove 1/4" of insulation from the end of each lead and melt a small amount of solder on the exposed lead ends to hold the wire strands together.
- () T1. Mount the power transformer on top of the chassis at T1. Use #8 lockwashers and 8-32 nuts.
- () Remove one nut from the SPST toggle switch. Turn the other nut until it is 1/8" from the front of the switch. See Detail 1F. Now mount the switch at P with the switch lockwasher and the nut removed previously. Position the switch lugs as shown in Pictorial 1.

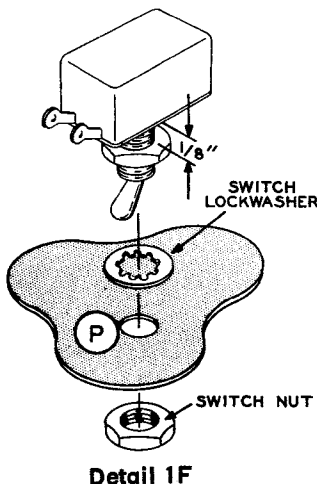

Detail 1F

() C1, C2, C3, C4. Refer to Detail 1G and mount the four 125 μ f electrolytic capacitors (#25-34) at F, H, E, and J. Position the capacitors with the lug markings as shown in Pictorial 1. Secure each capacitor by twisting each mounting lug 1/8 turn.

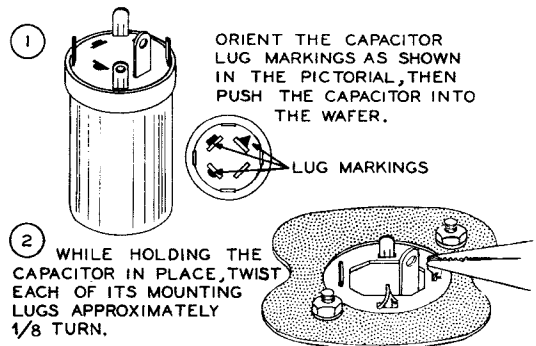
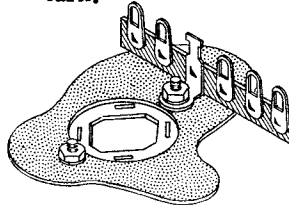

Detail 1G

Connect the power transformer leads as follows:

| <u>LEAD COLOR</u> | <u>CONNECT TO</u> |
|-------------------|---|
| () Red | lug 5 of terminal strip G (NS). |
| () Blue | lug 3 of terminal strip G (NS). |
| () Brown | lug 2 of terminal strip G (NS). |
| () 3" black | lug 1 of terminal strip G (NS). |
| () Red-yellow | lug 1 of electrolytic capacitor F (NS). |
| () Brown-yellow | lug 4 of terminal strip D (NS). Route as shown in Pictorial 1. |
| () Green-yellow | lug 6 of power socket A (S-1). |
| () Green | lug 8 of power socket A (S-1). |
| () 2-3/4" black | lug 9 of power socket A (NS). |
| () Yellow | lug 2 of power socket A (S-1). |

NOTE: Before making connections in the next two steps, prepare the ends of the choke leads as follows. Cut the choke leads to proper length, strip 1/4" insulation from the lead ends, and then apply a small amount of solder to the bare ends to hold the wire strands together.

- () Connect the red choke lead coming from grommet L to lug 1 of electrolytic capacitor H (NS).
- () Connect the black choke lead coming from grommet L to lug 5 of terminal strip D (NS).
- () Cut an 8" length of the 8-conductor cable. Refer to Detail 1H and remove the individual conductors from this 8" cable. These wires will be used for hookup wire in the following steps. When preparing a length of hookup wire, strip 1/4" of insulation from each end.

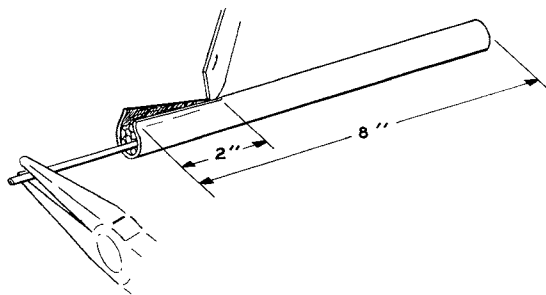

Detail 1H

- () Connect a 1-1/2" red wire from lug 1 of electrolytic capacitor F (NS) to lug 4 of electrolytic capacitor E (NS).
- () Connect a 5" red wire from lug 4 of power socket A (S-1) to lug 1 of electrolytic capacitor E (NS).
- () Connect a 7-3/4" orange wire from lug 3 of power socket A (S-1) to lug 5 of terminal strip D (NS).
- () Connect a 6-3/4" yellow wire from lug 1 of power socket A (S-1) to lug 2 of terminal strip D (NS).
- () Connect a 2-3/8" brown wire from lug 7 of power socket A (S-1) to lug 2 of electrolytic capacitor F (S-1).

- () Connect a 7" green wire from lug 11 of power socket A (S-1) to lug 2 of control C (S-1).
- () Connect a 6-3/4" black wire from lug 10 of power socket A (S-1) to lug 1 of switch P (S-1).

NOTE: At this time it will be necessary for you to determine the amount of low B+ voltage that will be required to operate your equipment. Then perform one of the two following steps, depending on the voltage required.

WIRING FOR 300 VOLTS LOW B+

- () Connect a 2-1/4" blue wire from lug 2 of electrolytic capacitor J (S-1) to lug 2 of terminal strip G (S-2).

WIRING FOR 250 VOLTS LOW B+

- () Solder lug 2 of terminal strip G (S-1).
- () Connect a 5-1/2" blue wire from lug 2 of electrolytic capacitor J (S-1) to lug 4 of terminal strip D (NS).

Refer to Pictorial 2 (fold-out from Page 8) for the following steps.

NOTE: All resistors used are 2 watt unless specified otherwise in the steps.

- () R2. Connect a 100 KΩ (brown-black-yellow) resistor from lug 4 of electrolytic capacitor F (S-1) to lug 3 of electrolytic capacitor E (S-1). Apply enough heat and solder to lug 4 of F to solder the lug to the mounting wafer.
- () R4. Connect a 100 KΩ (brown-black-yellow) resistor from lug 3 of electrolytic capacitor F (S-1) to lug 4 of electrolytic capacitor E (S-2).
- () R1. Connect a 100 KΩ (brown-black-yellow) resistor from lug 1 of electrolytic capacitor F (S-3) to lug 1 of electrolytic capacitor E (NS).
- () R3. Connect a 100 KΩ (brown-black-yellow) resistor between lugs 1 (NS) and 2 (S-1) of electrolytic capacitor E.

- () R6. Connect a 100 K Ω (brown-black-yellow) resistor between lugs 3 (NS) and 5 (NS) of terminal strip D. Place this resistor between the rear of the chassis and the terminal strip as shown in Pictorial 2. Be sure that it clears the screw hole in the end of the chassis.
- () R5. Connect the remaining 100 K Ω (brown-black-yellow) resistor between lugs 3 (NS) and 5 (NS) of terminal strip D. Position this resistor as shown.
- () R7. Connect a 1000 Ω (brown-black-red) resistor between lugs 1 (NS) and 2 (NS) of terminal strip D.
- () R10. Connect a 10 K Ω (brown-black-orange) 1 watt resistor from lug 1 of control C (S-1) to lug 3 of terminal strip D (S-3).
- () R8. Connect a 10 K Ω (brown-black-orange) 1 watt resistor from lug 3 of control C (S-1) to lug 2 of terminal strip D (NS).
- () C7. Connect the positive (+) lead of a 20 μ fd 150 V electrolytic capacitor to solder lug K (NS) and the other lead to lug 2 of terminal strip D (S-4). Route the lead to lug 2 of D under the diode lead. Bend it so that it does not touch the diode lead.
- () C6. Connect the positive (+) lead of another 20 μ fd 150 V electrolytic capacitor to solder lug K (S-2) and the other lead to lug 1 of terminal strip D (S-3).
- () D4. Connect the cathode (K) lead of a silicon diode to lug 1 of electrolytic capacitor E (S-4) and the other lead to lug 6 of terminal strip G (NS).
- () D3. Connect the cathode (K) lead of a silicon diode to lug 6 (S-2) and the other lead to lug 5 (NS) of terminal strip G.
- () D2. Connect the cathode (K) lead of a silicon diode to lug 5 (S-3) and the other lead to lug 4 (NS) of terminal strip G.

NOTE: Refer to Detail 2A in the following steps to determine the proper polarity of the silicon diodes. Be sure the diodes are installed as specified to prevent damage to them and related components.

NOTE: WHEN INSTALLING SILICON DIODES, THE CATHODE END SHOULD BE PLACED AS DIRECTED. THE CATHODE END IS MARKED WITH EITHER COLOR END, COLOR DOT, OR COLOR BAND. IN THE ILLUSTRATION, THE SYMBOL K INDICATES THE CATHODE END.

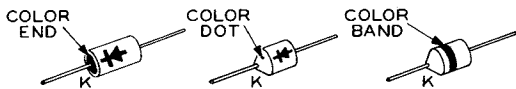

Detail 2A

- () D7. Connect the cathode (K) lead of a silicon diode to lug 4 of terminal strip D (S-2 or S-3, depending upon your choice of low B+ voltage). Connect the other diode lead to lug 1 of terminal strip D (NS).
- () C5. Connect the positive (+) lead of the 40 μ fd 450 V electrolytic capacitor to lug 5 of terminal strip D (S-5). Connect the other capacitor lead to solder lug M (S-1). Position the capacitor away from the chassis end to clear the top cover screws when they are installed later.
- () D5. Connect the cathode (K) lead of a silicon diode to lug 1 of electrolytic capacitor H (S-2) and the other lead to lug 1 of electrolytic capacitor J (NS).
- () D6. Connect the cathode (K) lead of a silicon diode to lug 1 of electrolytic capacitor J (S-2) and the other lead to lug 2 of electrolytic capacitor H (S-1). Apply enough heat and solder to lug 2 of H to solder it to the mounting wafer.
- () Refer to Detail 2B and mount the pilot lamp at N. Bend three of the spring tabs over as shown, to hold the pilot lamp in place.

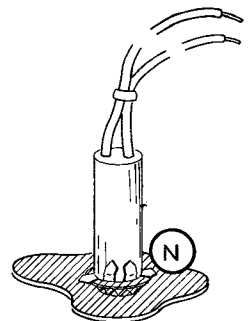

Detail 2B

NOTE: Before making connections in the next two steps, cut the pilot lamp leads to proper length, strip 1/4" of insulation from the lead ends, and then apply a small amount of solder to the bare ends to hold the wire strands together.

- () Connect either pilot lamp lead to lug 1 of terminal strip G (NS).
- () Connect the other pilot lamp lead to lug 9 of power socket A (S-2). Route this lead under the diode lead which goes to lug 6 of terminal strip G.
- () Refer to Detail 2C and prepare the line cord by tying a knot 6-1/2" from one end. Separate this end of the line cord 3-1/2" and cut off 3-1/4" from one of the leads. Remove 1/4" of insulation from both lead ends and melt a small amount of solder on the exposed ends to hold the wire strands together.

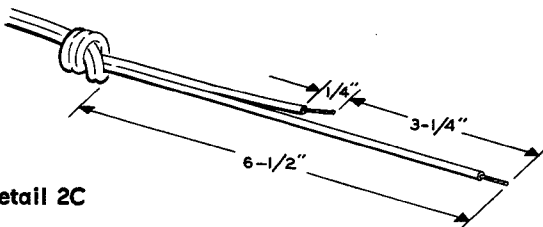

Detail 2C

- () Place the unprepared end of the line cord through grommet B from inside the chassis.
- () Connect the shorter lead of the line cord to lug 1 of terminal strip G (S-3) and the other line cord lead to lug 2 of switch P (S-1).
- () Refer to Detail 2D and install the fused plug on the free end of the line cord.

Refer to Pictorial 3 for the following steps.

- () Mount a rubber foot in each corner of the bottom plate. Use 8-32 x 3/8" screws, #8 lockwashers, and 8-32 nuts.

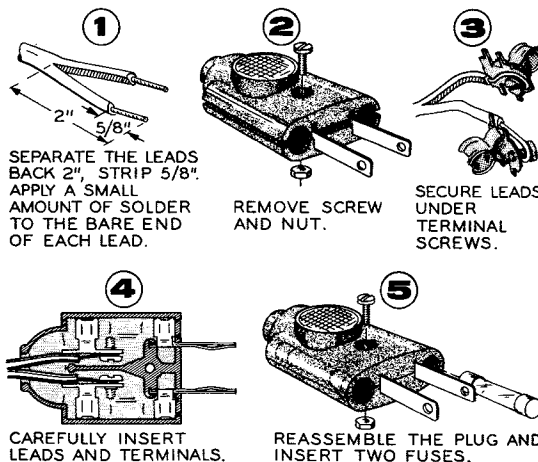

Detail 2D

- () Mount the bottom plate to the chassis with four #6 sheet metal screws.
- () Install the top cover on the chassis and secure it with four #6 sheet metal screws.

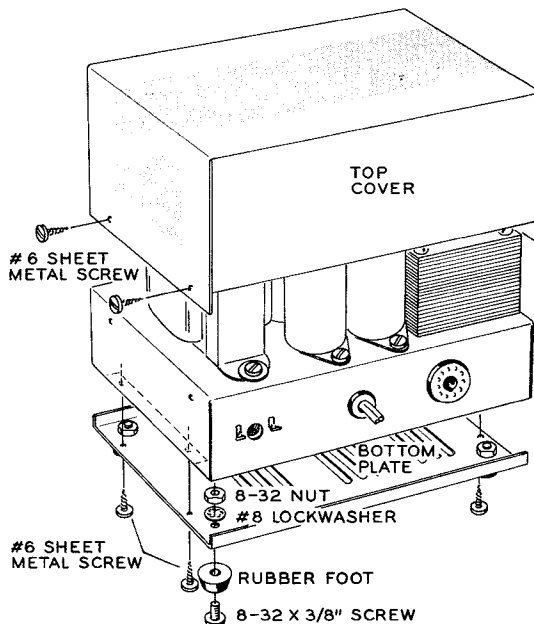

PICTORIAL 3

Refer to Pictorial 4 for the following steps.

- () Refer to Detail 4A and prepare one end of the 8-conductor cable.

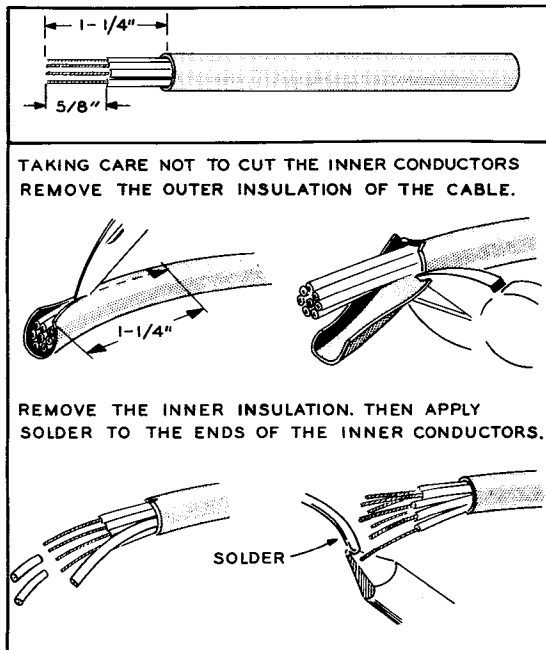

Detail 4A

- () Place the power plug cap over the prepared end of the cable and connect the cable wires to the plug as follows:

NOTE: Do not connect the brown and blue leads to pins 9 and 10 if this Power Supply is going to be used with the MT-1/MR-1 or HX-20/HR-20 transmitter/receiver combination.

If this Power Supply is to be used with the Heath HX-20 Transmitter, change R92 in the HX-20 from a 3900 Ω 1 watt resistor to a 2700 Ω 1 watt resistor.

| WIRE COLOR | TO PIN |
|------------|---------|
| () Black | 2 (S-1) |
| () Orange | 3 (S-1) |
| () Yellow | 4 (S-1) |
| () White | 7 (S-1) |
| () Brown | 9 (S-1) |

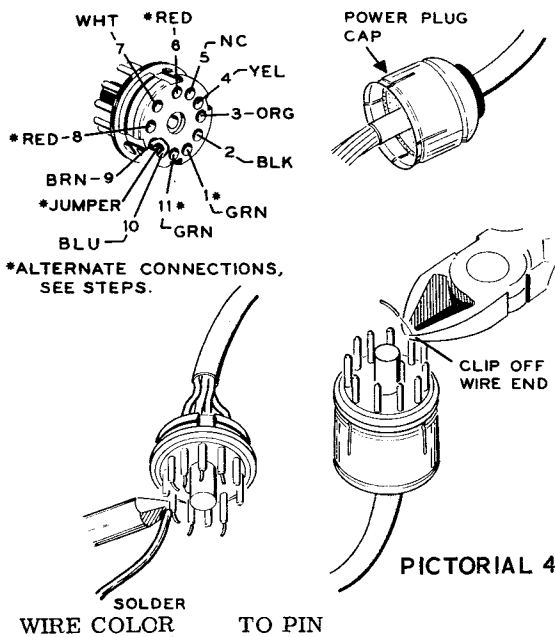

PICTORIAL 4

- () Blue 10 (S-1).
- () Green... pin 1 (S-1) for -130 volts bias, or pin 11 (S-1) for adjustable bias.
- () Red pin 6 (S-1) for 12 volts filament, or pin 8 (S-1) for 6 volt filaments.

NOTE: If more than 6 amperes of filament current will be drawn under 6 volt operation, parallel the red cable wire with a length of #18 wire.

NOTE: If this Power Supply is to be used with equipment that does not have provisions for switching the AC primary winding of the Power Supply, install a jumper wire between pins 9 (S-1) and 10 (S-1) of the power plug. Be sure that the brown and blue cable wires are not connected to these pins.

If this Power Supply is to be used with equipment that does have provisions for switching the AC primary winding of the Power Supply, the jumper is not used between pins 9 and 10. In this case, the brown cable wire should be connected to pin 9 (S-1) and the blue cable wire to pin 10 (S-1) of the power plug.

- () Snap the power plug cap onto the plug.

NOTE: The blue and white identification label shows the Model Number and Production Series Number of your kit. Refer to these numbers in

any communications with the Heath Company; this assures you that you will receive the most complete and up-to-date information in return.

() Install the identification label in the following manner:

1. Select a location for the label where it can easily be seen when needed, but will not show when the unit is in oper-

ation. This location might be on the rear panel or the top of the chassis, or on the rear or bottom of the cabinet.

2. Carefully peel away the backing paper. Then press the label into position.

This completes the assembly of your Heathkit AC Power Supply. Refer to the Operation section of the manual.

OPERATION

CAUTION: The output voltage of this Power Supply can be lethal. Also the potential stored in the large capacitors is dangerous. Allow time for discharge through the bleeders before working on the Power Supply. The capacitors can be discharged more quickly, with the Power Supply turned off, by shorting the capacitor lugs to the chassis with a screwdriver blade. In a situation where electrical shock is a possibility, stand on some dry insulating material and work with one hand behind your back.

Connections at the free end of the 8-conductor cable from the Power Supply will depend on the requirements of the equipment to be powered. The voltages and connections available from the output socket are printed on the rear of the Power Supply. With the output power cable wired as directed in this manual, the voltages and connections available at the free end will be as shown in Figure 1. If a voltmeter is available, measure the voltages at the socket before connecting the Power Supply to other equipment.

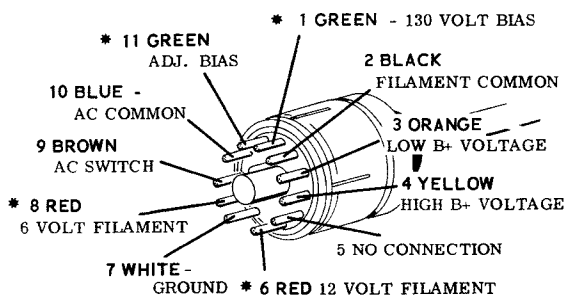

* ALTERNATE CONNECTIONS.

FIGURE 1

Once the Power Supply has been properly connected to the associated equipment, you can turn the complete system on and off with the OFF-ON switch in the Power Supply, or the switch in the Power Supply can be left ON and power can be switched with the off-on switch in the associated equipment. In either case, both plate and filament power are turned off and on simultaneously.

IN CASE OF DIFFICULTY

1. Recheck the wiring. Trace each lead in colored pencil on the Pictorial as it is checked. It is frequently helpful to have a friend check your work. Someone who is not familiar with the unit may notice something consistently overlooked by the constructor.
2. It is interesting to note that about 90% of the kits that are returned for repair, do not function properly due to poor connections and soldering. Therefore, many troubles can be eliminated by reheating all connections to make sure that they are soldered as described in the Proper Soldering Techniques section of this manual.
3. Check the values of the parts. Be sure that the proper part has been wired into the circuit, as shown in the pictorial diagrams and as called out in the wiring instructions.
4. Check for bits of solder, wire ends or other foreign matter which may be lodged in the wiring.
5. A review of the Circuit Description will prove helpful in indicating where to look for trouble.
6. If excessive current has been drawn from any section of the power supply, the fuse may be blown.



SERVICE INFORMATION

SERVICE

If, after applying the information in this manual and your best efforts, you are still unable to obtain proper performance, it is suggested that you take advantage of the technical facilities which the Heath Company makes available to its customers.

The Technical Consultation Department is maintained for your benefit. This service is available to you at no charge. Its primary purpose is to provide assistance for those who encounter difficulty in the construction, operation or maintenance of HEATHKIT equipment. It is not intended, and is not equipped to function as a general source of technical information involving kit modifications nor anything other than the normal and specified performance of HEATHKIT equipment.

Although the Technical Consultants are familiar with all details of this kit, the effectiveness of their advice will depend entirely upon the amount and the accuracy of the information furnished by you. In a sense, YOU MUST QUALIFY for GOOD technical advice by helping the consultants to help you. Please use this outline:

1. Before writing, fully investigate each of the hints and suggestions listed in this manual under In Case Of Difficulty. Possibly it will not be necessary to write.
2. When writing, clearly describe the nature of the trouble and mention all associated equipment. Specifically report operating procedures, switch positions, connections to other units, and anything else that might help to isolate the cause of trouble.
3. Report fully on the results obtained when testing the unit initially and when following the suggestions under In Case Of Difficulty. Be as specific as possible and include voltage readings if test equipment is available.

4. Identify the kit Model Number and Series Number, and date of purchase, if available. Also mention the date of the kit assembly manual. (Date at bottom of Page 1.)
5. Print or type your name and address, preferably in two places on the letter.

With the preceding information, the consultant will know exactly what kit you have, what you would like it to do for you and the difficulty you wish to correct. The date of purchase tells him whether or not engineering changes have been made since it was shipped to you. He will know what you have done in an effort to locate the cause of trouble and, thereby, avoid repetitious suggestions. In short, he will devote full time to the problem at hand, and through his familiarity with the kit, plus your accurate report, he will be able to give you a complete and helpful answer. If replacement parts are required, they will be shipped to you, subject to the terms of the Warranty.

The Factory Service facilities are also available to you, in case you are not familiar enough with electronics to provide our consultants with sufficient information on which to base a diagnosis of your difficulty, or in the event that you prefer to have the difficulty corrected in this manner. You may return the completed equipment to the Heath Company for inspection and necessary repairs and adjustments. You will be charged a minimal service fee, plus the price of any additional parts or material required. However, if the completed kit is returned within the Warranty period, parts charges will be governed by the terms of the Warranty. State the date of purchase, if possible.

Local Service by Authorized HEATHKIT Service Centers is also available in some areas and often will be your fastest, most efficient method of obtaining service. HEATHKIT Service Centers will honor the regular 90 day HEATHKIT Parts Warranty on all kits, whether purchased through a dealer or directly from the Heath Company; however, it will be necessary that you verify the purchase date of your kit.

Under the conditions specified in the Warranty, replacement parts are supplied without charge; however, if the Service Center assists you in locating a defective part (or parts) in your kit, or installs a replacement part for you, you may be charged for this service.

HEATHKIT equipment purchased locally and returned to Heath Company for service must be accompanied by your copy of the dated sales receipt from your authorized HEATHKIT dealer in order to be eligible for parts replacement under the terms of the Warranty.

THIS SERVICE POLICY APPLIES ONLY TO COMPLETED EQUIPMENT CONSTRUCTED IN ACCORDANCE WITH THE INSTRUCTIONS AS STATED IN THE MANUAL. Equipment that has been modified in design will not be accepted for repair. If there is evidence of acid core solder or paste fluxes, the equipment will be returned NOT repaired.

For information regarding modification of HEATHKIT equipment for special applications, it is suggested that you refer to any one or more of the many publications that are available on all phases of electronics. They can be obtained at or through your local library, as well as at most electronic equipment stores. Although the Heath Company sincerely welcomes all comments and suggestions, it would be impossible to design, test, evaluate and assume responsibility for proposed circuit changes for special purposes. Therefore, such modifications must be made at the discretion of the kit builder, using information available from sources other than the Heath Company.

REPLACEMENTS

Material supplied with HEATHKIT products has been carefully selected to meet design requirements and ordinarily will fulfill its function without difficulty. Occasionally, improper operation can be traced to a faulty component. Should inspection reveal the necessity for replacement, write to the Heath Company and supply all of the following information.

A. Thoroughly identify the part in question by using the part number and description found in the manual Parts List.

B. Identify the kit Model Number and Series Number.

C. Mention date of purchase.

D. Describe the nature of defect or reason for requesting replacement.

The Heath Company will promptly supply the necessary replacement. PLEASE DO NOT RETURN THE ORIGINAL COMPONENT UNTIL SPECIFICALLY REQUESTED TO DO SO. Do not dismantle the component in question as this will void the guarantee. This replacement policy does not cover the free replacement of parts that may have been broken or damaged through carelessness on the part of the kit builder.

SHIPPING INSTRUCTIONS

In the event that your instrument must be returned for service, these instructions should be carefully followed.

Wrap the equipment in heavy paper, exercising care to prevent damage. Place the wrapped equipment in a stout carton of such size that at least three inches of shredded paper, excelsior, or other resilient packing material can be placed between all sides of the wrapped equipment and the carton. Close and seal the carton with gummed paper tape, or alternately, tie securely with stout cord. Clearly print the address on the carton as follows:

To: HEATH COMPANY
Benton Harbor, Michigan 49022

ATTACH A LETTER TO THE OUTSIDE OF THE CARTON BEARING YOUR NAME, COMPLETE ADDRESS, DATE OF PURCHASE, AND A BRIEF DESCRIPTION OF THE DIFFICULTY ENCOUNTERED. Also, include your name and return address on the outside of the carton. Preferably affix one or more "Fragile" or "Handle With Care" labels to the carton, or otherwise so mark with a crayon of bright color. Ship by insured parcel post or prepaid express; note that a carrier cannot be held responsible for damage in transit if, in HIS OPINION, the article is inadequately packed for shipment.

WARRANTY

The Heath Company warrants that the parts supplied in its kits (except batteries) shall be free of defects in materials and workmanship under normal conditions of use and service. The obligation of Heath under this warranty is limited to replacing or repairing any such part upon verification that it is defective in this manner. This obligation is further limited to such defective parts for which Heath is notified of the defect within a period of ninety (90) days from the original date of shipment of the kit.

The obligation of Heath under this warranty does not include either the furnishing or the expense of any labor in connection with the installation of such repaired or replacement parts. The obligation of Heath with respect to transportation expenses is limited to the cost of shipping the repaired or replacement parts to the buyer, provided such repair or replacement comes within the terms of this warranty.

The foregoing warranty extends only to the original buyer and is expressly in lieu of all other warranties, expressed or implied. The foregoing warranty is further in lieu of all other obligations or liabilities on the part of Heath and in no event shall the Heath Company be liable for any anticipated profits, consequential damages, loss of time or other losses incurred by the buyer in connection with the purchase, assembly or use of the kit product or components thereof.

The foregoing warranty shall be deemed completely void if acid core solder or paste flux or other corrosive solders or fluxes have been used in assembling or repairing the kit product. Heath will not replace or repair any parts of any kit products in which such corrosive solders or fluxes have been used.

This warranty applies only to Heath products sold and shipped to points within the continental United States and to APO and FPO shipments. Warranty replacement for Heath products sold or shipped outside the United States is on an f.o.b. factory basis. Contact the Heath authorized distributor in your country or write: Heath Company, International Division, Benton Harbor, Michigan, U.S.A.

HEATH COMPANY

REPLACEMENT PARTS PRICE LIST

| <u>PART No.</u> | <u>PRICE Each</u> | <u>DESCRIPTION</u> | <u>PART No.</u> | <u>PRICE Each</u> | <u>DESCRIPTION</u> |
|--------------------------------------|-------------------|---|------------------------------------|-------------------|----------------------|
| RESISTORS-CAPACITORS | | | HARDWARE | | |
| 1-9-1 | .10 | 10 K Ω 1 watt resistor | 250-137 | .05 | 8-32 x 3/8" screw |
| 1-15-2 | .20 | 1000 Ω 2 watt resistor | 250-89 | .05 | 6-32 x 3/8" screw |
| 1-24-2 | .20 | 100 K Ω 2 watt resistor | 250-8 | .05 | #6 sheet metal screw |
| 25-19 | .55 | 20 μ fd 150 V electrolytic capacitor | 252-4 | .05 | 8-32 nut |
| 25-36 | 1.00 | 40 μ fd 450 V electrolytic capacitor | 252-3 | .05 | 6-32 nut |
| 25-34 | 2.10 | 125 μ fd 450 V electrolytic capacitor | 254-2 | .05 | #8 lockwasher |
| | | | 254-1 | .05 | #6 lockwasher |
| | | | 259-1 | .05 | #6 solder lug |
| | | | 259-2 | .05 | #8 solder lug |
| CONTROL-SWITCH-GROMMETS-CHOKE | | | TERMINAL STRIPS-SOCKET-PLUG | | |
| 10-57 | .35 | 10 K Ω twist-tab control | 431-11 | .10 | 5-lug terminal strip |
| 46-22 | 4.45 | Filter choke | 431-55 | .10 | 6-lug terminal strip |
| 61-1 | .80 | SPST toggle switch | 434-118 | .40 | Power socket |
| 73-1 | .10 | 3/8" rubber grommet | 438-11 | .70 | Fused plug |
| 73-4 | .10 | 5/16" rubber grommet | 438-29 | .40 | Power plug |

| <u>PART</u> <u>No.</u> | <u>PRICE</u> <u>Each</u> | <u>DESCRIPTION</u> | <u>PART</u> <u>No.</u> | <u>PRICE</u> <u>Each</u> | <u>DESCRIPTION</u> |
|---------------------------|-----------------------------|------------------------------------|--------------------------------|-----------------------------|------------------------------------|
| MISCELLANEOUS | | | Miscellaneous (cont'd.) | | |
| 54-143 | 9.55 | Power transformer | 435-1 | .10 | Power socket mounting ring |
| 57-27 | .60 | 500 ma, 500 volt PIV silicon diode | 440-1 | .20 | Power plug cap |
| 89-4 | .45 | Line cord | 481-1 | .10 | Metal capacitor mounting wafer |
| 100-538-1 | 1.35 | Top cover | 481-3 | .10 | Insulated capacitor mounting wafer |
| 200-384-1 | 1.70 | Chassis | 331-6 | .10 | Solder |
| 205-168-1 | .65 | Bottom plate | 595-635 | 2.00 | Manual |
| 261-6 | .10 | Rubber foot | | | |
| 347-18 | .15/ft | 8-conductor cable | | | |
| 412-10 | .85 | Pilot lamp | | | |
| 421-5 | .25 | 4-ampere fuse | | | |

The above prices apply only on purchases from the Heath Company where shipment is to a U.S.A. destination. Selling prices elsewhere in U.S.A. may be slightly higher to offset transportation and local taxes. Outside the U.S.A. parts and service are available from your local Heathkit source and will reflect additional transportation, taxes, duties and rates of exchange.