



Aluminum Capacitors

TRANSLATION OF TECHNICAL TERMS		
SOME IMPORTANT TERMS	DES TERMES IMPORTANTES	EINIGE WICHTIGE BEGRIFFE
Ambient temperature (T_{amb})	température ambiante	Umgebungstemperatur
Assessment level	niveau d'assurance	Gütebestätigungsstufe
Axial terminations	sorties axiales	axiale Anschlussdrähte
Capacitance	capacité	Kapazität
Charge	charge	laden
Climatic category	catégorie climatique	Klimakategorie
Dimensions	dimensions	Maße
Discharge	décharge	entladen
Dissipation factor ($\tan \delta$)	tangente de l'angle de pertes	Verlustfaktor
Endurance	endurance	Dauerspannungsprüfung
Equivalent series resistance (ESR)	résistance série équivalente	äquivalenter Serienwiderstand
Equivalent series inductance (ESL)	inductance série équivalente	äquivalente Serieninduktivität
Failure rate	taux de fiabilité	Ausfallrate
Frequency (f)	fréquence	Frequenz
General purpose grade	usage général	allgemeine Anforderungen
Impedance (Z)	impédance	Scheinwiderstand, Impedanz
Leadless	sans fils	unbedrahtet
Leakage current (I_L)	courant de fuite	Reststrom
Long life grade	longue durée de vie	erhöhte Anforderungen
Method	méthode	Verfahren
Mounting	montage	Montage
No visible damage	aucun dommage	keine sichtbaren Schäden
Open circuit	circuit ouvert	Unterbrechung
Mounting hole diagram	dessin de montage	Bohrungsraster
Rated capacitance (C_R)	capacité nominale	Nennkapazität
Rated voltage (U_R)	tension nominale	Nennspannung
Recovery	reprise	Nachbehandlung
Forming voltage (U_F)	tension de formation	Formierspannung
Requirements	exigences	Anforderungen
Reverse voltage (U_{rev})	tension inverse	Umpolspannung
Ripple current (I_R)	courant ondulé	überlagerter Wechselstrom
Short circuit	court-circuit	Kurzschluß
Surface mounting device (SMD)	composant pour montage en surface	oberflächenmontierbares Bauelement
Surge voltage (U_S)	surtension	Spitzenspannung
Terminal pitch	distance entre les connections	Rastermaß
Terminations	sorties	Anschlüsse
Useful life	durée de vie	Brauchbarkeitsdauer
Visual examination	examen visuel	Sichtkontrolle

CAPACITOR PRINCIPLES

The essential property of a capacitor is to store electrical charge. The amount of electrical charge (Q) in the capacitor (C) is proportional to the applied voltage (U). The relationship of these parameters is:

$$Q = C \times U$$

where:

Q = charge in coulombs (C)

C = capacitance in farads (F)

U = voltage in volts (V)

The value of capacitance is directly proportional to the (anode) surface area and inversely proportional to the thickness of the dielectric layer, thus:

$$C = \epsilon_0 \times \epsilon_r \times \frac{A}{d}$$

where:

ϵ_0 = absolute permittivity (8.85×10^{-12} F/m)

ϵ_r = relative dielectric constant (dimensionless)

A = surface area (m²)

d = thickness of the dielectric (oxide layer in aluminum capacitors) (m).

ENERGY CONTENT OF A CAPACITOR

The energy content of a capacitor is given by:

$$W_E = \frac{1}{2} \times C \times U^2$$

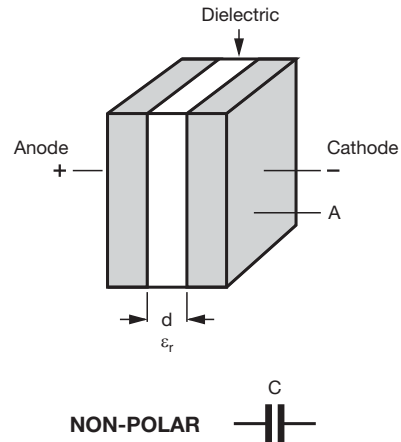
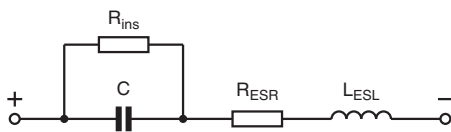

Fig. 1 - Equivalent circuit of an ideal capacitor



POLAR

Anode electrode:
Valve effect metal: Aluminum

Dielectric: Al₂O₃

Cathode electrode, solid or non-solid electrolyte depending on technology:
Non-solid: Wet electrolyte, spacer and aluminum foil
Solid: Solid electrolyte (e.g. manganese dioxide), graphite and silver epoxy

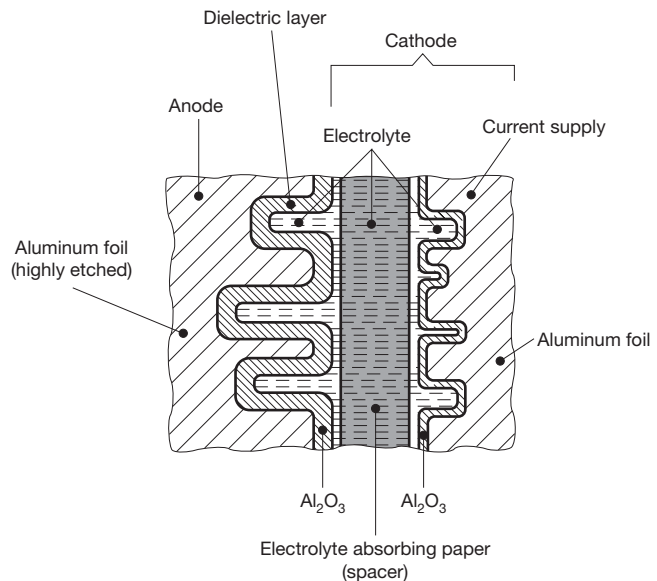

Fig. 2 - Equivalent circuit of an aluminum capacitor

ELECTRICAL BEHAVIOR

Characteristics of aluminum capacitors vary with temperature, time and applied voltage.

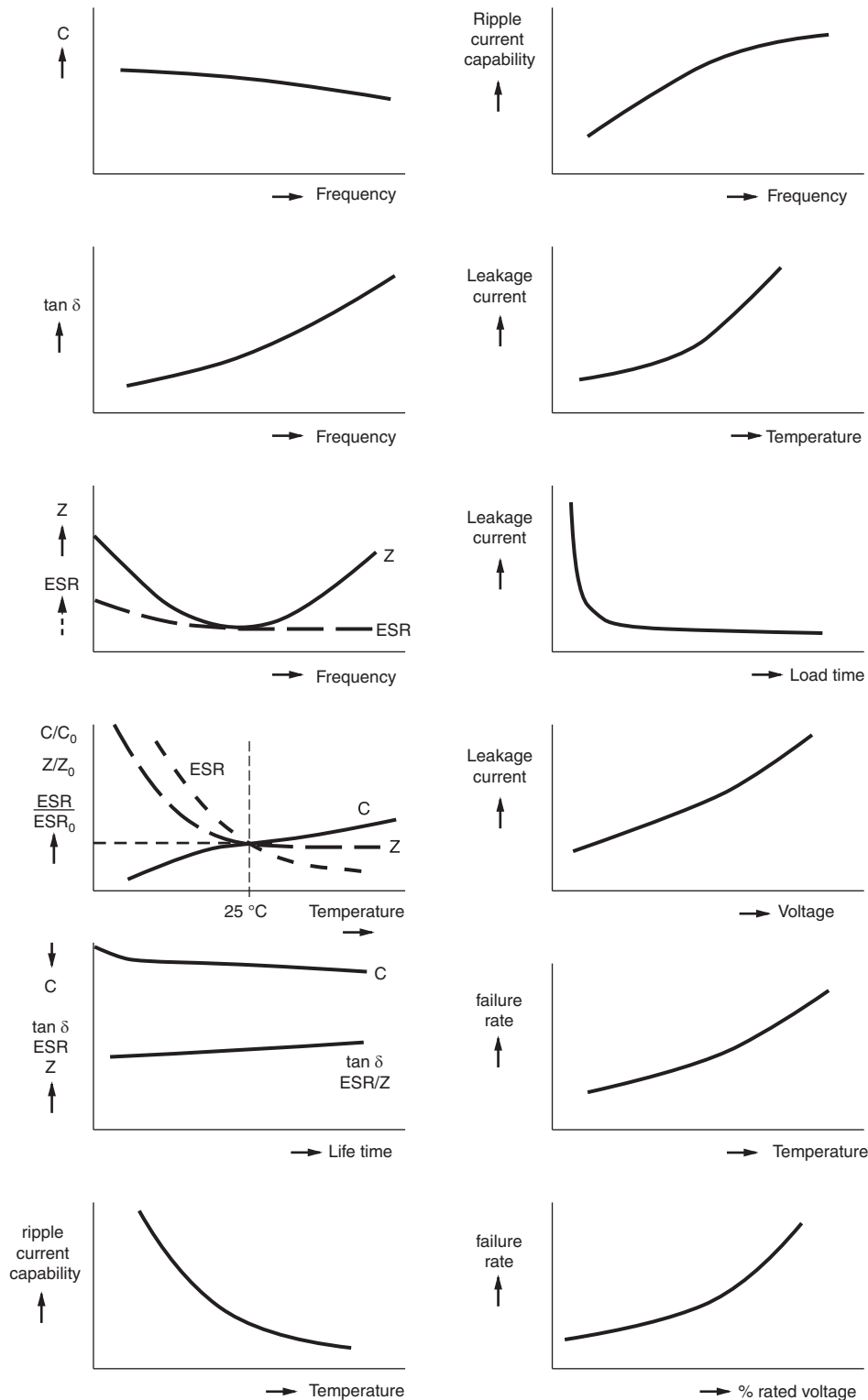

Fig. 3 - Typical variation of electrical parameters as a function of frequency, ambient temperature, voltage and time

CONSTRUCTION

Examples

Wound cell, consisting of:

- Aluminum foil anode with aluminum oxide dielectric
- Paper spacer impregnated with electrolyte
- Aluminum foil cathode

Flattened cathode lead

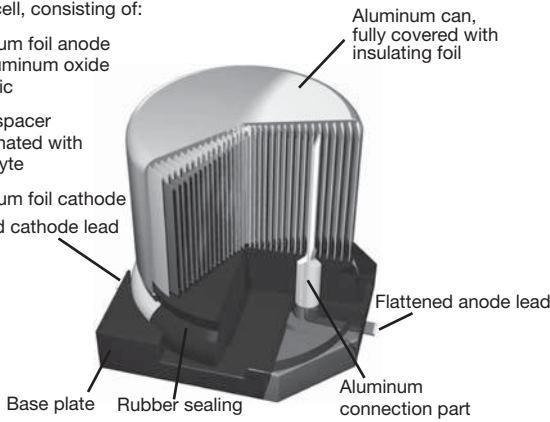

Fig. 4 - Surface mount device (vertical style)

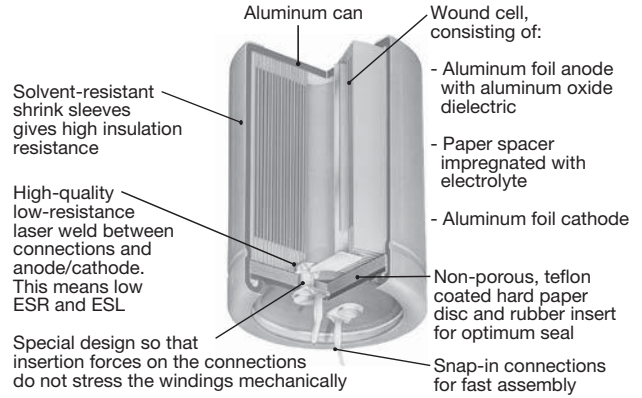

Fig. 7 - Large aluminum, snap-in

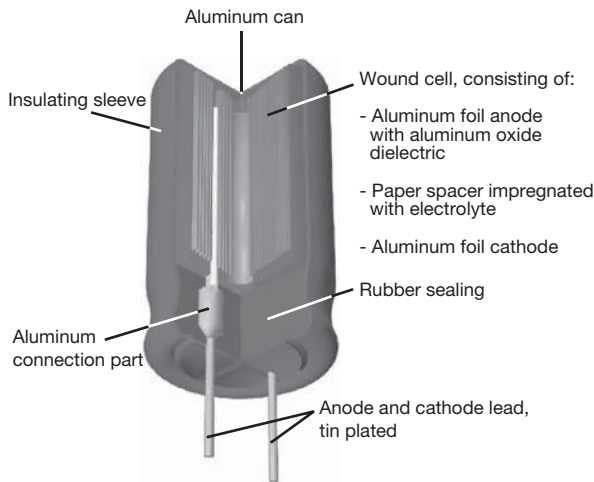

Fig. 5 - Radial aluminum

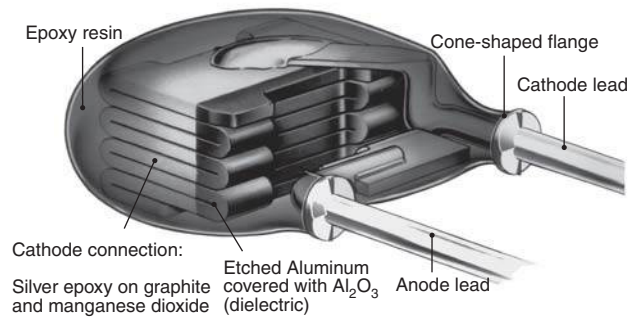

Fig. 8 - Solid aluminum (SAL), radial

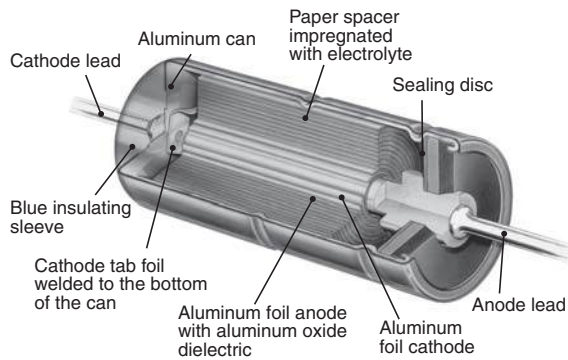

Fig. 6 - Axial aluminum

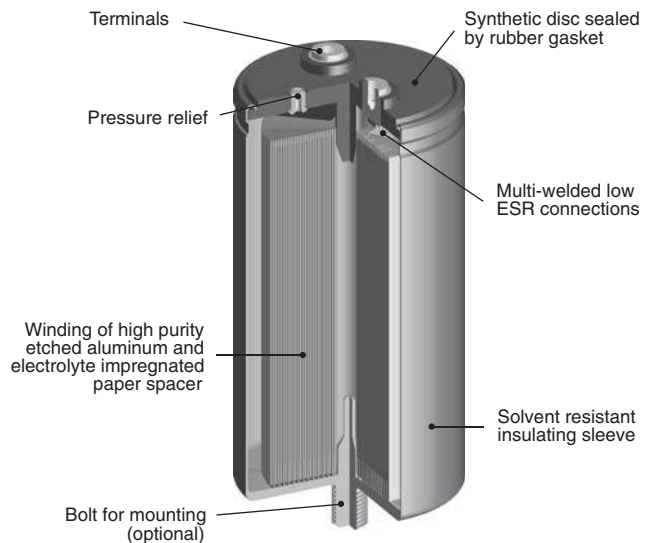

Fig. 9 - Large aluminum, screw terminal

DEFINITIONS OF ELECTRICAL PARAMETERS

Sequence of measurement for tests are in accordance with "IEC 60384-4":

1. Leakage current (I_L)
2. Capacitance (C_R)
3. Dissipation factor ($\tan \delta$ or ESR)
4. Impedance (Z)

CAPACITANCE

AC CAPACITANCE OF AN ALUMINUM CAPACITOR

The capacitance of an equivalent circuit, having capacitance, resistance and inductance in series, measured with alternating current of approximately sinusoidal waveform at a specified frequency; refer to Fig. 10.

Standard measuring frequencies for aluminum capacitors are 100 Hz or 120 Hz.



Fig. 10 - AC equivalent circuit of an aluminum capacitor

DC CAPACITANCE OF AN ALUMINUM CAPACITOR (FOR TIMING CIRCUITS)

DC capacitance is given by the amount of charge which is stored in the capacitor at the rated voltage (U_R).

DC capacitance is measured by a single discharge of the capacitor under defined conditions. Measuring procedures are described in "DIN 41328, sheet 4" (withdrawn).

At any given time, the DC capacitance is higher than the AC capacitance.

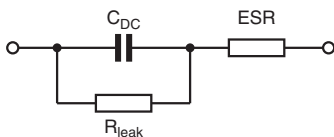

Fig. 11 - DC equivalent circuit of an aluminum capacitor

RATED CAPACITANCE (C_R)

The capacitance value for which the capacitor has been designed and which is usually indicated upon it.

Preferred values of rated capacitance and their decimal multiples are preferably chosen from the E3 series of "IEC Publication 60063".

TOLERANCE ON RATED CAPACITANCE

Preferred values of tolerances on rated capacitance:

-20 % / +20 %	-10 % / +50 %	-10 % / +30 %	-10 % / +10 %
M	T	Q	K

These values depend on the relevant series.

VOLTAGE

RATED VOLTAGE (U_R)

The maximum DC voltage, or peak value of pulse voltage which may be applied continuously to a capacitor at any temperature between the lower category temperature and the rated temperature.

CATEGORY VOLTAGE (U_C)

The maximum voltage which may be applied continuously to a capacitor at its upper category temperature.

TEMPERATURE DERATED VOLTAGE

The temperature derated voltage is the maximum voltage that may be applied continuously to a capacitor, for any temperature between the rated temperature and the upper category temperature.

RIPPLE VOLTAGE (U_{RPL})

An alternating voltage may be applied, provided that the peak voltage resulting from the alternating voltage, when superimposed on the DC voltage, does not exceed the value of rated DC voltage or fall under 0 V and that the ripple current is not exceeded.

REVERSE VOLTAGE (U_{REV})

The maximum voltage applied in the reverse polarity direction to the capacitor terminations.

SURGE VOLTAGE (U_S)

The maximum instantaneous voltage which may be applied to the terminations of the capacitor for a specified time at any temperature within the category temperature range.

TEMPERATURE

CATEGORY TEMPERATURE RANGE

The range of ambient temperatures for which the capacitor has been designed to operate continuously: this is defined by the temperature limits of the appropriate category.

RATED TEMPERATURE

The maximum ambient temperature at which the rated voltage may be continuously applied.

MINIMUM STORAGE TEMPERATURE

The minimum permissible ambient temperature which the capacitor shall withstand in the non-operating condition, without damage.

RESISTANCE / REACTANCE

EQUIVALENT SERIES RESISTANCE (ESR)

The ESR of an equivalent circuit having capacitance, inductance and resistance in series measured with alternating current of approximately sinusoidal waveform at a specified frequency; refer to Fig. 10.

EQUIVALENT SERIES INDUCTANCE (ESL)

The ESL of an equivalent circuit having capacitance, resistance and inductance in series measured with alternating current of approximately sinusoidal waveform at a specified frequency; refer to Fig. 10.

DISSIPATION FACTOR (TANGENT OF LOSS ANGLE; $\tan \delta$)

The power loss of the capacitor divided by the reactive power of the capacitor at a sinusoidal voltage of specified frequency. The dissipation factor can be approximated by following formula:

$$\tan \delta = \text{ESR} \times 2\pi fC$$

IMPEDANCE (Z)

The impedance (Z) of an aluminum capacitor is given by capacitance, ESR and ESL in accordance with the following equation (see Fig. 12):

$$Z = \sqrt{\text{ESR}^2 + \left(2\pi f\text{ESL} - \frac{1}{2\pi fC}\right)^2}$$

CURRENT

LEAKAGE CURRENT (I_L)

The DC current flowing through a capacitor when a DC voltage is applied in correct polarity. It is dependent on voltage, temperature and time.

LEAKAGE CURRENT FOR ACCEPTANCE TEST (I_{L5})

In accordance with international standards ("IEC 60384-4" and "EN130300") the leakage current (I_{L5}) after 5 min application of rated voltage at 20 °C is considered as an acceptance requirement.

The leakage current requirements for the majority of Vishay BCcomponents aluminum capacitors, are lower than specified in "IEC 60384-4" or "EN130300".

If, for example, after prolonged storage and / or storage at excessive temperature (> 40 °C), the leakage current at the first measurement does not meet the requirements, pre-conditioning shall be carried out in accordance with "EN130300 subclause 4.1".

LEAKAGE CURRENT AT DELIVERY (I_{L1} or I_{L2})

In addition to I_{L5} , the leakage current after 1 min application of rated voltage (I_{L1}) is specified in most of the detail specifications.

For some series this value is specified after 2 min (I_{L2}).

OPERATIONAL LEAKAGE CURRENT (I_{OP})

After continuous operation (1 h or longer) the leakage current will normally decrease to less than 20 % of the 5 min value (I_{L5}).

The operational leakage current depends on applied voltage and ambient temperature; see Tables 1 and 2.

LEAKAGE CURRENT AFTER STORAGE WITH NO VOLTAGE APPLIED (SHELF LIFE)

If non-solid aluminum capacitors are stored above room temperature for long periods of time, the oxide layer may react with the electrolyte, causing increased leakage current when switched on for the first time after storage.

Table 1

TYPICAL MULTIPLIER OF OPERATIONAL LEAKAGE CURRENT AS A FUNCTION OF AMBIENT TEMPERATURE											
SYMBOL	MULTIPLIER ⁽¹⁾										
T_{amb} (°C)	-55	-40	-25	0	20	45	65	85	105	125	150
I_{OP}/I_L	< 0.5	0.5	0.6	0.8	1	1.5	2.5	4	7	10	15

Note

⁽¹⁾ As far as allowed for the corresponding series

Table 2

TYPICAL MULTIPLIER OF OPERATIONAL LEAKAGE CURRENT AS A FUNCTION OF APPLIED VOLTAGE									
SYMBOL	MULTIPLIER								
U/U_R	< 0.2	0.3	0.4	0.5	0.6	0.7	0.8	0.9	1.0
I_{OP}/I_L	0.1	0.15	0.2	0.3	0.4	0.5	0.65	0.8	1.0

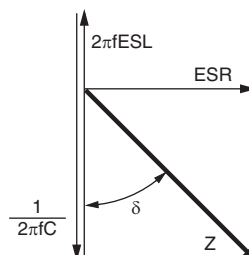

Fig. 12 - Vector diagram showing the AC parameters of a capacitor

RATED RIPPLE CURRENT (I_R)

Any pulsating voltage (or ripple voltage superimposed on DC bias) across a capacitor results in an alternating current through the capacitor.

Because of ohmic and dielectric losses in the capacitor, this alternating current produces an increase of temperature in the capacitor cell.

The heat generation depends on frequency and waveform of the alternating current.

The maximum RMS value of this alternating current, which is permitted to pass through the capacitor during its entire specified useful life (at defined frequency and defined ambient temperature), is called **rated ripple current** (I_R).

The rated ripple current is specified in the relevant detail specifications at 100 Hz or 120 Hz (in special cases at 100 kHz and at upper category temperature).

Usually the rated ripple current will cause a temperature increase of the capacitor's surface of approximately 3 K or 5 K (dependent on series) compared with ambient temperature. A further temperature increase of 3 K or 5 K will be found in the core of the capacitor.

This temperature rise is the result of the balance between heat generated by electric losses:

$$P = I_R^2 \text{ ESR}$$

and the heat carried off by radiation, convection and conduction:

$$P = \Delta T \times A \times \beta$$

I_R can be determined by the equation:

$$I_R = \sqrt{\frac{\Delta T \times A \times \beta}{\text{ESR}}}$$

where:

ΔT = difference of temperature between ambient and case surface (3 K to 5 K, dependent on series)

A = geometric surface area of the capacitor

β = specific heat conductivity, dependent on the size of the capacitor

The heat, generated by ripple current, is an important factor of influence for non-solid aluminum capacitors for calculating the useful life under certain circumstances.

In the detail specifications this factor is considered in the so-called "life-time nomograms" ("Multiplier of useful life" graph) as a ratio between actual ripple current (I_A) and rated ripple current (I_R), drawn on the vertical axis.

Care should be taken to ensure that the actual ripple current remains inside the graph at any time of the entire useful life. If this cannot be realized, it is more appropriate to choose a capacitor with a higher rated voltage or higher capacitance, than originally required by the application.

The internal losses and the resultant ripple current capability of aluminum capacitors are frequency dependent. Therefore, a relevant frequency conversion table ("Multiplier of ripple current as a function of frequency") is stated in the detail specifications. See also "CALCULATION OF USEFUL LIFE BY MEANS OF 'LIFE-TIME NOMOGRAMS'."

CALCULATION OF THE APPLICABLE RMS RIPPLE CURRENT

Non-sinusoidal ripple currents (if not accessible by direct measurement) have to be analyzed into a number of sinusoidal ripple currents by means of Fourier-analysis; the

vectorial sum of the currents thus found may not exceed the applicable ripple current.

For some frequently occurring waveforms, approximation formula are stated in Fig. 13 for calculating the corresponding RMS value.

WAVE FORM	RMS VALUE
	$A \sqrt{\frac{t_0}{T}}$
	$A \sqrt{\frac{t_1 + t_2}{3T}}$
	$A \sqrt{\frac{2t_1 + 3t_2}{3T}}$
	$A \sqrt{\frac{t_0}{2T}}$

Fig. 13 - Approximation formula for RMS values of non-sinusoidal ripple currents

STORAGE

No pre-condition will be necessary for Vishay BCcomponents aluminum capacitors, when stored under standard atmospheric conditions (15 °C to 25 °C; 25 % to 75 % RH; 860 mbar to 1060 mbar) for the following periods of time:

- 1 year for DLC and polymer types
- 2 years for ENYCAP™
- 3 years for non-solid 85 °C types
- 4 years for non-solid 105 °C types
- 10 years for non-solid 125 °C types and 150 °C types
- 20 years for solid types

For non-solid capacitors after these periods, the leakage current for acceptance test shall not exceed twice the specified I_{L5} requirement.

A limited current can be applied to reduce the leakage current of long stored non-solid capacitors to normal values. The maximum allowed current when doing this at room temperature is given by the following formula:

$$I_{\max.} = \frac{\beta \times \pi}{U_r} \times \left(\left(\frac{D}{2} \right)^2 + (D \times L) \right)$$

In this equation, U_r is the rated voltage, D the diameter of the capacitor can and L the length of the capacitor can. When $I_{\max.}$ is in mA, D in mm and L in mm, the value for β is 1 mW/mm². During this reforming process, the rated voltage shall not be exceeded. The process has ended when the current drops below the specified leakage current.

To ensure good solderability and quality of taping, for all types and prior to mounting, the storage time shall not exceed 3 years. This means for example: 2 years storage time between manufacture and arrival at the customer, plus 1 year in customer storage.

OPERATIONAL CONDITIONS

CHARGE-DISCHARGE PROOF

This term means the capability of capacitors to withstand frequent switching operations without significant change of capacitance.

Vishay BCcomponents aluminum capacitors are charge-discharge proof in accordance with “IEC 60384-4” and “EN130300 subclause 4.20”: unless otherwise specified, 10⁶ switching operations (RC = 0.1 s) shall not cause a capacitance change of more than 10 %.

Non-frequent charging and discharging, without a series resistor, will not damage the capacitor.

If a capacitor is charged and discharged continuously several times per minute, the charge and discharge currents have to be considered as ripple currents flowing through the capacitor. The RMS value of these currents should be determined and the resultant value must not exceed the applicable limit.

ENDURANCE TEST

In “IEC 60384-4” or “EN130300” the criteria for the acceptable drift of electrical parameters after the endurance test at U_R and upper category temperature are defined.

Test duration and conditions per series are stated in the relevant detail specification.

The endurance test does not provide information about the useful life of a capacitor, as no failure percentage is defined for this test.

USEFUL LIFE

Useful life (other names: load life, life time or typical life time) is that period of time, during which a given failure percentage may occur, under well defined conditions and

requirements. Useful life data are usually calculated with a confidence level of 60 %.

High quality of materials and controlled manufacturing processes provided, the useful life of non-solid aluminum capacitors is, in most cases, determined by evaporation of electrolyte through the sealing.

Fig. 14 shows the principal electrical consequences of this electrolyte loss: increasing impedance and decreasing capacitance at the end of useful life, for different non-solid types.

Due to the fact that no liquid electrolyte is used in solid aluminum capacitors, the associated failure mechanism does not occur.

For non-solid aluminum capacitors the influence of temperature on useful life is approximated by the so-called “10 K-rule”. The “10 K-rule” states that double the life time can be expected per 10 K temperature decrease; this principle is derived from the well known law of Arrhenius about acceleration of reaction processes.

The exact temperature dependence of useful life for a particular range is given in the corresponding detail specification in the “life-time nomogram” (“Multiplier of useful life” graph in the detail specifications). Detailed performance requirements, on which the definition “useful life” is based, are also stated in the relevant detail specifications.

Exceeding those requirements shall not necessarily induce a malfunction of the equipment involved. The performance requirements offer advice on the choice of components and design of the circuitry.

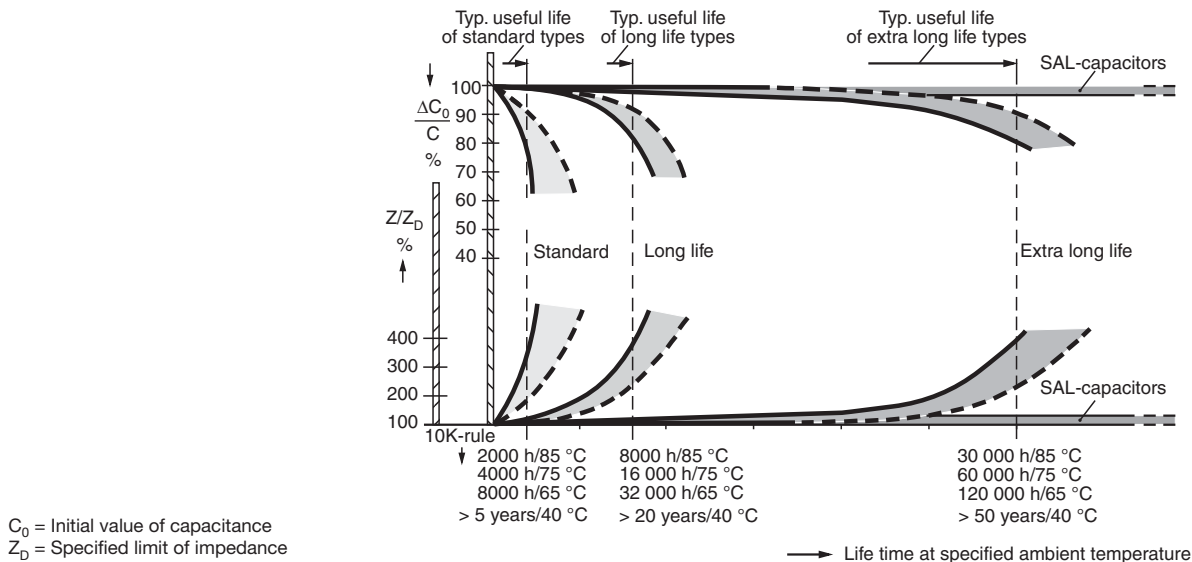

Fig. 14 - Principal trend of electrical parameters during useful life of different aluminum capacitors

CALCULATION OF USEFUL LIFE BY MEANS OF “LIFE-TIME NOMOGRAMS”

Based on the Arrhenius law and on experience for some decades, a nomogram is specified in the detail specification for each range, where the influence of ambient temperature and ripple current on the expected useful life is shown. Ripple currents at other frequencies than specified must be corrected using the frequency conversion tables in the relevant detail specification.

The ratio of actual ripple current to rated ripple current (I_A/I_R) is plotted on the vertical axis and the ambient temperature (T_{amb}) on the horizontal.

At the intersection of these two operational conditions the appropriate multiplier (correction factor) for useful life can be read. The useful life under these operational conditions shall be calculated by multiplying the specified useful life with the correction factor read.

The useful life determined by this procedure is valid for applications without forced cooling. If $I_A/I_R > 1$ and additional cooling is applied, the useful life may be considerably extended.

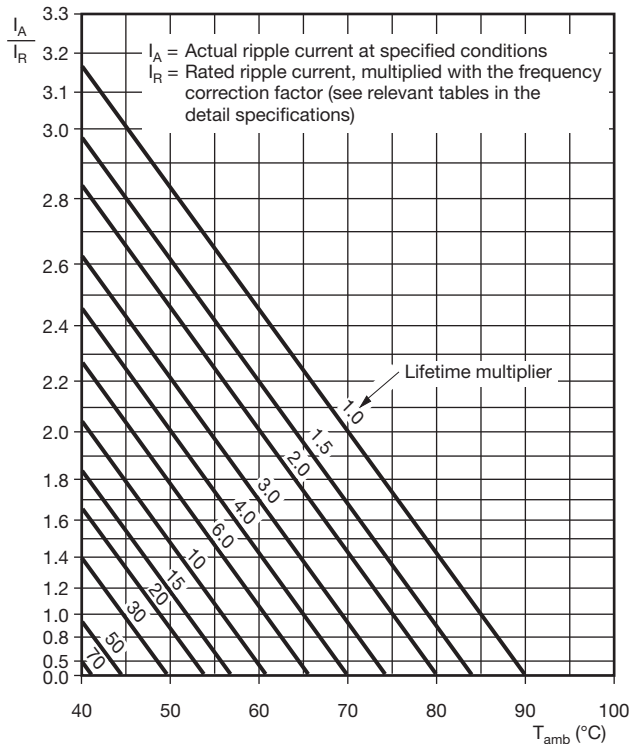

Fig. 15 - Typical example of a life-time nomogram as used for axial and radial 85 °C types: useful life as a function of ambient temperature and ripple current load

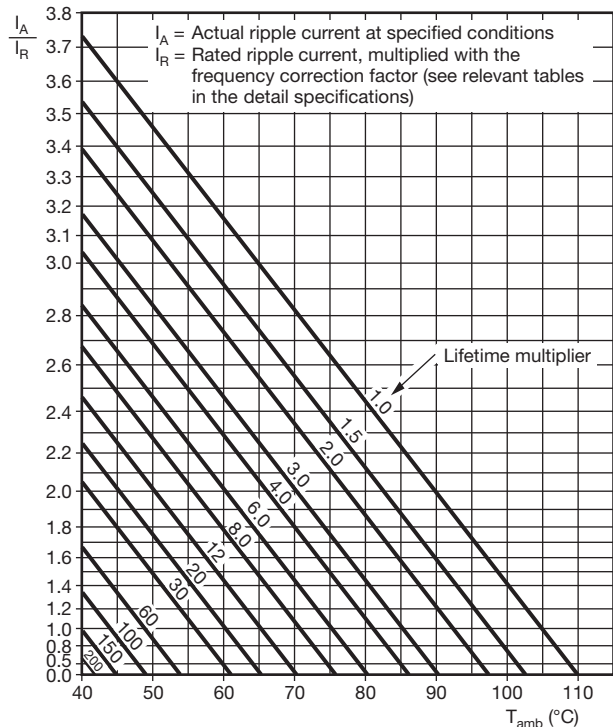

Fig. 16 - Typical example of a life-time nomogram as used for axial and radial 105 °C types: useful life as a function of ambient temperature and ripple current load

EXAMPLES FOR THE USE OF “LIFE-TIME NOMOGRAMS”

Example 1

Temperature in (operating) equipment is 45 °C.

Ripple current load is exactly the rated value (thus: $I_A/I_R = 1$).

Which useful life can be expected (without pause and storage times):

1. For a capacitor with a specified useful life of 2000 h at 85 °C
2. For a capacitor with a specified useful life of 2000 h at 105 °C

Solution:

the corresponding life-time multiplier may be found at the intersection between the vertical “45 °C”-line and the horizontal “1”-line. For the 85 °C type this is “30” (see Fig. 15) and for the 105 °C type it is “90” (see Fig. 16).

Resulting useful life is thus:

1. For 85 °C type: 30 x 2000 h = 60 000 h or about 7 years
2. For 105 °C type: 90 x 2000 h = 180 000 h or about 20 years.



Example 2

Which life time requirement has to be fulfilled by the capacitors, if the equipment life shall be 10 years (approx. 100 000 h), consisting of 1000 h at 75 °C + 9000 h at 65 °C + 90 000 h at 40 °C.

No ripple current applied (thus: $I_A/I_R = 0$).

Solution:

the mentioned life-times shall be converted to specified 85 °C or 105 °C life-times, i.e. they have to be divided through the correction factors found at the intersection of the respective operational conditions (see Table 4).

The required life-time can be fulfilled by types with a specified useful life of:

- 1. > 2970 h at 85 °C i.e. a 3000 h/85 °C type, or
- 2. > 935 h at 105 °C i.e. a 1000 h/105 °C type.

Example 3

Which internal temperature may occur in the equipment, if the actual ripple current at 10 kHz is 3 times higher than specified for a 16 V-type and the load limit may not be exceeded?

Solution:

the ripple current must first be converted from 10 kHz to 100 Hz by using the conversion table (see typical example, Table 3). This shows that the conversion factor for a 16 V-type is 1.2.

$I_A/I_R = 3$ at 10 kHz and must be divided by 1.2, resulting in $I_A/I_R = 2.5$ at 100 Hz.

The load limit is defined by the diagonal line “multiplier 1” in the relevant nomogram.

This means here: the vertical line on the intersection of $I_A/I_R = 2.5$ and the multiplier 1-line shows the maximum permitted internal temperature:

- 1. For 85 °C types this is max. 59 °C
- 2. For 105 °C types this is max. 79 °C

The corresponding life-time in this case is equal to the specified useful life.

Table 3

TYPICAL EXAMPLE OF A FREQUENCY CONVERSION TABLE ⁽¹⁾			
FREQUENCY (Hz)	I _R MULTIPLIER		
	U _R = 6.3 V TO 25 V	U _R = 35 V AND 40 V	U _R = 50 V AND 63 V
50	0.95	0.85	0.80
100	1.00	1.00	1.00
300	1.07	1.20	1.25
1000	1.12	1.30	1.40
3000	1.15	1.35	1.50
≥ 10 000	1.20	1.40	1.60

Note

⁽¹⁾ ($I_{R,t}/I_R$) as a function of frequency; I_R = rated ripple current at 100 Hz

Table 4

LIFE-TIME CALCULATION in “Example 2”		
LIFE CONDITIONS	85 °C TYPES (see Fig. 15)	105 °C TYPES (see Fig. 16)
1000 h at 75 °C	1000/2.9 = 345 h	1000/8 = 125 h
9000 h at 65 °C	9000/6 = 1500 h	9000/20 = 450 h
90 000 h at 40 °C	90 000/80 = 1125 h	90 000/250 = 360 h
	Sum for 85 °C = 2970 h	Sum for 105 °C = 935 h

FAILURE RATE (λ) TOTAL FAILURE PERCENTAGE

Aluminum capacitors, like many other electronic components and devices, exhibit a failure rate which varies with time as depicted in the familiar “bathtub” curve (see Fig. 17). Three distinct regions can be discerned:

- a. Burn-in period, showing a rapidly decreasing failure rate. During production of Vishay BCcomponents’ aluminum capacitors all capacitors undergo a re-forming process which is a short burn-in. All capacitors shipped have passed burn-in.
- b. Constant failure period, showing a low failure rate for a long period. This is the “useful life” period of the aluminum capacitor. The detail specifications of the relevant series specify the upper limit for the total failure percentage (TFP) during this period. For non-solid aluminum capacitors this limit is usually not reached before the wear-out period begins.
- c. Wear-out period, showing an increasing failure rate due to gradual deterioration. For aluminum capacitors with non-solid electrolyte, the onset of this period can be calculated with the nomogram (see Fig. 18).

The failure rate is the number of components failing within a unit of time. For region (b), where the failure rate has a constant value λ , the total failure percentage as a function of time, TFP(t), can be expressed as:

$$TFP(t) = \left\{ 1 - \frac{N(t)}{N(0)} \right\} \times 100 \% = (1 - e^{-\lambda \times t}) \times 100 \%$$

with

$$\lambda = \lambda_{40^\circ\text{C}, 0.5 U_R} \times \text{mult}(T, U/U_R)$$

$N(t)$ is the number of components that have not failed after time t . As λ mainly depends on two stress factors, temperature and the ratio of applied voltage to rated voltage, it is common to normalize it to reference conditions, $T_{\text{amb}} = 40^\circ\text{C}$ and $U = 0.5 \times U_R$. The value for $\lambda_{40^\circ\text{C}, 0.5 U_R}$ is calculated from results of periodical tests in the quality laboratories or derived from field observations.

In order to calculate λ for other operating conditions, the value for the failure rate multiplying factor, $\text{mult}(T, U/U_R)$ in the formula above, must be taken from Fig. 18 (non-solid aluminum capacitors) or Fig. 19 (solid aluminum capacitors).

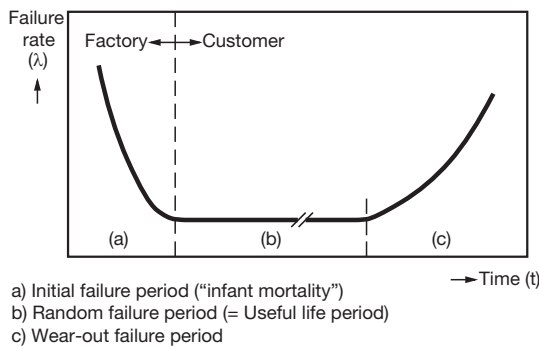

Fig. 17 - Failure rate (λ) as a function of time (“bathtub” curve)

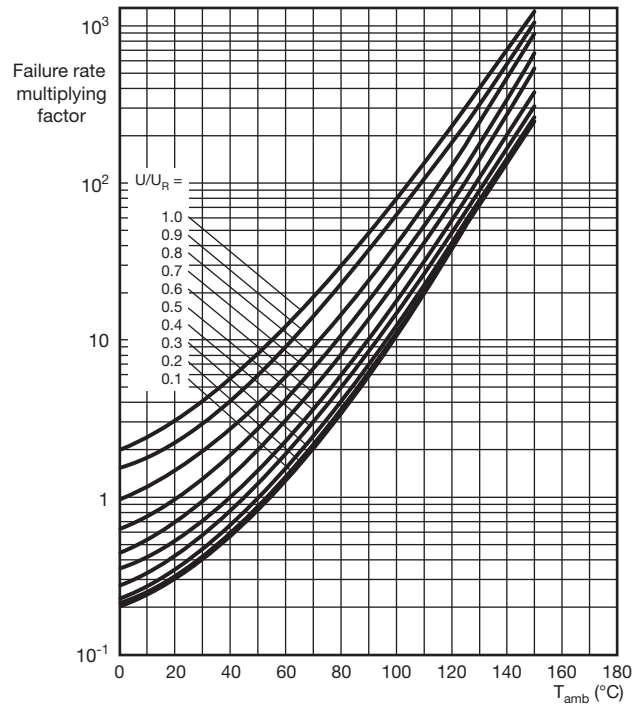

Fig. 18 - Conversion factors for failure rate (λ) as a function of ambient temperature (T_{amb}) and voltage ratio (U/U_R) for non-solid aluminum capacitors

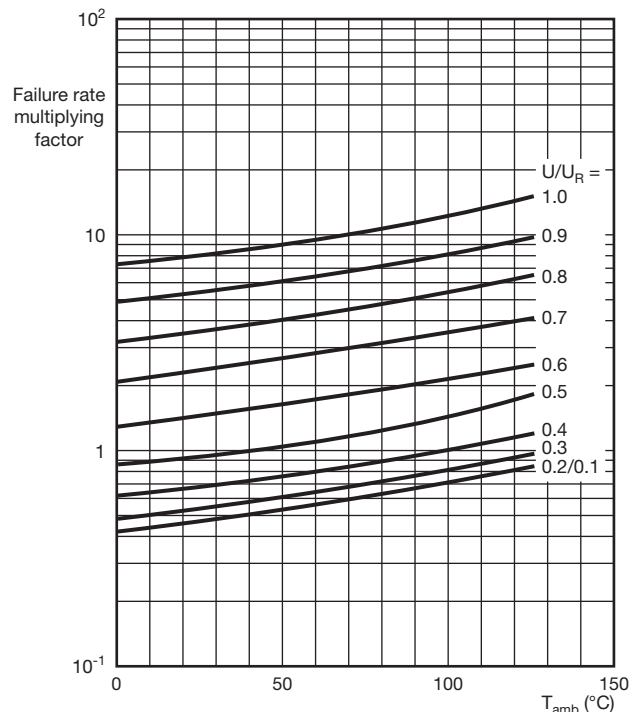

Fig. 19 - Conversion factors for failure rate (λ) as a function of ambient temperature (T_{amb}) and voltage ratio (U/U_R) for solid aluminum capacitors



CLIMATIC CATEGORY

For each capacitor range the climatic category in accordance with "IEC 60068-1" is stated in the relevant detail specification. The climatic category consists of three digit groups; example given in Table 5.

Table 5

Table with 5 columns and 4 rows. Title: EXAMPLE OF CLIMATIC CATEGORIES. Row 1: Example: 40, 085, 56. Row 2: 40, Lower category temperature (here: -40 °C). Row 3: 085, Upper category temperature (here: +85 °C). Row 4: 56, Duration of test "damp heat, steady state" (here: 56 days).

Table 6

Table with 5 columns and 5 rows. Title: MAXIMUM HUMIDITY CONDITION INDICATION FOR THE APPLICATION CLASS. Column 1: CODE LETTER. Column 2: YEARLY AVERAGE. Column 3: 30 DAYS PER YEAR. Column 4: OCCASIONALLY. Column 5: DEWING. Rows C-F show humidity levels and dewing permissions.

APPLICATION CLASS

Although the German standard "DIN 40040" has been withdrawn, it is still widely used in industrial specifications for the definition of climatic working conditions. The application class consists of 3 code letters which have the following meanings.

CODE LETTER MEANINGS

Table with 2 columns and 3 rows. Column 1: Letter position (1st, 2nd, 3rd). Column 2: Meaning (Temperature ranges and humidity conditions).

MOUNTING

MOUNTING POSITION OF NON-SOLID ALUMINUM CAPACITORS

Snap-in and printed wiring (PW) as well as solder lug (SL) aluminum capacitors, in addition to the larger case sizes of axial and radial types, are normally equipped with pressure relief in the aluminum case. These and all smaller case size types, may be mounted in any position.

Screw-terminal aluminum capacitors have a pressure relief in the sealing disc. These types shall be mounted so that no emissions of electrolyte or vapor may reach either the conductors under voltage, or other parts of the printed circuit board. Vertical (pressure relief up) or horizontal (pressure relief on the upper side) mounting position is recommended.

DESIGN RULES FOR "CAPACITOR BATTERIES"

MECHANICAL

Vishay BCcomponents large aluminum capacitors are mainly used in power supply applications under high ripple current load. In these circumstances, the capacitors must be mounted with a distance of ≥ 15 mm from each other, in order to allow sufficient air circulation and to prevent mutual radiation.

Likewise, if axial or radial types are subject to high ripple load, they shall be mounted with sufficient distance (e.g. ≥ 10 mm) from each other for good convection.

ELECTRICAL

Parallel connection

Aluminum capacitors may be connected in parallel, but for safety reasons, large sizes should be individually guarded against sudden energy discharge of the whole battery due to a defective specimen.

Series connection

If two aluminum capacitors are connected in series, balancing resistors are required; see Fig. 20. Without these resistors, leakage current through both capacitors is the same. Because the leakage current for two capacitors can be quite different when the same voltage is applied, forcing the same current through both capacitors will mean that the voltage will not divide evenly. One capacitor might be subjected to a voltage exceeding its rated voltage. Parallel balancing resistors limit the difference in voltage across the capacitors under DC conditions.

For practical purposes the following equation can be used to calculate the maximum possible resistor values in ohms:

$$R = \frac{2 \times U_m - U_{total}}{I_{L5}}$$

Here, U_m is the maximum (rated) voltage that may be present on one of the capacitors and I_{L5} is the specified leakage current in amperes after 5 min (used as an approximation of the difference in leakage current between C1 and C2).

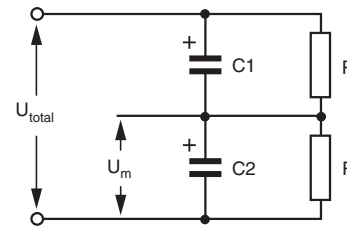

Fig. 20 - Balancing resistors for two aluminum capacitors in series
Combined series / parallel connection

The above mentioned rules for both series and parallel connection are accordingly valid for any combination of these two cases.

MARKING

Vishay BCcomponents aluminum capacitors are identified in accordance with “IEC” rules. When sufficient space is available, capacitors are marked with the following details:

Rated capacitance in μF (the “ μ ” sign represents the position of the decimal point)
 Rated voltage in V

Tolerance on rated capacitance If necessary, as a letter code in accordance with “IEC 60062”, e.g.
 T for -10 % / +50 %
 M for ± 20 %
 K for ± 10 %
 Q for -10 % / +30 %
 A for tolerance according to detail specification

Group number 3-digit part of the catalog number, e.g. 036 for RSP series
 Catalog number or last 8-digits of the catalog number
 Name of manufacturer BCcomponents or BCC or BC

Date code Abbreviation in 2 digits (“IEC 60062”), e.g.

1 st digit		2 nd digit
X = 2009	F = 2015	1 = January
A = 2010	H = 2016	2 = February
B = 2011	J = 2017	...
C = 2012	K = 2018	9 = September
D = 2013	L = 2019	O or A = October
E = 2014	M = 2020	N or B = November
		D or C = December

Example:
 B5 = produced in 2011, May

Production date may also be stated as year / week code.
 Date code may also be stamped in the case.

Factory code Indicating the factory of origin

Polarity identification Strip, band or negative symbol (“-” sign) to indicate the negative terminal and / or a “+” sign to identify the positive terminal.