

Aluminum Electrolytic Capacitor Application Guide

This guide is a full handbook on aluminum electrolytic capacitors, of course with emphasis on Cornell Dubilier's types. It covers construction in depth and discloses the latest information on performance and application for the major aluminum electrolytic types made worldwide. We encourage you to tell us what more you'd like to know, so we can improve this guide.

CONTENTS	PAGE		PAGE
Capacitor Construction	2		
Other Types of Capacitors Comparison	4		
Characterization and Circuit Model	5	TABLES	
Temperature Range	6	Capacitor Parameter Formulas	6
Capacitance	7	Base Lives and Max Core Temperatures	14
Dissipation Factor (DF)	7	Thermal Resistance Screw Terminal Capacitors	17
Equivalent Series Resistance (ESR)	8	Thermal Resistance for Snap-in Capacitors	19
Impedance (Z)	8	Pressure Relief Device Clearance	21
Low-Temperature Impedance	8	Screw Tightening Torque for Screw Terminals	21
DC Leakage Current (DCL)	8	Maximum Currents for Screw Terminals	21
Voltage Withstanding	9	Tightening Torque for Nylon Mounting Nuts	22
Ripple Current	10		
Inductance	10		
Self-Resonant Frequency	10		
Dielectric Absorption	11		
Insulation and Grounding	11		
Elevation & External Pressure	11		
Vibration Withstanding Capability	11		
Safety Considerations	11		
Capacitor Bank Configurations	12		
Non-Polar and Motor Start Capacitors	13		
Reliability and Lifetime	13		
Cooling and Thermal Resistance	16		
Process Considerations	19		
Mounting	20		
Disposal of Capacitors	22		

ALUMINUM ELECTROLYTIC CAPACITOR OVERVIEW

Except for a few surface-mount technology (SMT) aluminum electrolytic capacitor types with solid electrolyte systems, an aluminum electrolytic capacitor consists of a wound capacitor element, impregnated with liquid electrolyte, connected to terminals and sealed in a can. The element is comprised of an anode foil, paper separators saturated with electrolyte and a cathode foil. The foils are high-purity aluminum and are etched with billions of microscopic tunnels to increase the surface area in contact with the electrolyte.

While it may appear that the capacitance is between the two foils, actually the capacitance is between the anode foil and the

electrolyte. The positive plate is the anode foil; the dielectric is the insulating aluminum oxide on the anode foil; the true negative plate is the conductive, liquid electrolyte, and the cathode foil connects to the electrolyte. However, just as the anodic-oxide dielectric insulates the anode foil from the electrolyte, so too the cathode is insulated from the electrolyte by the low voltage air oxide on the cathode foil and the double-layer ionic barrier. This makes the cathode a capacitor in series with the anode. In high voltage capacitors the cathode capacitance is hundreds of times the anode capacitance and does not measurably affect the overall capacitance, but in capacitors of less than about 50 V the anode capacitance begins to approach the value of the cathode capacitance and requires use of higher capacitance cathode to avoid needing to increase the anode length to achieve the rated

capacitance. Aluminum electrolytic capacitor construction delivers colossal capacitance because etching the foils can increase surface area more than 100 times and the aluminum-oxide dielectric is less than a micrometer thick. Thus the resulting capacitor has very large plate area and the plates are intensely close together.

These capacitors routinely offer capacitance values from 0.1 μF to 3 F and voltage ratings from 5 V to 550 V. Up to 700 V are commercially available. They are polar devices, having distinct positive and negative terminals, and are offered in an enormous variety of styles which include molded and can-style SMT devices, axial- and radial-leaded can styles, snap-in terminals styles and large-can, screw-terminal styles. Representative capacitance-voltage combinations include:

330 μF at 100 V and 6,800 μF at 10 V for SMT devices,

100 μF at 450 V, 6,800 μF at 50 V and 10,000 μF at 10 V

for miniature-can styles,

1200 μF at 450 V and 39,000 μF at 50 V for snap-in can styles and

9000 μF at 450 V and 390,000 μF at 50 V for large-can, screw-terminal styles.

If two, same-value, aluminum electrolytic capacitors are connected in series with the positive terminals or the negative terminals connected together, the resulting single capacitor is a non-polar capacitor with half the capacitance. The two capacitors rectify the applied voltage and act as if they had been bypassed by diodes. When voltage is applied, the correct-polarity capacitor gets the full voltage. In non-polar aluminum electrolytic capacitors and motor-start aluminum electrolyte capacitors a second anode foil substitutes for the cathode foil to achieve a non-polar capacitor in a single case.

CAPACITOR CONSTRUCTION

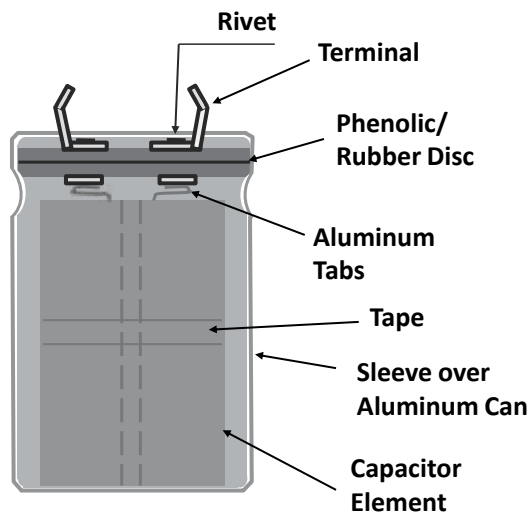

Snap-in Type

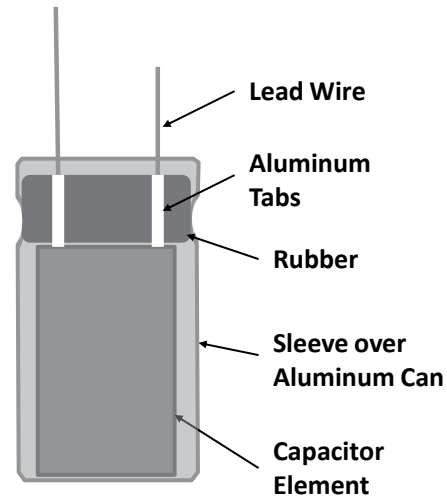

Miniature, Radial-Leaded Type

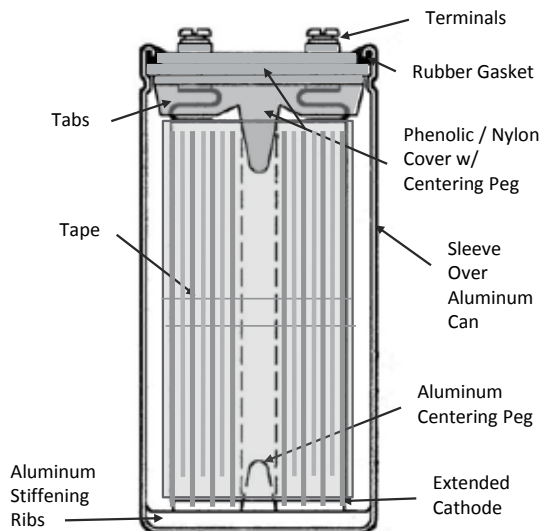

Thermal Pak Construction

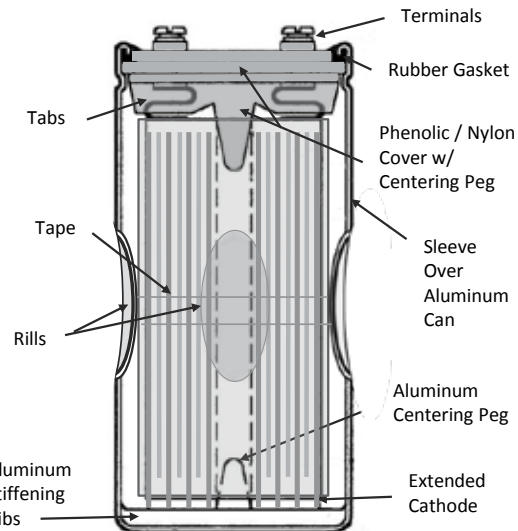

Rilled Construction

These figures show typical constructions of the non-surface-mount aluminum electrolytic capacitors. All Cornell Dubilier capacitors use compression-fit construction so there is no thermoplastic potting compound to interfere with safety-vent operation. Thermal Pak™ and Rilled are Cornell Dubilier's exceptional constructions for screw terminal capacitors. Compared to conventional, potted construction, Thermal Pak operates cooler, provides longer life, withstands higher shock and vibration, delivers more reliable safety vent operation and is lighter weight. Rilled offers superior shock and vibration withstanding, typically withstanding more than 15 g acceleration forces.

ETCHING

The anode and cathode foils are made of high purity, thin aluminum foil, 0.02 to 0.1 mm thick. To increase the plate area and the capacitance, the surface area in contact with the electrolyte is increased by etching the foils to dissolve aluminum and create a dense network of billions of microscopic tunnels penetrating through the foil. For maximum increase in surface area in higher voltage capacitors the anode foil is 99.99% high purity, high cubicity aluminum that allows the billions of microscopic etch tunnels to be parallel and mostly perpendicular to the foil surface.

Etching involves pulling the aluminum foil on rollers through a chloride solution while applying an AC, DC or AC-and-DC voltage between the etch solution and the aluminum foil. Surface area can increase as much as 200 times for foil in low-voltage capacitors and up to 60 times for high-voltage capacitors.

FORMING

The anode foil carries the capacitor's dielectric. The dielectric is a thin layer of aluminum oxide, Al_2O_3 , which is chemically grown on the anode foil during a process called "formation." Formation is accomplished by pulling the anode foil on rollers through an electrolyte bath and continuously applying a DC voltage between the bath and the foil. The voltage is 135% to 200% of the final capacitor's rated voltage. The thickness of the aluminum oxide is about 1.4 to 1.5 nm for each volt of the formation voltage, e.g., the anode foil in a 450 V capacitor may get a formation voltage in excess of 600 V and have an oxide thickness of about 900 nm. That's about a hundredth of the thickness of a human hair.

Formation reduces the effective foil surface area because the microscopic tunnels are partially occluded by the oxide. The tunnel etch pattern is adjusted by choice of foil and etching process so that low-voltage anodes have dense tunnel patterns compatible with thin oxide and high-voltage anodes have coarse tunnel patterns compatible with thick oxide. The cathode foil is not formed and it retains its high surface area and dense etch pattern.

SLITTING

Foil is etched and formed in jumbo rolls of 40 to 50 cm wide and then slit into various widths according to the lengths of the final capacitors.

WINDING

The capacitor element is wound on a winding machine with spindles for one-to-four separator papers, the anode foil, another set of one-to-four separator papers and the cathode foil. These are wound into a cylinder and wrapped with a strip of pressure-sensitive tape to prevent unwinding. The separators prevent the foils from touching and shorting, and the separators later hold the reservoir of electrolyte.

Before or during winding aluminum tabs are attached to the foils for later connection to the capacitor terminals. The best method is by cold-welding of the tabs to the foils with tab locations microprocessor controlled during winding so that the capacitor element's inductance can be less than 2 nH. The older method of attachment is by staking, a process of punching the tab through the foil and folding down the punched metal. Cold welding reduces short-circuit failures and performs better in high-ripple current and discharge applications in which the individual stakes may fail from high current like buttons popping off one at a time from a fat-man's vest.

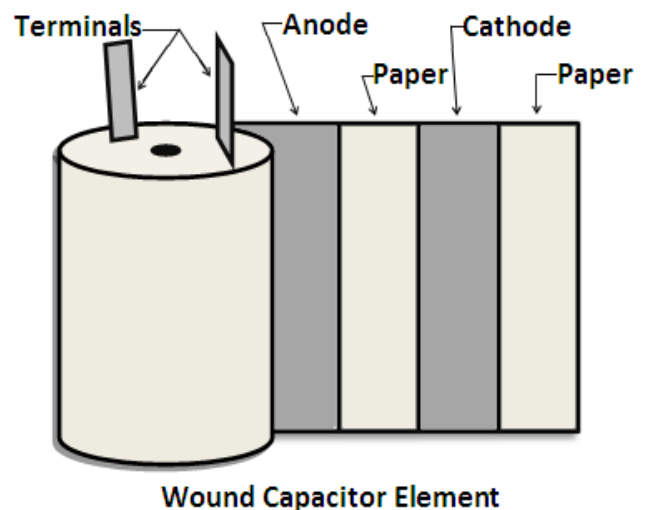

CONNECTING TERMINALS

In SMT capacitors and miniature capacitors with rubber-bungs, extensions of the tabs are the capacitor terminals. But in large-cap capacitors like snap-ins and screw-terminal styles, the tabs are riveted or welded on the underside of the capacitor tops to terminal inserts. Welding produces the lowest contact resistance and highest current handling. Both resistive welding and ultrasonic welding are used. The up to 12 tab pairs that may be used in large screw-terminal capacitors often require more mechanical support during assembly so the tabs in such capacitors may be both riveted to post extensions on the terminals and then welded. In an axial-leaded capacitor the cathode tab is welded to the can before sealing.

IMPREGNATION

The capacitor element is impregnated with electrolyte to saturate the paper separators and penetrate the etch tunnels.

The method of impregnation may involve immersion of the elements and application of vacuum-pressure cycles with or without heat or, in the case of small units, just simple absorption. The electrolyte is a complex blend of ingredients with different formulations according to voltage and operating temperature range. The principal ingredients are a solvent and a conductive salt – a solute – to produce electrical conduction. The common solvent is ethylene glycol (EG) and is typically used for capacitors rated –20 °C or –40 °C. Dimethylformamide (DMF) and gammabutyrolactone (GBL) are often used for capacitors rated –55 °C. Common solutes are ammonium borate and other ammonium salts.

Water in the electrolyte plays a big role. It increases conductivity thereby reducing the capacitor's resistance, but it reduces the boiling point so it interferes with high temperature performance, and it reduces shelf life. A few percent of water is necessary because the electrolyte maintains the integrity of the aluminum oxide dielectric. When leakage current flows, water is broken into hydrogen and oxygen by hydrolysis, and the oxygen is bonded to the anode foil to heal leakage sites by growing more oxide. The hydrogen escapes by passing through the capacitor's rubber seal.

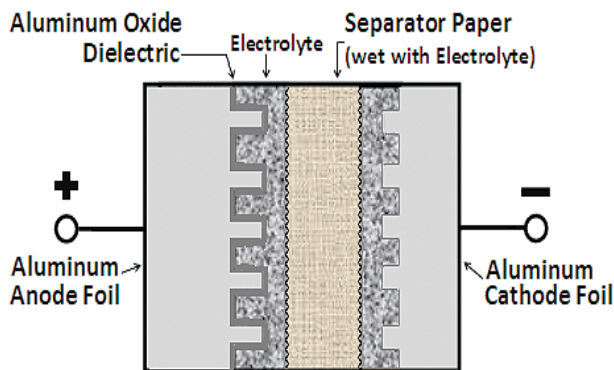

Capacitor-Element Materials

SEALING

The capacitor element is sealed into a can. While most cans are aluminum, phenolic cans are often used for motor-start capacitors. In order to release the hydrogen the seal is not hermetic and it is usually a pressure closure made by rolling the can edge into a rubber gasket, a rubber end-plug or into rubber laminated to a phenolic board. In small capacitors molded phenolic resin or polyphenylene sulfide may replace the rubber. Too tight a seal causes pressure build up, and too loose a seal shortens the life by permitting drying out, loss of electrolyte.

AGING

Here the capacitor assembly comes full circle. The last manufacturing step is "aging" during which a DC voltage greater than the rated voltage but less than the formation voltage is applied to the capacitor. Usually the voltage is applied at the capacitor's rated temperature, but other temperatures and even room temperature may be used. This step reforms the cut edges and any damaged spots on the anode foil and covers any bare aluminum with aluminum oxide dielectric. Aging acts as burn-in and reduces or eliminates early life failures (infant mortals). Low, initial DC leakage current is a sign of effective aging.

COMPARISON TO OTHER TYPES OF CAPACITORS

CERAMIC CAPACITORS

Ceramic capacitors have become the preeminent, general-purpose capacitor, especially in SMT chip devices where their low cost makes them especially attractive. With the emergence of thinner-dielectric, multilayer units with rated voltages of less than 10 V capacitance values in the hundreds of microfarads have become available. This intrudes on the traditional, high-capacitance province of aluminum electrolytic capacitors.

Ceramic capacitors are available in three classes according to dielectric constant and temperature performance. Class 1 (NPO, COG) is suitable for low capacitance, tight tolerance applications in the range of 1 pF to a few mF. Class 2 (X7R, X5R, Y5V) has 20 to 70 times as much capacitance per case size, but capacitance typically varies about ± 10% over its –55 to 125 °C temperature range. The maximum change is +15 % to –25%. Class 3 (Z5U) with about 5 times the capacitance of Class 3 has wild swings of capacitance with voltage and temperature. The temperature range is –25 °C to 85 °C, and capacitance varies about +20% –65% over the range. All classes of ceramic capacitors are available in a variety of physical forms, ranging from round disc or rectangular single layer to multilayer types as well as tubular and feed-through types. Ceramic chip capacitors are brittle and sensitive to thermal shock, so precautions need to be taken to avoid cracking during mounting, especially for high-capacitance large sizes.

The typical temperature range for aluminum electrolytic capacitors is –40 °C to 85 °C or 105 °C. Capacitance varies about +5% –40% over the range with the capacitance loss all at cold temperatures. Capacitors rated –55 °C generally only have –10% to –20% capacitance loss at –40 °C. Cold temperature performance for rated voltages of 300 V and higher is often worse, and temperature performance varies by manufacturer. Thus Class 1 and 2 ceramic capacitors perform better than aluminum electrolytic capacitors at cold temperatures, and Class 3 ceramic capacitors perform worse at all temperatures.

Aluminum electrolytic capacitors readily deliver much more capacitance. Aluminum electrolytic capacitors give more capacitance and energy storage per unit volume than ceramic capacitors for all types except for low-voltage, Class 3 ceramic SMT chip capacitors. While tolerances of ±5% and ±10% are routine for ceramic capacitors, ±20% and –10% +50% are the norms for aluminum electrolytic. This makes aluminum electrolytics the choice for high-capacitance applications like rectification filters and power hold up where more capacitance is a bonus.

Ceramic capacitors are not polarized and therefore can be used in AC applications. The low DF and high capacitance stability of Class 1 and 2 are especially suited to AC and RF applications. By comparison, aluminum electrolytic capacitors are polarized and cannot withstand voltage reversal in excess of 1.5 V. While non-polar aluminum electrolytics are available for momentary-duty

AC applications like motor starting and voltage-reversing applications, the high DF of aluminum electrolytic capacitors – from 2% to 150% – causes excess heating and short life in most AC applications.

Ceramic capacitors are generally no more reliable than aluminum electrolytic capacitors because aluminum electrolytics self heal. Since high-capacitance ceramic capacitors may develop micro-cracks, aluminum electrolytic capacitors are preferred for high capacitance values. However, small sizes of aluminum electrolytic capacitors may have limited life due to dry out, and so consider reliability in your choice for applications operating at high temperatures, over 65 °C.

FILM CAPACITORS

Film capacitors offer tight capacitance tolerances, very low leakage currents and small capacitance change with temperature. They are especially suited to AC applications through their combination of high capacitance and low DF that permits high AC currents. However, they have relatively large sizes and weights.

The popular polymers used for plastic-film dielectric capacitors are polyester and polypropylene. The popular polymer for SMT devices is polyphenylene sulfide (PPS). While film/foil construction is often used for small capacitance values – less than 0.01 µF – and for high-current applications, metallized-film is usually preferred because it gives smaller size, lower cost and is self healing. Film capacitors are general-purpose capacitors for through-hole applications and have special uses for tight-tolerance, AC voltage, high voltage and snubbing.

Polyester film capacitors operate from –55 °C to 85 °C at rated voltage; 85 °C to 125 °C with linear voltage derating to 50% rated voltage. The typical capacitance change over the entire range is less than –5% +15% with ±1% from 0 °C to 50 °C. Capacitance values are readily available up to 10 µF with special large sections to 100 µF. Generally available voltages are 50 to 1000 Vdc and 35 to 600 Vac. AC current handling is limited by polyester's high-temperature DF of about 1%.

Polypropylene film capacitors operate from is –55 °C to 85 °C at rated voltage; 85 °C to 105 °C with linear voltage derating to 50% rated voltage. The typical capacitance change over the entire range is less than +2% –4% with ±1% from –20 °C to 60 °C. Capacitance values are readily available up to 65 µF with special large sections to 1000 µF. Generally available voltages are 100 to 3000 Vdc and 70 to 500 Vac. AC current handling permits use in motor-run and other continuous duty AC applications.

Compared to aluminum electrolytic capacitors, film capacitors take the lead in high voltage, AC voltage and tight tolerance applications. Aluminum electrolytics excel in capacitance and energy storage. However, there is growing use of power film capacitors as replacements for aluminum electrolytic capacitors as dc-link, bus capacitors in high-voltage inverter power systems. While generally power film capacitors are more than four times the price for capacitance as aluminum electrolytic capacitors, film capacitors are perceived as more reliable because failures are relatively benign and without the incidence of explosion and

ignition that can accompany aluminum electrolytic capacitor failures in large high-voltage banks of 10 or more capacitors. Cornell Dubilier now provides special aluminum electrolytic capacitors with improved self-healing to deliver the needed reliability for these applications.

SOLID TANTALUM CAPACITORS

Like aluminum electrolytic capacitors solid tantalum capacitors are polar devices (1 V maximum reverse voltage), having distinct positive and negative terminals and are offered in a variety of styles. Case styles include both molded and conformal-coated versions of radial, axial and surface mount configurations. Typical capacitance values are from 0.1 µF to 1000 µF in voltage ratings from 2 V to 50 V. Typical maximum capacitance-voltage combinations are approximately 22 µF at 50 V for leaded styles and 22 µF at 35 V for surface mount. Strengths are temperature stability, volumetric efficiency and compatibility with all automated assembly systems. Weaknesses are the limited voltage and capacitance ranges and a short-circuit failure mode accompanied by catching fire.

The operating temperature range is –55 °C to 85 °C at rated voltage; +85°C to 125 °C with linear voltage derating to 2/3 rated voltage. The typical capacitance change over the entire range is less than ±5%. Thus aluminum electrolytic capacitors have a much broader voltage and capacitance ranges than solid tantalum capacitors but perform worse at cold temperature.

Solid tantalum capacitors are generally considered more reliable than aluminum electrolytic capacitors because solid tantalum capacitors do not wear out. Their failure rate decreases with time, while aluminum electrolytic capacitors wear out by drying out. As a practical matter, dry-out only affects the smallest capacitors operating in high-temperature environments. Larger aluminum electrolytics do not dry out in the 10 to 20 years expected of most applications, and the open-circuit, dry-out failure is benign compared to solid-tantalum's short circuit failure mode.

PARAMETRIC CHARACTERIZATION

CIRCUIT MODEL

Capacitance occurs when two electrical conductors are separated by an insulator, the dielectric. A capacitor is an electronic component optimized to deliver capacitance. The capacitance in µF is:

$$C = 8.855(10^{-8})(n-1)\epsilon A/d$$

Where n is the number of plates or electrodes, ϵ is the dielectric constant, A is the plate surface area in cm² and d is the thickness of the dielectric between the plates in cm. Dielectric constant is the multiplier increase in capacitance that the dielectric delivers compared to a vacuum. The dielectric constant for aluminum oxide is about 8.

The equivalent circuit on the next page models the aluminum electrolytic capacitor's normal operation as well as overvoltage and reverse-voltage behavior.

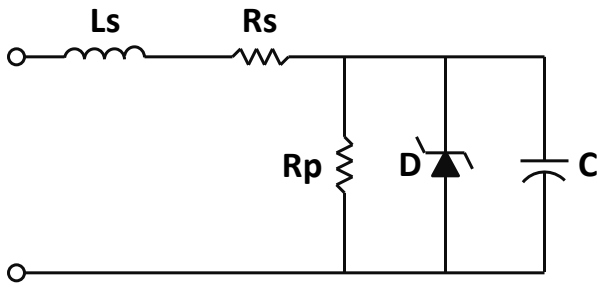

Equivalent Circuit

Capacitance C is the equivalent capacitance and it decreases with increasing frequency. Common values range from 1 μF to 1 F, a six-decade range.

Resistance Rs is the equivalent series resistance, and it decreases with increasing frequency and temperature. It increases with rated voltage. Typical values range from 10 mΩ to 1 Ω, and Rs is inversely proportional to capacitance for a given rated voltage.

Inductance Ls is the equivalent series inductance, and it is relatively independent of both frequency and temperature. Typical values range from 10 nH to 30 nH for radial-leaded types,

20 to 50 nH for screw-terminal types, and up to 200 nH for axial-leaded types. It increases with terminal spacing.

Resistance Rp is the equivalent parallel resistance and accounts for leakage current in the capacitor. It decreases with increasing capacitance, temperature and voltage, and it increases while voltage is applied. Typical values are on the order of 100/C MΩ with C in μF, e.g. a 100 μF capacitor would have an Rp of about 1 MΩ.

Zener diode D models overvoltage and reverse voltage behavior. Application of overvoltage on the order of 50 V beyond the capacitor's surge voltage rating causes high leakage current and a constant-voltage operating mode quite like the reverse conduction of a zener diode. Application of reverse voltage much beyond 1.5 V causes high leakage current quite like the forward conduction of a diode. Neither of these operating modes can be maintained for long because hydrogen gas is produced by the capacitor, and the pressure build up will cause failure.

The table below expresses capacitor parameters for the series equivalent-circuit model shown schematically on the left. From this table Capacitance C, Dissipation Factor DF, Equivalent Series Resistance Rs, Impedance Z, Inductance Ls, Self-Resonant Frequency f_o and Voltage are explored more fully in the next section.

Parameter	Unit	Symbol	Formula	Approximately
Capacitance	farads (F)	C		
Capacitive Reactance	ohms (Ω)	Xc	$1/(2\pi fC)$	Z
Current	amperes (A)	I	$C(dV/dt), Vz/Z$	
Dissipation Factor	none	DF	$Rs/Xc, 2\pi fCRs, \tan(\delta), \cot(\Theta)$	PF
Energy	Joules (J)	E	$\frac{1}{2}CV^2$	
Equivalent Series Resistance	ohms (Ω)	Rs	$DF/(2\pi fC)$	
Frequency	hertz (Hz)	f		
Impedance	ohms (Ω)	Z	$[Rs^2+(Xc-Xl)^2]^{1/2}$	Xc
Inductance	henries (H)	Ls		
Inductive Reactance	ohms (Ω)	Xl	$2\pi fLs$	
Loss Angle	degrees (°)	δ	$\tan^{-1}(DF)$	
Phase Angle	degrees (°)	Θ	$\cot^{-1}(DF)$	
Power	watts (W)	P	I^2Rs	
Power Factor	none	PF	$Rs/Z, \sin(\delta), \cos(\Theta)$	DF
Quality Factor	none	Q	$Xc/Rs, 1/DF, \cot(\delta), \tan(\Theta)$	1/PF
Self-Resonant Frequency	hertz (Hz)	f_o	$1/[2\pi(LC)^{1/2}]$	
Voltage	volts (V)	V	$Vc=IXc, Vz=IZ$	
Volt-Amperes	V-A	VA	IVz, I^2Z	

PARAMETERS

TEMPERATURE RANGE

Operating temperature range

The Operating Temperature Range is the temperature range over which the part will function, when electrified, within the

limits given in the specification. It is the range of ambient temperatures for which the capacitor has been designed to operate continuously. Largely the formation voltage sets the high-temperature limit. Higher formation voltages permit higher operating temperatures but reduce the capacitance. The low-temperature limit is set largely by the cold resistivity of the electrolyte. The higher cold resistivity increases the capacitor's ESR 10 to 100 fold and reduces the available capacitance.

Typical temperature ranges are –20 °C to 55 °C, –25 °C to 85 °C, –40 °C to 85 °C, –55 °C to 85 °C, –40 °C to 105 °C, –55 °C to 105 °C and –55 °C to 125 °C.

Storage Temperature Range

The Storage Temperature Range is the temperature range to which the part can be subjected unbiased, and retain conformance to specified electrical limits. It is the range of ambient temperatures over which the capacitor may be stored without damage for short periods. For long periods of storage keep capacitors at cool room temperatures and in an atmosphere free of halogen gases like chlorine and fluorine that can corrode aluminum. Storage temperature ranges are from –55 °C to the upper limit of the operating-temperature ranges.

CAPACITANCE

Rated Capacitance

The rated capacitance is the nominal capacitance and it is specified at 120 Hz and a temperature of 25 °C. The rated capacitance is also the capacitance marked on the unit.

Capacitance Tolerances

Capacitance tolerance is the permitted minimum and maximum capacitance values expressed as the percentage decrease and increase from the rated capacitance, $\Delta C/C$. Typical capacitance tolerances are $\pm 20\%$, -10% $+50\%$, and -10% $+75\%$. Tighter tolerances are more readily available in high voltage capacitors, e.g., above 150 V, but tolerances tighter than $\pm 10\%$ are generally not available. Note that tighter tolerance parts may meet other tolerance requirements and are readily substitutable.

The capacitance varies with temperature and frequency. This variation itself is also dependent on the rated voltage and capacitor size.

Capacitance Measurement

For aluminum electrolytic capacitors, capacitance is measured as the capacitance of the equivalent series circuit at 25 °C in a measuring bridge supplied by a 120 Hz source free of harmonics with maximum AC signal voltage of 1 Vac and no bias voltage.

Capacitance Temperature Characteristics

The capacitance varies with temperature. This variation itself is dependent to a small extent on the rated voltage and capacitor size. Capacitance increases less than 5% from 25 °C to the high-temperature limit. For devices rated –40 °C capacitance declines up to 20% at –40 °C for low-voltage units and up to 40% for high-voltage units. Most of the decline is between –20 °C and –40 °C. For devices rated –55 °C capacitance typically declines less than 10% at –40 °C and less than 20% at –55 °C.

Capacitance Frequency Characteristics

The effective capacitance decreases as frequency increases. Self-resonance is reached typically below 100 kHz depending on capacitance. At self-resonance the device is resistive and beyond it is inductive. The termination style (i.e., axial, radial, screw-terminal) will influence the inductive characteristics.

Small radial-lead capacitors have inductance of less than 20 nH. Larger capacitors have more inductance according to terminal spacing. See INDUCTANCE.

DISSIPATION FACTOR (DF)

Dissipation factor is the measurement of the tangent of the loss angle ($\tan \delta$) expressed as a percentage. It is also the ratio of the ESR to the capacitive reactance and is thus related to ESR by this equation:

$$DF = 2\pi fC(\text{ESR})/10,000$$

Where DF is a unit-less number expressed in percent, test frequency f is in Hz, capacitance C is in μF and ESR is in Ω .

DF Measurement

The measurement of DF is carried out at +25 °C, 120 Hz, and no voltage bias, with a maximum 1 Vac signal voltage free of harmonics. The value of DF is temperature and frequency dependent.

DF Temperature Characteristics

The dissipation factor decreases with increasing temperature. DF declines about 50% from 25 °C to the high-temperature limit, but increases more than 10 fold at the low-temperature limit. The DF of the better devices rated –55 °C increases less than 5 times at –40 °C.

DF_{lf} , defined in the next paragraph, varies little with temperature and ESR_{hf} , also in the next paragraph, increases 10 to 100 times from 25 °C to the low-temperature limit. The increase in DF at cold temperatures is set by the ESR_{hf} .

DF Frequency Characteristics

The dissipation factor varies with frequency at high frequencies. DF can be modeled as below:

$$DF = DF_{lf} + 2\pi fC(\text{ESR}_{hf})/10,000$$

Where DF is the total dissipation factor in percent, DF_{lf} is the low-frequency dissipation factor in percent, ESR_{hf} is the high-frequency ESR in Ω , f is the test frequency in Hz and C is the capacitance in μF at the test frequency. DF_{lf} results from the power lost by the applied electric field in orienting the molecules of the aluminum oxide dielectric. ESR_{hf} results from the resistive losses in the foils, connections and the electrolyte/separator pad. The electrolyte/separator pad resistance usually dominates and its resistance varies little with frequency. DF_{lf} ranges from about 1.5% to 3%. ESR_{hf} ranges from 0.002 to 10 Ω and decreases with increasing temperature.

The DF equation above shows that DF is constant for low frequencies and crosses over to increasing-DF, constant-ESR, at a crossover frequency inversely proportional to capacitance. Since high-capacitance capacitors have low crossover frequencies, DF increases more with increasing frequency than for lower-capacitance capacitors.

EQUIVALENT SERIES RESISTANCE (ESR)

The equivalent series resistance (ESR) is a single resistance representing all of the ohmic losses of the capacitor and connected in series with the capacitance.

ESR Measurement

For aluminum electrolytic capacitors, ESR is measured as the resistance of the equivalent series circuit at 25 °C in a measuring bridge supplied by a 120 Hz source free of harmonics with maximum AC signal voltage of 1 Vac and no bias voltage.

ESR Temperature Characteristics

The high-frequency ESR declines with increasing temperature. It declines about 35% to 70% from 25 °C to the high-temperature limit, but increases more than 10 fold at the low-temperature limit. The ESR of devices rated -20 °C or -40 °C can increase more than 100 times at -40 °C.

DF_{lf} has a positive temperature coefficient of 0.4 %/°C; so, it varies little with temperature, but ESR_{hf} increases 10 to 100 times from 25 °C to the low-temperature limit. The increase in ESR at cold temperatures is set by the ESR_{hf} .

ESR Frequency Characteristics

Like DF, the ESR varies with frequency. Rewriting the DF equation above, ESR can be modeled as below:

$$ESR = 10,000(DF_{lf})/(2\pi fC) + ESR_{hf}$$

Expressing the ideas in ESR terms, at low frequencies the ESR declines steadily with increasing frequency and crosses over to constant ESR at a frequency inversely proportional to capacitance. This crossover is typically below 10 kHz. The ESR of high-capacitance capacitors changes little with increasing frequency because high-capacitance causes them to have low crossover frequencies. The ESR_{hf} ranges from 0.002 Ω for large, screw-terminal capacitors to 10 Ω for miniature devices.

IMPEDANCE (Z)

For aluminum electrolytic capacitors impedance is actually impedance magnitude. It is the ratio of voltage to current at a given frequency and is related to the capacitor's capacitance, ESR and series inductance as follows:

$$Z = [(ESR)^2 + (1/(2\pi fC) - 2\pi fL_s)^2]^{1/2}$$

Where Z is impedance in Ω, ESR is equivalent series resistance in Ω, f is frequency in Hz, C is capacitance in F and L_s is equivalent series inductance in H.

Z Measurement

For aluminum electrolytic capacitors, Z is measured as the impedance magnitude of the equivalent series circuit at 25 °C in a measuring bridge supplied by a variable frequency source capable of delivering an AC signal voltage of 1 Vac free of harmonics from 10 Hz to 100 kHz. Impedance measurements are mostly for typical performance curves and for low-temperature limit measurements.

Low-Temperature Impedance

Low-temperature impedance is the capacitor's 120 Hz impedance measured at the low-temperature limit. It is usually expressed as a multiple of the device's 25 °C impedance.

Z Low-Temperature Measurement

For low-temperature impedance measurement, place the capacitors in a chamber set to the low-temperature limit ± 2 °C. Measure impedance at 120 ± 5 Hz using any suitable method providing an accuracy of $\pm 2\frac{1}{2}$ %. After temperature stabilization, make the measurements quickly using as small as practical an AC measuring voltage in order that it will not cause heating of the capacitors. Assure that the capacitors have reached thermal stability by demonstrating that two successive measurements taken at 15 minute intervals show no change.

Z Temperature Characteristics

Impedance typically decreases less than 5% from 25 °C to the high-temperature limit but increases up to 10 times to the low-temperature limit.

Z Frequency Characteristics

The frequency characteristics of impedance are dictated by the contributions from capacitive reactance ($1/(2\pi fC)$), inductive reactance ($2\pi fL$) and from resistive losses in the electrolyte. A typical impedance-versus-frequency curve is below. The low point is at the self-resonant frequency, and the impedance is equal to the ESR at that frequency.

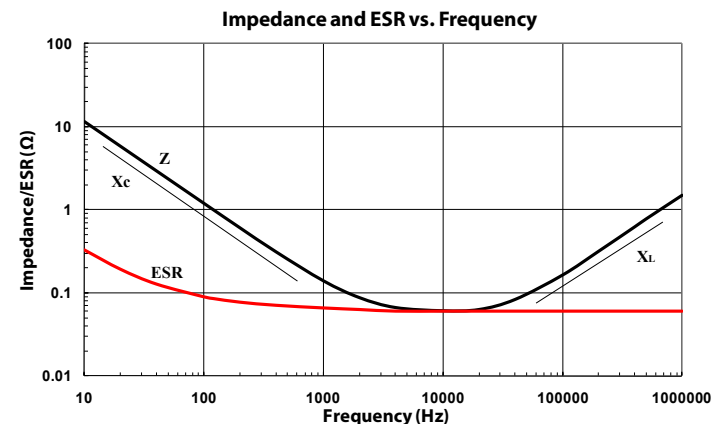

DC LEAKAGE CURRENT (DCL)

DC Leakage Current is the DC current flowing through the capacitor with the rated voltage applied. The value of leakage current depends on the voltage applied, the charging period and capacitor temperature.

DCL Method of Measurement

Measure leakage current at 25 °C with the rated voltage applied through a protective resistance of 1000 Ω in series with the capacitor in the measuring circuit. Five minutes after the

application of voltage, the leakage current is not to exceed the maximum value indicated in the specification.

DCL Temperature Characteristics

Typical temperature characteristics are shown below:

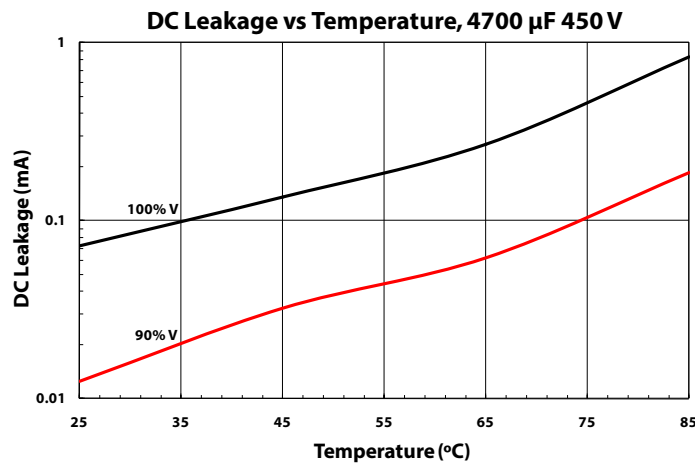
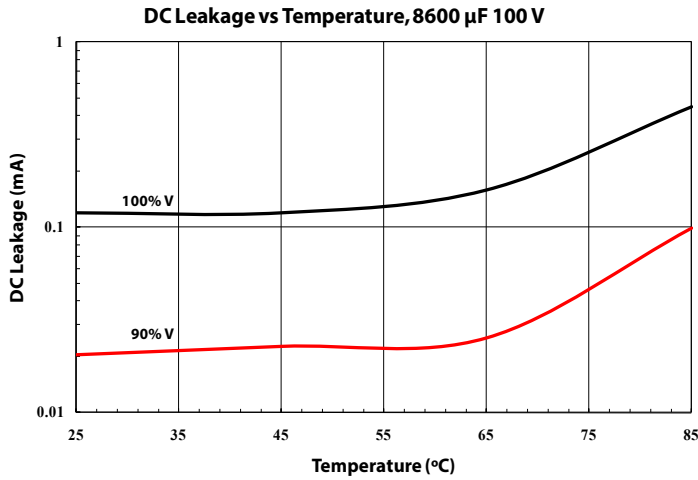

DCL Voltage Characteristics

The leakage current value drops rapidly as the applied voltage decreases below the capacitor's rated voltage. The effect of voltage derating on the leakage current is shown next.

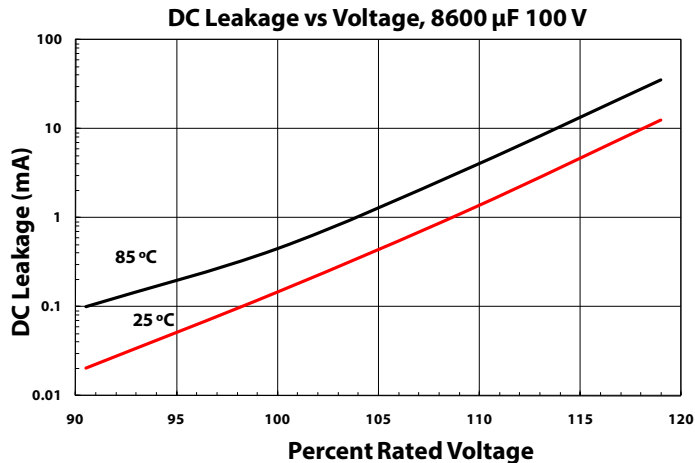

DC Leakage vs Voltage, 4700 µF 450 V

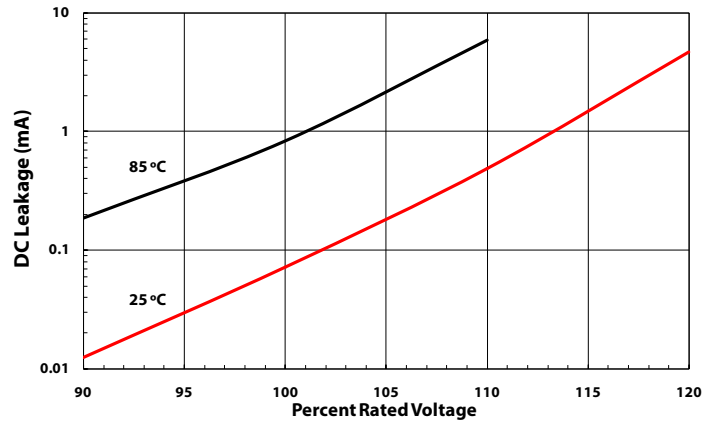

VOLTAGE WITHSTANDING

Rated DC Voltage

Rated DC voltage is the nominal voltage marked on the capacitor, and it is the maximum peak voltage including ripple voltage that may be applied continuously between the terminals and over the rated temperature range. Higher rated voltage capacitors may be substituted for lower rated voltage capacitors as long as case size, DF, and ESR ratings are also compatible.

Rated Surge Voltage

Rated surge voltage is the maximum DC overvoltage to which the capacitor may be subjected at 25 °C for short periods not exceeding approximately 30 s at infrequent intervals of not less than 5 min.

Surge voltage Measurement

Subject the capacitors to their rated surge voltage at normal room temperature and through a 1000 Ω ±10% resistor (except for capacitances of 2500 µF and up, use a higher value resistor calculated as 2,500,000/C Ω ±10% where C is the capacitance in µF). Cycle the voltage ½ minute on followed by 4½ minutes off during which each capacitor is discharged through the charging resistor or equal resistor. Repeat the cycles for 120 h. Post test requirements are for DCL, ESR and DF to meet initial requirements and for there to be no evidence of mechanical damage or electrolyte leakage. Electrolyte residue with no droplets or visible flow is permitted.

Reverse Voltage

Aluminum electrolytic capacitors are polarized and must be connected in the correct polarity. They can withstand reverse voltages up to 1.5 V. Higher reverse voltage can cause failure by pressure build up and rupture of the capacitor's safety vent structure. Non-polar and semi-polar devices are available that can withstand reverse voltage.

Transient Overvoltage

Aluminum electrolytic capacitors can generally withstand extreme overvoltage transients of limited energy. Application of overvoltage more than about 50 V beyond the capacitor's surge voltage rating causes high leakage current and a constant-voltage operating mode quite like the reverse conduction of

a zener diode. The capacitor may fail short if the electrolyte cannot take the voltage stress, but even if it can, this operating mode cannot be maintained for long because hydrogen gas is produced by the capacitor, and the pressure build up will cause failure. However, special designs are available that use the overvoltage, zener-clamping effect to successfully protect equipment from overvoltage transients such as lightning strikes.

Capacitors used as bus capacitors in large, high-voltage capacitor banks are less capable of withstanding overvoltage transients because the high energy and low source impedance of the capacitor bank can prevent a momentary partial discharge from self healing and cause it to become a runaway short-circuit failure. For high-voltage capacitor-bank applications use capacitors proven for that use.

RIPPLE CURRENT

Ripple current is the AC current flowing in the capacitor. It's called ripple current because the associated AC voltage rides like ripple on water on the capacitor's DC bias voltage. The ripple current heats the capacitor and the maximum permitted ripple current is set by how much can be permitted and still meet the capacitor's load life specification. Too much temperature rise will cause the capacitor to exceed its maximum permitted core temperature and fail quickly, but operation close to the maximum permitted core temperature dramatically shortens expected life. The load life specifications for aluminum electrolytic capacitors operating at maximum permitted core temperature are typically 1000 to 10000 hours. That's a load life of six weeks to a year and a seventh and not long enough time for most applications.

Ripple current ratings usually assume that the capacitor is convection cooled and that the entire can is in contact with air. A convection coefficient of $0.006 \text{ W}/^\circ\text{C}/\text{in}^2$ predicts the temperature rise from air to the case, and the core temperature is assumed to be the same as the case temperature. The power dissipated is the ripple current squared times the ESR. Often the 25°C , 120 Hz maximum ESR is used, but since ESR decreases at elevated temperatures, less than maximum ESR may be used to calculate power dissipated.

Here's an example. Suppose you wanted the ripple-current rating for a $4700 \mu\text{F}$, 450 V capacitor in a 3 inch (76 mm) diameter and $5 \frac{5}{8}$ inches (143 mm) long can and the maximum ESR at 25°C and 120 Hz is $30 \text{ m}\Omega$. The can area – not including the terminal end – is 60.1 in^2 (388 cm^2). The thermal conductance is $(0.006)(60.1) = 0.36 \text{ W}/^\circ\text{C}$. For a 10°C temperature rise the case may dissipate 3.6 W . So the permitted ripple current with an ESR of $30 \text{ m}\Omega$ is 11 A. If you assume that the ESR would decrease 35% by 85°C , then the maximum ripple current can be 13.6 A.

With large-can capacitors, like the one in this example, neglecting the temperature rise from the case to the core can seriously overstate the ripple current capability. With some constructions the core is 3 to 5°C per watt of ripple power hotter than the case. So the total temperature rise would be more than double the intended 10°C with rated ripple current and maximum ESR. It is generally safe to assume that the core temperature is the same as the case temperature for capacitors smaller than 25 mm

diameter. For larger cases with high ripple current, verify the temperature rise by requesting samples with thermocouples imbedded in the cores.

Cornell Dubilier Thermal Pak, screw-terminal capacitors have controlled, low thermal resistance from core to case. You can predict temperature rise using the **Thermal Resistance Chart** later in this section or by using the thermal-resistance/expected-life model available on the website, <http://www.cde.com>.

Ripple Current Temperature Characteristics

Rated ripple current can be increased for operating temperatures less than rated temperature. Multipliers are shown in the specifications. Generally the multipliers are derived based on maximum core temperature (T_c), rated temperature (T_r) and ambient temperature (T_a) as

$$\text{Ripple Temperature Multiplier} = [(T_c - T_a)/(T_c - T_r)]^{1/2}$$

Counting on multipliers for temperatures below 60°C and for more than $1\frac{1}{2}$ times rated ripple current is risky. High ripple currents can cause shorter operating lives than expected because as the capacitor ages its ESR increases and causes more heating for the same ripple current. This accelerates wearout.

Ripple Current Frequency Characteristics

Rated ripple current can be adjusted for operation at frequencies other than 120 Hz. Multipliers are shown in the specifications. Generally the multipliers are derived based on expected ESR change with frequency; however, as discussed above, ESR is a complex function of temperature, capacitance and rated voltage as well as frequency. So it is difficult to create ripple-frequency multiplier tables that accurately model the frequency dependence. For high-ripple current applications verify ESR at frequencies of interest and calculate total power dissipated.

INDUCTANCE

Inductance is the equivalent series inductance, and it is relatively independent of both frequency and temperature. Typical values range from 2 to 8 nH for SMT types, 10 nH to 30 nH for radial-leaded types, 20 to 50 nH for screw-terminal types, and up to 200 nH for axial-leaded types. These low values are achieved by tab location and the intrinsic, low inductance of the dielectric contact geometry. The capacitor element has typical inductance of less than 2 nH.

SELF RESONANT FREQUENCY

The self-resonant frequency is the frequency at which the capacitive reactance ($1/(2\pi fC)$) equals the inductive reactance ($2\pi fL$). Because the capacitive reactance is 180 degrees out of phase with the inductive reactance, the two reactances subtract out, and the remaining impedance is purely resistive and is equal to the ESR at that frequency. Above self resonance the device is inductive. In aluminum electrolytic capacitors the self-resonant frequency typically occurs at less than 100 kHz. The self-resonant frequency is equal to $1/[2\pi(LC)]^{1/2}$. It occurs at a frequency higher than expected based on 120 Hz capacitance because capacitance decreases with increasing frequency.

The self resonant frequency can decrease with increasing temperature from capacitance increase.

DIELECTRIC ABSORPTION

Dielectric absorption may be observed as the reappearance of a voltage across a capacitor after the terminals have been shorted for a brief period and the short removed. This characteristic is important in RC timing circuits, triggering systems and phase shift networks. For aluminum electrolytic capacitors dielectric absorption will allow up to 10% recovery of the charging voltage between 100 s and 1000 s at 25 °C, and is more pronounced at higher temperatures. Maximum dielectric absorption can be obtained by charging capacitors for 1 hour at rated voltage and discharging through a dead short for 1 minute. Subsequent measurements over time can be made with a high impedance micrometer.

With high-voltage aluminum electrolytic capacitors rebound voltages of 40 to 50 V are possible. While such voltages are not a safety hazard, they can certainly cause sparking and create a frightening distraction if the terminals are shorted by a tool during installation. Conductive tape and wire shorting straps can be supplied for the faint of heart. The tradeoff is extra cost and the labor to remove them.

INSULATION AND GROUNDING

With non-solid electrolyte aluminum electrolytic capacitors the aluminum cases connect to the negative terminals by contact with electrolyte. The resulting isolation resistance may vary from a few ohms to a few thousand ohms. For axial leaded capacitors and flatpacks the case is connected to the negative lead. If objects contacting the cases are to be at a potential other than the negative terminal's potential, use capacitors with insulating sleeves.

The plastic insulation can withstand 3000 Vdc or 2500 Vac, 60 Hz for 1 minute applied between the case and a ¼ inch wide metal foil placed around the sleeve. For stud-mounting, apply the voltage between the mounting plate and the case, and mount the capacitor with an approved nylon nut and clearance hole.

Insulation resistance is no less than 100 MΩ after 2 minutes electrification with 100 volts applied between the foil and the capacitor case.

ELEVATION AND EXTERNAL PRESSURE

Not relevant for capacitors with solid electrolyte. Aluminum electrolytic capacitors can operate to 80,000 feet and pressures as low as 3 kPa. Maximum air pressure depends on the size and style of the capacitor. Exceeding the maximum value can damage the capacitor by crushing the case, opening the pressure-relief vent or causing a short circuit.

VIBRATION WITHSTANDING CAPABILITY

Aluminum electrolytic capacitors can generally withstand 10 g vibration forces. Limits are shown in the specifications. Adjust the procedure below as required by the individual type specifications.

To test vibration resistance, clamp the capacitors to a vibrating platform and subject them to a simple harmonic motion having maximum peak-to-peak amplitude of 0.06 inches and maximum acceleration of 10 g or 15 g as specified. Vary the frequency of vibration linearly between 10 and 55 Hz. Traverse the entire frequency range in 1 minute. Unless specified otherwise, vibrate the capacitors for 1½ hours with the direction of motion being parallel to the axis of the capacitor, then place the capacitors so that the direction of motion is perpendicular to the axis and continue vibration for 1½ hours. During the last ½ hour of test connect the capacitor to a capacitance meter and observe for a 3-minute period.

There will be no evidence of loosening of the capacitor element within the container when shaken by hand following the test. Also there will be no indication of intermittent contact, open or shorting during the 3-minute observation period.

SAFETY CONSIDERATIONS

Pressure-Relief Vent

During operation of an aluminum electrolytic capacitor with non-solid electrolyte, gas pressure normally increases. This gas is mostly hydrogen and excess pressure is avoided by permeation of the gas through the capacitor's seal. But in cases like application of overvoltage, reverse voltage, AC voltage or capacitor failure, excess pressure can cause the capacitor to explode. To reduce the risk of explosion aluminum electrolytic capacitors are usually equipped with pressure-relief vent structures. These safety vents are intended to rupture and release the gas pressure. After rupture the capacitor has limited life because it loses electrolyte and dries out.

Be careful not to interfere with the operation of the vent, for instance by mounting measures such as clamps, glue or potting compounds. In the case of large capacitors with the capacitor elements secured by thermoplastic potting, don't mount them with the safety vents down as the potting may flow when the capacitors overheat and block the vents.

In rare cases for capacitors mounted alone and more often for capacitors in multiple-unit parallel capacitor banks a fully functioning pressure relief device may not react in time. This could be from extreme overload or ignition of gas inside the capacitor through sparking caused by breakdown. Protect personnel from possible rupture of high-energy capacitors with shielding, and be sure to use substantial shielding when testing the pressure-relief vent. Examples of appropriate shielding for testing are ¼-inch thick steel or ½-inch polycarbonate enclosures with one end open to redirect the explosion rather than contain it.

Test the capacitor's pressure-relief capability by applying voltage or current using one of the following three methods:

A. Subject the capacitor to AC current according to the rated capacitance as below:

Rated Capacitance μF	Test Current Aac, 60 Hz
up to 3000	1 to 100
3,000 to 20,000	85 to 150
above 20,000	100 to 175

B. For a capacitor rated 150Vdc and above, apply 110 to 125 Vac, 60 Hz through a $5\ \Omega \pm 10\%$ series, current-limiting resistor.

C. Subject the capacitor to reverse polarity, DC voltage sufficient to allow a current from 1 to 10 A to flow.

The excess internal pressure will be relieved without violent expulsion of the capacitor element or cover or ignition of surrounding material. To demonstrate non-ignition, wrap the case loosely with two layers of cheese cloth which must not ignite during test. A short or open circuit is not a failure of the test.

Contact with Electrolyte

The electrolyte in non-solid electrolytic capacitors is a biodegradable liquid based on a stable solvent with a high boiling point as the main ingredient. The most common solvent is ethylene glycol (EG). Dimethylformamide (DMF) and gammabutyrolactone (GBL) may be used in capacitors rated $-55\ ^\circ\text{C}$. The electrolyte includes an acid base system and other chemicals. The electrolyte is chemically neutral and contains no PCBs or halogenated compounds. It has low toxicity but you should avoid contact with the skin or eyes and avoid prolonged inhalation. A Material Safety Data Sheet is available for the electrolyte solvent base material.

Immediately treat contact with electrolyte by rinsing exposed area with water. If electrolyte contacts eyes, flush for 10 minutes with running water. Seek medical attention if any symptoms persist. Avoid inhalation of electrolyte vapors or dust particles. If vapors are present, ventilate the room. Smoke from burning electrolyte is irritating but does not contain dioxins or similar toxic substances. If electrolyte gets on clothing, wash it off with water.

Charge-Discharge

Frequent, rapid charge and discharge of aluminum electrolytic capacitors not designed for such service can damage the capacitors by overheating and overpressure or breakdown with consequent failure by open or short circuit. For charge-discharge applications use capacitors designed for that use.

Polarity – Reverse Voltage

Check the polarity of each capacitor both in circuit design and in mounting. Polarity is marked on the capacitor. While the capacitors can withstand continuous application of 1.5 V reverse voltage, exceeding that can damage the capacitor by

overheating, overpressure, and dielectric breakdown. This can result in associated open-circuit or short-circuit failures and rupture of the capacitor's pressure-relief vent.

Flammability

Aluminum electrolytic capacitors contain materials which can catch fire and support combustion when contacted by flames. Flammable parts include plastic parts, insulating sleeves, paper, and the electrolytes. Most capacitors will pass the needle-flame test requirements of UL 94V-O and not support combustion to the requirements of Category B or C.

In rare cases the capacitor may self-ignite from heavy overload or capacitor defect. Hydrogen in the capacitor can ignite if sparking occurs during capacitor failure. In critical applications such as mining applications consider providing fire-resistant shields.

CAPACITOR BANK CONFIGURATIONS

PARALLEL

Capacitors may be connected in parallel for increased capacitance and ripple-current capability.

Bus Structure

When connecting capacitors in parallel, design the connecting bus with these features in mind. For minimum series inductance use a laminated-bus or strip-line structure. For example, have one plane of the circuit board as the plus connection and another plane as the minus connection to all capacitors. Path resistance to each capacitor should be equal to assure equal current sharing. While ripple current divides among the capacitors in proportion to capacitance values for low-frequency ripple, high-frequency ripple current divides in inverse proportion to ESR values and path resistance.

Fusing

In order to fuse the individual capacitors, include a slow-start circuit at equipment turn-on, and fuse each capacitor at twice its expected, maximum ripple current. The slow-start circuit can be a resistor in series with the capacitors that is shorted after initial charging.

SERIES

Capacitors may be connected in series for increased voltage withstanding.

Voltage Sharing

During charging the voltage on each capacitor connected in series is proportional to the inverse of the actual capacitance, but upon reaching final voltage, the voltage on each capacitor is proportional to the inverse of the capacitor's leakage current. Of course in a series string there is only one leakage current and the capacitors with a propensity for higher leakage current will get less voltage. Since leakage current increases with applied voltage, less voltage results in higher leakage resistance, and the voltages tend to equalize. However, voltage distribution will not be uniform, and to assure that no capacitor is subjected to more

than its rated voltage, use higher rated voltage capacitors or a balancing scheme such as balancing resistors, discussed next. Assist voltage sharing stability by using capacitors from the same manufacturing lot and mounting them to operate at the same temperature.

Balancing Resistors

The difference in leakage currents in μA for two capacitors in series at rated temperature can be estimated as $0.0015CV_b$ where C in μF is rated capacitance of each capacitor and V_b in V_{dc} is the bus voltage across the two series capacitors. Using this estimation enables selecting a value of balancing resistance for each capacitor as follows:

$$R = (2V_m - V_b) / (0.0015CV_b)$$

Where R in $M\Omega$ is the balancing resistance, V_m is the maximum voltage you'll permit on either capacitor, and V_b is the maximum bus voltage across the two capacitors.

For three or more capacitors in series use the following where n is the number of capacitors in series:

$$R = (nV_m - V_b) / (0.0015CV_b)$$

PARALLEL/SERIES

Capacitors connected as shown below with a common connection between multiple series combinations have these considerations.

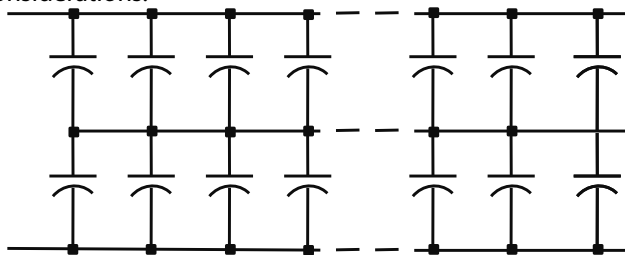

Parallel-series array with common center connection

Advantages: As the number of capacitors in parallel increases the capacitance at the top tends to equal the capacitance at the bottom. This improves voltage balance during transients. Also the leakage current at the top tends to equal the leakage current at the bottom, so voltage balance improves during steady-state conditions. Finally, only two balancing resistors need be considered, and the top and bottom may be so well matched as to eliminate the need for balancing resistors.

Disadvantage: If one capacitor fails short, the other half of the bank gets the entire bus voltage, so other capacitors will fail too unless the shorted capacitor blows open. Thus one capacitor failure can cause failure of the entire bank.

SERIES/PARALLEL

Capacitors connected as shown below with multiple series combinations in parallel have these considerations. This configuration is the clear choice when balancing resistors are not used.

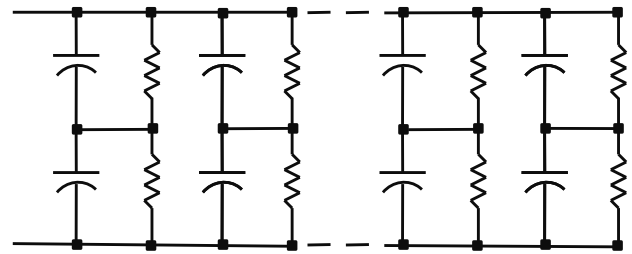

Series - parallel array, no center connection

Advantages: If one capacitor fails short then the capacitor in series with it also fails, but other capacitors in the bank are unaffected. If balancing resistors are not used, high leakage current of one capacitor affects only a single pair of capacitors. The independent, series pairs permit fusing.

Disadvantages: With balancing resistors the construction is more complex; many resistors need to be fitted, and the additional resistors cost more.

NON-POLAR AND MOTOR START CAPACITORS

If two, same-value, aluminum electrolytic capacitors are connected in series with the positive terminals or the negative terminals connected together, the resulting single capacitor is a non-polar capacitor equal in capacitance to half of the rated capacitance of either of the original pair. The two capacitors rectify the applied voltage and act as if they had been partially bypassed by diodes. However, at all levels of AC voltage the apparent capacitance is half of the rated capacitance as you would expect for capacitors connected in series. The nonlinear performance produces distortion where non-polar aluminum electrolytic capacitors are used in audio AC applications.

In non-polar aluminum electrolytic capacitors and motor-start aluminum electrolytic capacitors a second anode foil substitutes for the cathode foil to achieve a non-polar capacitor in a single case. These are available for momentary-duty AC applications like motor starting and voltage-reversing applications, but the high DF of aluminum electrolytic capacitors – from 2% to 150% – causes excess heating and short life in most AC applications.

Aluminum electrolytic, motor-start capacitors are non-polar and designed for intermittent operation in starting single-phase induction motors or for other brief AC applications such as motor-run capacitors in electric door openers.

RELIABILITY AND LIFETIME

Aluminum electrolytic capacitors are quite reliable largely because of their effective, self-healing mechanism. While wear-out is the most common failure mode, most such failures are gradual conversions to open circuits as the units become more and more resistive.

Failure Modes

Early-Life Failures

Early-life failures, infant mortals are mostly short-circuit failures from weaknesses in the aluminum oxide dielectric. Incidence can be reduced with extended aging or burn-in.

Random Failure Rate

The following formula accurately fits failure rates for Cornell Dubilier aluminum electrolytic capacitors reported on billions of unit hours of field life data in large volume applications with multiple levels of voltage and temperature stress.

$$\lambda = 4000,000N_a^3 C^{1/2} 2^{(T_a - T_m)/10} (L_b V_r^2)$$

λ = random failure rate in FIT

N = number of capacitors in the array

V_a = applied voltage in Vdc

C = capacitance of one capacitor in F

T_a = actual core temperature in °C

T_m = maximum permitted core temperature in °C

L_b = base life in hours at T_m and V_r

V_r = rated voltage in Vdc

Wear-Out

Wear-out failures are mostly open-circuit failures from loss of electrolyte or ESR increase from other causes. In the case of large capacitors enduring high levels of ripple current, the increasing ESR can cause overheating and short-circuit failures as wear-out failures.

Operating Life

Onset of wear-out is determined mainly by the capacitor's size and average operating temperature. Operating voltage has some effect. For capacitors operating at moderate temperatures the operating life doubles for each 10 °C that operating temperature is reduced. Operating life can be expressed as

$$L_{op} = MvL_b 2^{((T_m - T_a)/10)}$$

Where

L_{op} is the expected operating life in h,

Mv is a unitless voltage multiplier for voltage derating, L_b is the expected operating life in h for full rated voltage and temperature,

T_m is the maximum permitted internal operating temperature in °C, and

T_a is the actual capacitor internal operating temperature in °C.

Most manufacturers use this model to predict operating life; however, values for Mv , L_b and T_m vary both by capacitor type and by manufacturer. For case diameters larger than 25 mm with significant ripple current, take into account the temperature rise of the capacitor element over its case.

Some makers appear to calculate operating life saying that expected lifetime doubles with less than a 10 °C drop in temperature. The expectation that life doubles for each 10 °C reduction is well demonstrated by life tests and is consistent with the Arrhenius equation of chemical activation and the activation energy for aluminum electrolytic capacitors. However, there is another school of thought that says the reaction rate at cooler temperatures slows more than predicted by the Arrhenius equation because only a growingly smaller portion of the molecules have the activation energy needed to break existing chemical bonds and form new ones. This collision theory puts a prefactor in the Arrhenius equation that enables much longer

calculated service-life capability at temperatures near room temperature. Use these predictions with caution because it is not validated by life test results.

Often Mv is neglected, and values for the other variables calculated service-life capability at temperatures near room temperature. Use these predictions with caution because it is not validated by life test results. change by case size. Typical values for L_b are 1000 to 2000 h for miniature types, 2000 to 10,000 h for snap-in types and 2000 to 20,000 h for large-can screw terminal types. L_b can be greater than the rated load life because no ripple is applied and because it's typical life rather than minimum. Often T_m is 95 °C when rated temperature is 85 °C and is 108 to 110 °C when it's 105 °C.

Mv based on life tests for Cornell Dubilier capacitor types is:

$$Mv = 4.3 - 3.3V_a/V_r$$

where V_a is applied voltage and V_r is rated voltage. Values for L_b and T_m are:

Type	Lb	Tm
330	12000 h	108 °C
401C/101C	8000 h	108 °C
300/301	6000 h	108 °C
380L/LX	5000 h	90 °C
381L/LX	5000 h	110 °C
400C/500C/500R	7500 h	98 °C
420C/520C	12000 h	103 °C
450C/550C	15000 h	108 °C
DCMC	5000 h	95 °C
MLP up to 250V	12000 h	88 °C
MLP 300V & up	5000 h	88 °C
MLS	4000 h	125 °C
SLP	4500 h	110 °C
SLPX	4500 h	90 °C

Determining Operating Life

Determine expected operating life by calculating the capacitor's expected operating temperature, T_a , and then use the operating-life formula. The operating temperature is the expected average ambient temperature plus temperature rise from ripple current and leakage current. Leakage-current power is small compared to ripple-current power and can be neglected. Measure temperature rise from ripple current using sample capacitors with thermocouples installed at the core hotspot, or calculate temperature rise from dissipated power. If you calculate the power, do so at each significant ripple frequency and add the powers together for total power. Use the **Thermal Resistance Chart** to determine temperature rise. It's equal to power multiplied by thermal resistance.

Calculating power at a frequency other than 120 Hz requires knowing the ESR at the new frequency. You may infer the ESR value from the ripple-current frequency multipliers for each type.

$$ESR_f = ESR_{120} / Mf^2$$

Where ESR_f = ESR at a frequency f , ESR_{120} = ESR at 120 Hz and Mf = Frequency multiplier for frequency f .

Or you may calculate the new ESR using the equation in **ESR Frequency Characteristics**. Using that equation to solve for ESR_{f_r} and including 3% for DF_{f_r} ,

$$ESR_f = ESR_{120} - 39800(f - 120)/fC$$

Where ESR is in mΩ, f is in Hz and C is in μF. Although 3% is at the high end for DF_{f_r} , it fits with ESR_{120} which is a maximum limit for the ESR at 120 Hz.

Besides knowing ESR at the new frequency you also need to know the ESR at a new temperature, the expected operating temperature. For Cornell Dubilier capacitors with electrolytes rated to -40 °C this table shows representative ratios of ESR at elevated temperatures to ESR at 25 °C.

Rated Voltage	Capacitor Temperature		
	45 °C	65 °C	85 °C
Vdc	Ratio to ESR at 25 °C		
Up to 150	82%	77%	77%
200 to 300	75%	70%	70%
350 & 450	70%	60%	60%
500	61%	49%	45%

Here's an illustration to unify this information: Consider the earlier example, a 4700 μF, 450 V capacitor in a 3 inch (76 mm) diameter and 5 5/8 inches (143 mm) long can with a maximum ESR at 25 °C and 120 Hz of 30 mΩ. Suppose that the capacitor is used as a bus capacitor in a motor-drive inverter, and the ripple current consists of 11 A at 360 Hz and 6.5 A at 8000 Hz. And the average applied voltage, the bus voltage, is 390 Vdc.

First calculate the ESRs at the two frequencies. While you would use one or the other of the methods above to calculate ESR, here we'll use both to illustrate. If the capacitor is a Type DCMC, the frequency multiplier for 360 Hz is 1.13. Thus the 360 Hz ESR is $30/1.13^2$ or 23.5 mΩ. Or using the **ESR Frequency Characteristics** equation, the 360 Hz ESR is $[30 - 39800(360-120)/360/4700]$ or 24.4 mΩ. Similarly at 8000 Hz the ESRs calculate to be 19.5 and 21.6 mΩ.

Next calculate the total power. At 360 Hz it's $(11^2)(0.0244)$ or 2.9 W. At 8000 Hz it's $(6.5^2)(0.0216)$ or 0.9 W. That's a total power of 3.8 W.

Then calculate the core hot-spot temperature. From the **Thermal Resistance Chart** the thermal resistance for free convection cooling is 3.07 °C/W. So the temperature rise is $(3.8)(3.07)$ or 14 °C. If the ambient temperature were 50 °C, the core temperature would be 64 °C.

Now predict operating life capability using the **Operating Life** equation. The voltage multiplier, M_v is $[4.3 - 3.3(390/450)]$ or 1.44. Operating life is

$$\begin{aligned} \text{Lop} &= (1.44)(5000)2^{[(95 - 64)/10]} \\ &= 61,700 \text{ h} \end{aligned}$$

But if the core temperature is 64 °C, the ESR would have decreased about 40%. The new total power would be $0.6(3.8)$ or 2.3 W. The new temperature rise would be $(3.07)(2.3)$ or 7 °C, and the core temperature would be 57 °C. Recalculating operating life with the lower core temperature gives.

$$\begin{aligned} \text{Lop} &= (1.44)(5000)2^{[(95 - 57)/10]} \\ &= 100,300 \text{ h} \end{aligned}$$

And actual ESRs are typically 70% of limit so you could argue that the total power is 1.6 W. Thus the temperature rise would be 5 °C, the core temperature, 55 °C, and the operating life, 115,000 h. However, it is more accurate to use the maximum limit because that takes into account the ESR increase over life.

The example lower left shows the iterative approach. If a higher core temperature gives the operating life you require, you are done.

If the math needed to calculate operating life seems burdensome, take cheer. You can shortcut the calculations and consider more mounting and cooling options by using our Java applet on our website, <http://www.cde.com>.

Transient Over-Temperature

As said, life of aluminum electrolytic capacitors generally doubles for each 10 °C that the core temperature is reduced. The core is the hottest spot at about the center of the capacitor. However, as a capacitor heats up toward its maximum permitted core temperature, the rules change. At temperatures above the maximum core temperature and by 125 °C for most types the electrolyte can be driven from capacitor element and the ESR can increase as much as 10 times. By this mechanism, transient over-temperature or over-current can permanently increase the ESR and make the capacitor unusable. Be alert to this possibility in high-temperature and high-ripple applications, and pay extra attention to system cooling.

Load Life Test

Place the capacitors in a circulating air oven set to the upper temperature limit, 85 °C, 105°C or 125 °C, ±3 °C. Apply a DC voltage and an AC ripple voltage. Adjust the AC voltage to cause current equal to the rated ripple current to flow and adjust the DC voltage such that the peak voltage equals the capacitors' rated voltage. Apply the voltage for the rated load-life period -0 +6 h. Upon completion allow the capacitors to stabilize at 25 °C for 24 h or more. The capacitors will meet the specified post-test limits for capacitance, ESR and DCL.

EIA Ripple Life Test, EIA IS-479

Conduct the wear-out lifetime test per EIA Interim Standard 479. The highlights of that test are as follows:

Apply ripple current at 120 Hz or adjust to maintain the same power dissipation if performed at another frequency. Set DC bias voltage equal to rated voltage minus peak applied AC voltage. Set ambient temperature to 85 ± 2 °C with airflow less than 0.5 m/s. Periodic test interval ≤ 1000 h. Sample size is 10 or more. Mount capacitors horizontally and spaced 25 mm or more. Choose any temperature ≤ 85 °C for measurements, and make all measurements at that temperature. End of Lifetime is ≤ the time when 10% or more of the sample have

- capacitance < 80% initial value or
- ESR > 200% initial requirement or
- DCL > initial value or
- there is evidence of mechanical damage or leakage of electrolyte.

10% of sample may fail short or open and not be counted.

Voltage Derating

Voltage derating is expressed as the percentage that the applied voltage is less than rated voltage, e.g., a 450 V capacitor operating at 400 V would have 11% voltage derating.

Aluminum electrolytic capacitors made with formation voltages at least 35% higher than rated voltage and with rated temperatures of 85 °C or higher, don't require much voltage derating. In applications operating at less than 45 °C no derating is needed, and with up to 75 °C, 10% is sufficient. For higher temperatures and with high ripple current, 15% or 20% is appropriate. Since operating life continues to increase for further derating, military and space applications use 50% voltage derating.

Photoflash capacitors may be used at full rated voltage at normal room temperatures because they are designed for such duty. Strobe capacitors benefit from at least 10% voltage derating because their continuous operation makes them run hot.

SHELF LIFE

Aluminum electrolytic capacitors stored for more than 5 to 10 years may have increased levels of DC leakage current. Check if DCL meets application requirements before placing in service. Recondition high DCL units by applying rated voltage through 1,000 Ω resistor for 30 minutes.

Shelf life is a measure of how the capacitors will withstand storage for long times especially at high temperature. To test shelf life place the capacitors in an oven set to the shelf-life test temperature $-0 +3$ °C for the shelf-life test period. Upon completion of the test stabilize the capacitors at 25 °C for 24 h or more. Apply the rated voltage for 30 minutes, then verify the post test limits. Unless otherwise specified the capacitance, DCL and ESR will meet initial requirements.

COOLING AND THERMAL RESISTANCE

Cooling Strategies

Cornell Dubilier screw-terminal capacitors conduct heat from

the core to the bottom much more effectively than out the sides. You can take advantage of this heat path by mounting the capacitors directly to a metal chassis. In many case sizes this can double the permitted ripple current for the same temperature rise.

Mounting can be by using capacitors with mounting studs and screwing the capacitors directly to the plate or it can be by pressing the capacitors against a plate using the interconnecting bus structure. Cornell Dubilier furnishes silpad inserts at the bottom of the capacitors for this application. The silpads create smooth bottoms by eliminating the steps at the sleeve rollovers. The thermal resistance between the can and the underlying plate for capacitors merely sitting on the plate is about 2.5 °C/W. This decreases to less than 1 °C/W if the capacitors are pressed in place. Recommended vertical mounting force is 100 pounds. A Java applet is available on the Cornell Dubilier website which permits you to explore cooling options and directly see the affect on operating life. Go to <http://www.cde.com>.

Thermal Resistance

In large-can capacitors there can be significant temperature rise from the case to the core, the hottest spot at the center of the capacitor. For Cornell Dubilier Thermal Pak screw-terminal capacitors use the following thermal resistance data to determine temperature rise from power dissipated. As an illustration, consider 20 amps of ripple current at 120 Hz in a 3 x 5 5/8 case with a maximum ESR of 20 m Ω . The hot, typical ESR would be about half that or 10 m Ω , and the power dissipated would be I^2R_s , $20^2 \times 0.01$ or 4 W. For the DF case code the table shows that the thermal resistance from core to bottom of the can is about 0.41 °C/W. That varies a little depending on how the capacitor is cooled, but 0.41 °C/W predicts a temperature rise of 1.6 °C for 4 W. The free-convection cooling column shows a total thermal resistance of 3.07 °C/W for air on all sides and 1.02 °C/W for the capacitor pressed against a large metal plate or chassis. The 3.07 °C/W predicts a temperature rise of 12.3 °C, and 1.02 °C/W predicts 4.1 °C.

Thermal Resistance °C/W Thermal Pak Screw Terminal Aluminum Electrolytic Capacitors

Case Code	Case Size D x L (in)	Free Convection						200 lfm Airflow					
		Air on Side & End			Air & Metal Chassis			Air on Side & End			Air & Metal Chassis		
		Core to bottom	Case to air	Total	Core to bottom	Case to air	Total	Core to bottom	Case to air	Total	Core to bottom	Case to air	Total
AK	1 3/8 X 1 5/8	1.67	17.12	18.78	1.68	3.29	4.97	1.66	12.19	13.86	1.68	3.08	4.76
AA	1 3/8 X 2 1/8	1.70	13.72	15.42	1.74	3.13	4.87	1.70	9.80	11.50	1.74	2.90	4.64
AH	1 3/8 X 2 5/8	1.72	11.49	13.21	1.78	2.99	4.77	1.72	8.23	9.94	1.77	2.73	4.51
AB	1 3/8 X 3 1/8	1.72	9.91	11.63	1.80	2.86	4.66	1.71	7.12	8.83	1.79	2.59	4.38
AJ	1 3/8 X 3 5/8	1.69	8.73	10.43	1.81	2.74	4.55	1.69	6.29	7.99	1.80	2.46	4.25
AC	1 3/8 X 4 1/8	1.66	7.82	9.48	1.81	2.63	4.44	1.66	5.65	7.32	1.79	2.33	4.13
AD	1 3/8 X 4 5/8	1.62	7.09	8.71	1.80	2.52	4.32	1.62	5.14	6.76	1.78	2.22	4.00
AE	1 3/8 X 5 1/8	1.58	6.49	8.07	1.79	2.42	4.21	1.58	4.72	6.30	1.76	2.12	3.88
AF	1 3/8 X 5 5/8	1.53	5.99	7.52	1.77	2.33	4.10	1.53	4.37	5.90	1.74	2.02	3.76
EA	1 3/4 X 2 1/8	1.03	10.40	11.43	1.05	1.90	2.96	1.03	7.43	8.46	1.05	1.79	2.84
EH	1 3/4 X 2 5/8	1.06	8.77	9.83	1.09	1.84	2.93	1.06	6.28	7.34	1.09	1.71	2.80
EB	1 3/4 X 3 1/8	1.08	7.61	8.68	1.13	1.77	2.90	1.08	5.47	6.55	1.12	1.64	2.76
EJ	1 3/4 X 3 5/8	1.08	6.73	7.82	1.15	1.72	2.87	1.08	4.86	5.94	1.15	1.57	2.72
EC	1 3/4 X 4 1/8	1.08	6.06	7.13	1.17	1.66	2.83	1.08	4.39	5.47	1.16	1.51	2.67
ED	1 3/4 X 4 5/8	1.07	5.51	6.58	1.19	1.61	2.79	1.07	4.01	5.08	1.17	1.45	2.62
EE	1 3/4 X 5 1/8	1.05	5.07	6.12	1.19	1.55	2.75	1.05	3.70	4.75	1.18	1.39	2.57
EF	1 3/4 X 5 5/8	1.03	4.69	5.72	1.20	1.50	2.70	1.03	3.43	4.47	1.18	1.34	2.52
BA	2 X 2 1/8	0.78	8.89	9.67	0.80	1.45	2.24	0.78	6.35	7.14	0.80	1.37	2.17
BH	2 X 2 5/8	0.81	7.53	8.34	0.84	1.40	2.24	0.81	5.40	6.21	0.83	1.32	2.15
BB	2 X 3 1/8	0.83	6.55	7.38	0.87	1.36	2.23	0.83	4.71	5.54	0.87	1.27	2.13
BJ	2 X 3 5/8	0.84	5.82	6.66	0.90	1.32	2.22	0.84	4.20	5.04	0.89	1.22	2.11
BC	2 X 4 1/8	0.85	5.24	6.09	0.92	1.28	2.20	0.85	3.80	4.65	0.91	1.18	2.09
BD	2 X 4 5/8	0.84	4.78	5.63	0.93	1.25	2.18	0.84	3.48	4.33	0.93	1.14	2.07
BE	2 X 5 1/8	0.84	4.40	5.24	0.95	1.21	2.16	0.84	3.22	4.06	0.94	1.10	2.04
BF	2 X 5 5/8	0.83	4.09	4.92	0.96	1.18	2.14	0.83	3.00	3.83	0.94	1.06	2.01
CH	2 1/2 X 2 5/8	0.52	5.80	6.32	0.53	0.89	1.42	0.52	4.16	4.68	0.53	0.85	1.38
CB	2 1/2 X 3 1/8	0.54	5.07	5.61	0.56	0.87	1.43	0.54	3.65	4.19	0.56	0.82	1.38
CJ	2 1/2 X 3 5/8	0.55	4.53	5.08	0.58	0.85	1.43	0.55	3.27	3.82	0.58	0.80	1.38
CC	2 1/2 X 4 1/8	0.56	4.10	4.66	0.60	0.83	1.43	0.56	2.98	3.54	0.60	0.78	1.38
CD	2 1/2 X 4 5/8	0.57	3.47	4.04	0.64	0.79	1.43	0.57	2.55	3.11	0.63	0.74	1.37
CD	2 1/2 X 5 1/8	0.57	3.47	4.04	0.64	0.79	1.43	0.57	2.55	3.11	0.63	0.74	1.37
CF	2 1/2 X 5 5/8	0.57	3.23	3.80	0.65	0.78	1.43	0.57	2.38	2.95	0.64	0.72	1.36
DB	3 X 3 1/8	0.37	4.10	4.47	0.39	0.61	0.99	0.37	2.95	3.33	0.39	0.58	0.97
DJ	3 X 3 5/8	0.39	3.67	4.06	0.41	0.59	1.00	0.39	2.66	3.04	0.41	0.56	0.97
DC	3 X 4 1/8	0.40	3.34	3.73	0.43	0.58	1.01	0.40	2.43	2.82	0.42	0.55	0.97
DC	3 X 4 5/8	0.40	3.34	3.73	0.43	0.58	1.01	0.40	2.43	2.82	0.42	0.55	0.97
DE	3 X 5 1/8	0.41	2.85	3.26	0.46	0.56	1.02	0.41	2.09	2.50	0.45	0.53	0.98
DF	3 X 5 5/8	0.41	2.66	3.07	0.47	0.55	1.02	0.41	1.96	2.37	0.46	0.51	0.98
DP	3 X 5 7/8	0.41	2.58	2.99	0.47	0.55	1.02	0.41	1.91	2.32	0.47	0.51	0.98
DG	3 X 8 5/8	0.40	1.95	2.35	0.52	0.49	1.01	0.40	1.47	1.87	0.51	0.45	0.96
FC	3 1/2 X 4 1/8	0.30	2.79	3.09	0.32	0.43	0.75	0.30	2.03	2.33	0.31	0.41	0.72
FD	3 1/2 X 4 5/8	0.30	2.58	2.88	0.33	0.42	0.75	0.30	1.88	2.19	0.33	0.40	0.73
FE	3 1/2 X 5 1/8	0.31	2.40	2.71	0.34	0.42	0.76	0.31	1.76	2.07	0.34	0.39	0.73
FF	3 1/2 X 5 5/8	0.31	2.24	2.56	0.35	0.41	0.76	0.31	1.66	1.97	0.35	0.39	0.74
FP	3 1/2 X 5 7/8	0.31	2.18	2.49	0.36	0.41	0.77	0.32	1.61	1.93	0.36	0.38	0.74
FG	3 1/2 X 8 5/8	0.31	1.67	1.98	0.40	0.37	0.78	0.31	1.26	1.58	0.40	0.34	0.74

Thermal Resistance °C/W Thermal Pak Screw Terminal Aluminum Electrolytic Capacitors

Case Code	Case Size D x L (in)	500 lfm Airflow						1000 lfm Airflow					
		Air on Side & End			Air & Metal Chassis			Air on Side & End			Air & Metal Chassis		
		Core to bottom	Case to air	Total	Core to bottom	Case to air	Total	Core to bottom	Case to air	Total	Core to bottom	Case to air	Total
AK	1 3/8 X 1 5/8	1.66	7.83	9.49	1.68	2.75	4.43	1.66	5.62	7.29	1.68	2.46	4.14
AA	1 3/8 X 2 1/8	1.70	6.31	8.02	1.73	2.53	4.26	1.70	4.56	6.26	1.73	2.22	3.95
AH	1 3/8 X 2 5/8	1.72	5.33	7.05	1.76	2.35	4.11	1.72	3.87	5.59	1.76	2.04	3.79
AB	1 3/8 X 3 1/8	1.71	4.64	6.35	1.78	2.19	3.97	1.71	3.39	5.11	1.77	1.88	3.65
AJ	1 3/8 X 3 5/8	1.69	4.13	5.82	1.78	2.05	3.83	1.69	3.04	4.73	1.76	1.75	3.52
AC	1 3/8 X 4 1/8	1.66	3.73	5.39	1.77	1.93	3.70	1.66	2.76	4.42	1.75	1.64	3.39
AD	1 3/8 X 4 5/8	1.62	3.41	5.03	1.75	1.82	3.57	1.62	2.54	4.16	1.72	1.54	3.27
AE	1 3/8 X 5 1/8	1.58	3.15	4.73	1.72	1.73	3.45	1.58	2.36	3.93	1.70	1.46	3.15
AF	1 3/8 X 5 5/8	1.53	2.93	4.46	1.69	1.64	3.33	1.53	2.20	3.73	1.66	1.38	3.04
EA	1 3/4 X 2 1/8	1.03	4.79	5.83	1.05	1.61	2.66	1.03	3.46	4.50	1.05	1.45	2.49
EH	1 3/4 X 2 5/8	1.06	4.08	5.14	1.09	1.51	2.60	1.06	2.97	4.03	1.08	1.35	2.43
EB	1 3/4 X 3 1/8	1.08	3.57	4.65	1.12	1.43	2.55	1.08	2.62	3.69	1.11	1.26	2.37
EJ	1 3/4 X 3 5/8	1.08	3.20	4.28	1.14	1.36	2.50	1.08	2.36	3.44	1.13	1.19	2.32
EC	1 3/4 X 4 1/8	1.08	2.91	3.99	1.15	1.29	2.44	1.08	2.16	3.24	1.14	1.13	2.27
ED	1 3/4 X 4 5/8	1.07	2.67	3.74	1.16	1.23	2.39	1.07	2.00	3.07	1.14	1.07	2.21
EE	1 3/4 X 5 1/8	1.05	2.48	3.54	1.16	1.18	2.33	1.05	1.87	2.92	1.14	1.02	2.16
EF	1 3/4 X 5 5/8	1.03	2.32	3.35	1.15	1.13	2.28	1.03	1.76	2.79	1.13	0.97	2.11
BA	2 X 2 1/8	0.78	4.10	4.88	0.79	1.25	2.04	0.78	2.97	3.75	0.79	1.14	1.93
BH	2 X 2 5/8	0.81	3.50	4.32	0.83	1.18	2.01	0.81	2.55	3.36	0.83	1.07	1.89
BB	2 X 3 1/8	0.83	3.08	3.91	0.86	1.13	1.99	0.83	2.26	3.09	0.86	1.01	1.86
BJ	2 X 3 5/8	0.84	2.77	3.61	0.88	1.07	1.96	0.84	2.05	2.89	0.88	0.95	1.83
BC	2 X 4 1/8	0.85	2.52	3.37	0.90	1.03	1.93	0.85	1.88	2.73	0.89	0.91	1.80
BD	2 X 4 5/8	0.84	2.33	3.17	0.91	0.99	1.90	0.84	1.75	2.59	0.90	0.87	1.77
BE	2 X 5 1/8	0.84	2.17	3.01	0.92	0.95	1.87	0.84	1.64	2.48	0.91	0.83	1.74
BF	2 X 5 5/8	0.83	2.03	2.86	0.93	0.91	1.84	0.83	1.55	2.38	0.91	0.80	1.71
CH	2 1/2 X 2 5/8	0.52	2.70	3.22	0.53	0.78	1.31	0.52	1.97	2.49	0.53	0.71	1.24
CB	2 1/2 X 3 1/8	0.54	2.39	2.93	0.55	0.75	1.30	0.54	1.76	2.29	0.55	0.68	1.23
CJ	2 1/2 X 3 5/8	0.55	2.16	2.71	0.58	0.72	1.30	0.55	1.60	2.15	0.57	0.65	1.23
CC	2 1/2 X 4 1/8	0.56	1.98	2.54	0.59	0.70	1.29	0.56	1.48	2.04	0.59	0.63	1.22
CD	2 1/2 X 4 5/8	0.57	1.72	2.29	0.62	0.65	1.27	0.57	1.31	1.88	0.62	0.58	1.20
CD	2 1/2 X 5 1/8	0.57	1.72	2.29	0.62	0.65	1.27	0.57	1.31	1.88	0.62	0.58	1.20
CF	2 1/2 X 5 5/8	0.57	1.62	2.19	0.63	0.63	1.26	0.57	1.24	1.81	0.62	0.56	1.19
DB	3 X 3 1/8	0.37	1.94	2.31	0.39	0.53	0.92	0.37	1.42	1.80	0.38	0.49	0.88
DJ	3 X 3 5/8	0.39	1.76	2.14	0.40	0.52	0.92	0.39	1.30	1.69	0.40	0.47	0.88
DC	3 X 4 1/8	0.40	1.62	2.02	0.42	0.50	0.92	0.40	1.21	1.61	0.42	0.46	0.88
DC	3 X 4 5/8	0.40	1.62	2.02	0.42	0.50	0.92	0.40	1.21	1.61	0.42	0.46	0.88
DE	3 X 5 1/8	0.41	1.42	1.83	0.45	0.47	0.92	0.41	1.08	1.49	0.44	0.43	0.88
DF	3 X 5 5/8	0.41	1.34	1.76	0.46	0.46	0.92	0.41	1.03	1.44	0.45	0.42	0.87
DP	3 X 5 7/8	0.41	1.31	1.72	0.46	0.46	0.92	0.41	1.01	1.42	0.46	0.41	0.87
DG	3 X 8 5/8	0.40	1.05	1.45	0.50	0.39	0.89	0.40	0.83	1.23	0.48	0.36	0.84
FC	3 1/2 X 4 1/8	0.30	1.36	1.65	0.31	0.38	0.69	0.30	1.02	1.31	0.31	0.35	0.66
FD	3 1/2 X 4 5/8	0.30	1.27	1.57	0.32	0.37	0.69	0.30	0.96	1.26	0.32	0.34	0.66
FE	3 1/2 X 5 1/8	0.31	1.20	1.51	0.34	0.36	0.70	0.31	0.91	1.22	0.33	0.33	0.67
FF	3 1/2 X 5 5/8	0.31	1.14	1.45	0.35	0.35	0.70	0.31	0.87	1.19	0.34	0.33	0.67
FP	3 1/2 X 5 7/8	0.32	1.11	1.43	0.35	0.35	0.70	0.32	0.86	1.17	0.35	0.32	0.67
FG	3 1/2 X 8 5/8	0.32	0.91	1.22	0.39	0.31	0.70	0.32	0.72	1.04	0.38	0.28	0.66

Thermal Resistance Chart °C/W Snap-in Aluminum Electrolytic Capacitors

Case Code	Case Size DxL(mm)	Free Convection			200 lfm Airflow			500 lfm Airflow			1000 lfm Airflow		
		core to case	case to air	total	core to case	case to air	total	core to case	case to air	total	core to case	case to air	total
H01	22 x 25	7.92	22.46	30.38	7.90	13.05	20.96	7.89	8.31	16.20	7.87	5.78	13.64
H02	22 x 30	8.13	20.02	28.15	8.11	11.75	19.87	8.09	7.58	15.67	8.06	5.34	13.41
H03	22 x 35	8.33	18.15	26.48	8.31	10.78	19.08	8.28	7.05	15.32	8.24	5.04	13.28
H04	22 x 40	8.51	16.69	25.20	8.48	10.03	18.51	8.44	6.65	15.09	8.39	4.83	13.22
H05	22 x 50	8.83	14.56	23.39	8.79	8.97	17.75	8.73	6.12	14.85	8.66	4.56	13.22
J01	25 x 25	6.11	18.99	25.10	6.10	11.04	17.14	6.08	7.03	13.11	6.06	4.89	10.95
J02	25 x 30	6.32	17.01	23.33	6.30	9.99	16.29	6.28	6.44	12.72	6.25	4.54	10.79
J03	25 x 35	6.52	15.49	22.00	6.49	9.20	15.69	6.46	6.01	12.47	6.42	4.30	10.72
J04	25 x 40	6.70	14.29	20.99	6.67	8.59	15.26	6.63	5.70	12.32	6.58	4.13	10.71
J45	25 x 45	6.87	13.32	20.19	6.83	8.11	14.94	6.78	5.46	12.24	6.72	4.02	10.73
J05	25 x 50	7.03	12.54	19.57	6.98	7.73	14.71	6.92	5.27	12.20	6.85	3.93	10.78
K01	30 x 25	4.28	14.84	19.12	4.26	8.63	12.89	4.25	5.50	9.74	4.22	3.82	8.04
K02	30 x 30	4.46	13.40	17.86	4.44	7.87	12.31	4.41	5.08	9.49	4.38	3.58	7.96
K03	30 x 35	4.63	12.27	16.91	4.61	7.29	11.90	4.57	4.77	9.34	4.53	3.41	7.94
K04	30 x 40	4.80	11.38	16.18	4.77	6.84	11.61	4.73	4.54	9.26	4.67	3.29	7.96
K45	30 x 45	4.96	10.66	15.62	4.92	6.49	11.41	4.87	4.37	9.23	4.80	3.21	8.01
K05	30 x 50	5.12	10.07	15.19	5.07	6.21	11.28	5.00	4.23	9.24	4.92	3.15	8.07
A01	35 x 25	3.19	11.98	15.18	3.18	6.97	10.15	3.16	4.44	7.60	3.14	3.09	6.22
A02	35 x 30	3.35	10.89	14.24	3.33	6.40	9.73	3.31	4.13	7.43	3.28	2.91	6.18
A03	35 x 35	3.51	10.03	13.53	3.48	5.96	9.44	3.45	3.89	7.34	3.40	2.78	6.18
A04	35 x 40	3.66	9.34	13.00	3.62	5.62	9.24	3.58	3.72	7.30	3.52	2.69	6.22
A45	35 x 45	3.80	8.78	12.58	3.76	5.35	9.10	3.70	3.59	7.29	3.64	2.63	6.27
A05	35 x 50	3.94	8.32	12.26	3.89	5.13	9.02	3.82	3.49	7.31	3.74	2.59	6.33
A06	35 x 63	4.26	7.46	11.72	4.19	4.75	8.94	4.09	3.34	7.43	3.98	2.54	6.53
A08	35 x 80	4.63	6.76	11.39	4.52	4.48	9.00	4.38	3.26	7.64	4.23	2.54	6.78
A10	35 x 105	5.03	6.19	11.21	4.87	4.30	9.17	4.69	3.24	7.93	4.49	2.59	7.08
N04	40 x 40	2.90	7.84	10.74	2.87	4.71	7.58	2.82	3.12	5.94	2.77	2.25	5.02
N05	40 x 50	3.15	7.03	10.18	3.10	4.33	7.43	3.04	2.94	5.98	2.96	2.18	5.14
N06	40 x 63	3.45	6.34	9.79	3.37	4.03	7.41	3.28	2.83	6.11	3.17	2.14	5.31
N08	40 x 80	3.79	5.78	9.57	3.68	3.83	7.50	3.54	2.77	6.31	3.39	2.15	5.54
N10	40 x 105	4.18	5.33	9.51	4.02	3.70	7.71	3.83	2.77	6.60	3.63	2.19	5.83
B05	50 x 50	2.20	5.25	7.45	2.15	3.23	5.38	2.09	2.19	4.27	2.01	1.61	3.62
B06	50 x 63	2.44	4.79	7.23	2.37	3.04	5.40	2.27	2.11	4.39	2.17	1.59	3.76
B08	50 x 80	2.72	4.41	7.14	2.61	2.90	5.52	2.48	2.08	4.56	2.34	1.60	3.94
B09	50 x 92	2.90	4.24	7.14	2.76	2.86	5.62	2.60	2.09	4.69	2.44	1.61	4.06
B10	50 x 105	3.07	4.12	7.18	2.90	2.83	5.74	2.72	2.10	4.81	2.53	1.63	4.17

PROCESS CONSIDERATIONS

SOLDERING

Preheat

Don't exceed the maximum storage temperature while preheating the capacitors. If this cannot be avoided, contact the supplier first.

Temperature and Duration

Strictly adhere to soldering conditions for temperature, duration and minimum distance of solder from body. Don't contact insulating sleeve or other plastic parts with a soldering iron or molten solder. Reflow solder only SMT types, and then only one reflow cycle. Contact the supplier if more than one reflow is necessary.

Care after Soldering

Do not exert any mechanical force like bending, straightening, twisting or tilting of capacitors after soldering into a printed circuit board.

Handling Assembled Devices

During transport and handling of assembled devices do not misuse capacitors as a handle. Ensure that capacitors are protected from physical damage during mounting of printed circuit boards into assemblies or during stacking.

Halogenated-Solvent Cleaning

Halogenated hydrocarbon solvents (CFC) are ozone depleting chemicals harmful to the environment. Such solvents can penetrate the capacitors' seals and cause corrosion and failure when voltage is applied, and so use them to clean aluminum electrolytic capacitors only to the limited conditions given by the component supplier and then only as a last resort. Solvent-proof miniature capacitors and capacitors with epoxy endseals are available for limited use with halogenated solvents.

Aqueous Cleaning

Water with a mild detergent may be used to clean aluminum electrolytic capacitors. However, immediately dry the capacitors in hot air at about 85 °C for 5 or more minutes but not hotter than the capacitors' maximum storage temperature. Water can become trapped beneath the sleeve which may not be dispelled by evaporation at room temperature. Water can be trapped under the sleeve and cause hydration and discoloration of the aluminum cases; although this does not affect capacitor operation.

Alcohol Cleaning

Alcohol solvents like isopropanol, methanol, ethanol and propanol have no harmful affects on aluminum electrolytic capacitors. While they are fine for cleaning, they are not very effective in removal of commercial soldering fluxes.

Cleaning Precautions

The capacitor's insulating sleeve may re-shrink or crack if rapidly heated to above 100 °C just after cleaning. If the solder flux contains chlorine as many active flux types do, frequently regenerate or replace the cleaning solvent to avoid damaging the capacitors. Cleaning solvents may swell the insulating sleeves and affect the legibility of marking if applied too long or with too high mechanical forces or temperatures.

Potting and Gluing

Be certain that varnishing, coating, lacquering, embedding and gluing near the capacitors' seals are halogen free. And be sure all constituent parts including base material, thinners, binders, reacting agents, propellants and additives are halogen free. If the printed circuit board has been cleaned with halogenated solvent, be sure it's fully dry before installation of capacitors. When gluing, don't apply glue to the full capacitor circumference, and don't cover the capacitors' pressure-relief vent with potting or glue.

Fumigation Warning

International shipments of electronic equipment are often in wooden crates, and these crates may be fumigated with methyl bromide gas during shipment to control insect infestation. Also, some factories such as flourmills are routinely fumigated with this gas. Methyl bromide can penetrate cardboard boxes, vinyl bags and other packaging materials used to protect the equipment. Methyl bromide can also penetrate the seals of aluminum electrolytic capacitors; cause corrosion and cause open-circuit capacitor failure after the equipment is put into service.

Beginning in 2005 methyl bromide use has been limited to applications with EPA Critical Use Exemptions for specific agricultural and food-processing use.

To protect aluminum electrolytic capacitors against such failures use capacitors proven to be able to withstand fumigation or individually sealed to prevent penetration of the methyl bromide gas. Screw terminal capacitors with rubber vent plugs are the most susceptible type.

MOUNTING

Mounting Position

Aluminum electrolytic capacitors have longer operating lives at lower ambient temperatures; so, put the capacitors at the coolest place on the board. Ensure that aluminum electrolytic capacitors are away from hot components like power resistors, power transistors or diodes and transformers. Adequately space components apart for cooling air to circulate. Ensure that aluminum electrolytic capacitors are away from hot components like power resistors, power transistors or diodes and transformers. Adequately space components apart for cooling air to circulate. This is especially important when high ripple current or charge/discharge loads are applied.

Mount screw-terminal capacitors upright with terminals up or horizontally with pressure-relief vent plug at the 12-O'clock position; so, the least amount of electrolyte will be expelled if the vent operates. Do not mount upside down with terminals down as this may reduce the operating life and could impair the operation of the pressure-relief vent.

Place the capacitors so that a person working on the equipment would be protected from the hot vapor in the event that a vent was to operate.

Horizontal Mounting

One maker of high voltage screw terminal aluminum electrolytic capacitors reports that if mounted horizontally, the positive terminal should be above the negative terminal to avoid corrosion. This is not needed with Cornell Dubilier capacitors, but if you advocate better safe than sorry, you can mount the capacitor with the vent plug at the 11-O'clock position, so the positive terminal would be higher.

For high-ripple-current applications of screw terminal aluminum electrolytic capacitors with extended paper, horizontal moun-

ting shortens the lifetime. With heating from ripple current the electrolyte in such capacitors may bleed from the winding, and puddle along the side of the can where there is no paper to wick it back into the winding. If the ripple current is low (less than half of rated 85 °C current), this is not an issue. But if the ripple current is high, the effect is accelerated due both to the increasing temperature driving the electrolyte out faster and to the drying of the wet paper where it is crushed into the can bottom. The drying of the paper can thermally insulate the element causing it to get hotter and the can bottom to get cooler. This can actually turn into a thermal runaway condition that can greatly reduce the capacitor lifetime, sometimes by as much as 90%.

The possible solutions are 1) to mount such capacitors upright, 2) use Thermal Pak construction with extended cathode foil, 3) use rilled construction with the element secured by dimples in the can wall, or use potted construction where the element is anchored with pitch. If the capacitor is upright, the electrolyte is able to readily wick back into the winding, and the thermal contact and ESR do not degrade significantly. Thermal runaway does not occur, and the expected lifetime is achieved.

If a Thermal Pak extended-cathode capacitor is mounted horizontally, the thermal insulation does not occur because the thermal contact never degrades. However, the lifetime may still be somewhat shortened because of electrolyte loss. Life reduction may be more than 10% with rated 85 °C ripple. Because the thermal contact does not degrade, there is no thermal runaway.

If a potted construction capacitor is mounted horizontally, increased heating does not occur because the electrolyte does not readily escape the winding, and the thermal contact never degrades. Potted construction has limited availability because of environmental issues and is currently not available in Cornell Dubilier capacitors.

Position of the Pressure-Relief Vent

Aluminum electrolytic capacitors with liquid electrolyte have pressure-relief vents. The vents are scored lines or patterns on the end or side of the cans or rubber plugs in the molded tops. Vents are designed to rupture, release gas and electrolyte vapor, and prevent possible explosion from pressure build up during capacitor abuse, e.g. overvoltage, reverse voltage or application of AC voltage.

Provide adequate clearance for proper operation of the pressure-relief vent. The following distances are a guide.

Nominal Case Diameter	Space around pressure relief device
< 16 mm	> 2 mm
> 16 mm to < 40 mm	> 3 mm
> 40 mm	> 5 mm

Mount the capacitors with the vents up to reduce the amount of electrolyte expelled if a vent operates.

Polarity indication

Aluminum electrolytic capacitors are normally polarized and

require correct-polarity installation in the circuitry. To ensure correct mounting and identification of the polarity, put a clear + and/or – on the board layout marking. If the circuit voltage can reverse polarity or is unknown, consider using non-polar capacitors. Disadvantages are that non-polar capacitors are larger and more expensive.

Printed-Circuit Board Precautions

Avoid positioning holes in places where parts of a capacitor could be on the other side and be touched by molten solder. Because the can and sometimes extra terminals of an aluminum electrolytic capacitor have resistive connections to the negative terminal through the electrolyte, don't locate tracks or lands under upright capacitors, don't permit metal capacitor parts other than active terminals to contact conductive tracks or other components, and leave dummy pins voltage free.

Handling Terminals

Before handling a capacitor be sure it is sufficiently discharged. To avoid damaging the capacitor, don't bend rigid terminals, and be sure to clamp the terminals during cutting or bending to avoid excess stress on terminations, welds and capacitor seals. Don't use extra force to insert capacitors. If they cannot be inserted easily, correct the problem. Discard capacitors showing signs of mechanical damage.

Screw-Terminal Torque

Excess torque during tightening screws into terminals may affect the performance of the capacitor or damage the terminal. The following torque settings are recommended. Be certain that at least six screw threads are engaged.

Terminal	Recommended Torque
10–32, Low Post	25 in-lb, 2.8 N-m
10–32, High Post	25 in-lb, 2.8 N-m
¼–28, Low Post	50 in-lb, 5.6 N-m
¼–28, High Post	60 in-lb, 6.8 N-m
Small M5 Post	25 in-lb, 2.8 N-m
M5 Post	30 in-lb, 3.4 N-m
M6 Low Post	50 in-lb, 5.6 N-m
M6 High Post	60 in-lb, 6.8 N-m

Screw-Terminal Current Rating

For normal operation the maximum recommended continuous AC currents for screw terminals are as tabulated below.

Terminal	Maximum Current
10–32, Low Post	30 Aac
10–32, High Post	30 Aac
¼–28, Low Post	50 Aac
¼–28, High Post	50 Aac
Small M5 Post	30 Aac
M5 Post	35 Aac
M6 Low Post	50 Aac
M6 High Post	60 Aac

The ripple current ratings may exceed the currents listed here. Terminals can withstand continuous currents of more than double the maximum currents listed if you assure gas-tight connections to avoid formation of aluminum oxide. Use Belleville washers and a commercial electrical joint compound, e.g. Penetrox A, and tighten the terminals to the recommended torque for the washers.

Mounting-Stud Torque

Screw-terminal, capacitors are available with threaded mounting studs on the can bottoms, and nylon nuts are available for insulated mounting. The following torque settings are recommended.

Nylon Nut Thread	Recommended Torque
M8	25 in-lb, 2.8 N-m
M12	75 in-lb, 8.5 N-m

Notice and Disclaimer: All product drawings, descriptions, specifications, statements, information and data (collectively, the "Information") in this datasheet or other publication are subject to change. The customer is responsible for checking, confirming and verifying the extent to which the Information contained in this datasheet or other publication is applicable to an order at the time the order is placed. All Information given herein is believed to be accurate and reliable, but it is presented without any guarantee, warranty, representation or responsibility of any kind, expressed or implied. Statements of suitability for certain applications are based on the knowledge that the Cornell Dubilier company providing such statements ("Cornell Dubilier") has of operating conditions that such Cornell Dubilier company regards as typical for such applications, but are not intended to constitute any guarantee, warranty or representation regarding any such matter – and Cornell Dubilier specifically and expressly disclaims any guarantee, warranty or representation concerning the suitability for a specific customer application, use, storage, transportation, or operating environment. The Information is intended for use only by customers who have the requisite experience and capability to determine the correct products for their application. Any technical advice inferred from this Information or otherwise provided by Cornell Dubilier with reference to the use of any Cornell Dubilier products is given gratis (unless otherwise specified by Cornell Dubilier), and Cornell Dubilier assumes no obligation or liability for the advice given or results obtained. Although Cornell Dubilier strives to apply the most stringent quality and safety standards regarding the design and manufacturing of its products, in light of the current state of the art, isolated component failures may still occur. Accordingly, customer applications which require a high degree of reliability or safety should employ suitable designs or other safeguards (such as installation of protective circuitry or redundancies or other appropriate protective measures) in order to ensure that the failure of an electrical component does not result in a risk of personal injury or property damage. Although all product-related warnings, cautions and notes must be observed, the customer should not assume that all safety measures are indicated in such warnings, cautions and notes, or that other safety measures may not be required.

DISPOSAL OF CAPACITORS

Aluminum electrolytic capacitors with non-solid electrolyte principally include high-purity aluminum foils, capacitor paper, electrolyte, aluminum case, cover and sealing parts (phenolic, thermoplastic, rubber and phenolic board), insulating sleeve (polypropylene, polyester or polyvinylchloride) and, perhaps, safety-vent plugs made of synthetic rubber. If incinerated, be certain that the temperature is more than 1200 °C. Disposal is permitted in appropriate landfills.